

**User Manual**

# SOM-4463 A2

**ADVANTECH**

*Enabling an Intelligent Planet*

---

## Copyright

The documentation and the software included with this product are copyrighted 2014 by Advantech Co., Ltd. All rights are reserved. Advantech Co., Ltd. reserves the right to make improvements in the products described in this manual at any time without notice.

No part of this manual may be reproduced, copied, translated or transmitted in any form or by any means without the prior written permission of Advantech Co., Ltd. Information provided in this manual is intended to be accurate and reliable. However, Advantech Co., Ltd. assumes no responsibility for its use, nor for any infringements of the rights of third parties, which may result from its use.

## Acknowledgements

AMI is a trademark of American Megatrends Inc.

VIA is a trademark of VIA Technologies, Inc.

IBM, PC/AT, PS/2 and VGA are trademarks of International Business Machines Corporation.

Intel and Pentium are trademarks of Intel Corporation.

Microsoft Windows® is a registered trademark of Microsoft Corp.

RTL is a trademark of Realtek Semi-Conductor Co., Ltd.

ESS is a trademark of ESS Technology, Inc.

UMC is a trademark of United Microelectronics Corporation.

SMI is a trademark of Silicon Motion, Inc.

Creative is a trademark of Creative Technology LTD.

CHRONTEL is a trademark of Chrontel Inc.

All other product names or trademarks are properties of their respective owners.

## Product Warranty (2 years)

Advantech warrants to you, the original purchaser, that each of its products will be free from defects in materials and workmanship for two years from the date of purchase.

This warranty does not apply to any products which have been repaired or altered by persons other than repair personnel authorized by Advantech, or which have been subject to misuse, abuse, accident or improper installation. Advantech assumes no liability under the terms of this warranty as a consequence of such events.

Because of Advantech's high quality-control standards and rigorous testing, most of our customers never need to use our repair service. If an Advantech product is defective, it will be repaired or replaced at no charge during the warranty period. For out-of-warranty repairs, you will be billed according to the cost of replacement materials, service time and freight. Please consult your dealer for more details.

If you think you have a defective product, follow these steps:

1. Collect all the information about the problem encountered. (For example, CPU speed, Advantech products used, other hardware and software used, etc.) Note anything abnormal and list any onscreen messages you get when the problem occurs.
2. Call your dealer and describe the problem. Please have your manual, product, and any helpful information readily available.
3. If your product is diagnosed as defective, obtain an RMA (return merchandise authorization) number from your dealer. This allows us to process your return more quickly.
4. Carefully pack the defective product, a fully-completed Repair and Replacement Order Card and a photocopy proof of purchase date (such as your sales receipt) in a shippable container. A product returned without proof of the purchase date is not eligible for warranty service.
5. Write the RMA number visibly on the outside of the package and ship it prepaid to your dealer.

## Technical Support and Assistance

1. Visit the Advantech web site at [www.advantech.com/support](http://www.advantech.com/support) where you can find the latest information about the product.
2. Contact your distributor, sales representative, or Advantech's customer service center for technical support if you need additional assistance. Please have the following information ready before you call:
  - Product name and serial number
  - Description of your peripheral attachments
  - Description of your software (operating system, version, application software, etc.)
  - A complete description of the problem
  - The exact wording of any error messages

---

## Safety Instructions

1. Read these safety instructions carefully.
2. Keep this User Manual for later reference.
3. Disconnect this equipment from any AC outlet before cleaning. Use a damp cloth. Do not use liquid or spray detergents for cleaning.
4. For plug-in equipment, the power outlet socket must be located near the equipment and must be easily accessible.
5. Keep this equipment away from humidity.
6. Put this equipment on a reliable surface during installation. Dropping it or letting it fall may cause damage.
7. The openings on the enclosure are for air convection. Protect the equipment from overheating. **DO NOT COVER THE OPENINGS.**
8. Make sure the voltage of the power source is correct before connecting the equipment to the power outlet.
9. Position the power cord so that people cannot step on it. Do not place anything over the power cord.
10. All cautions and warnings on the equipment should be noted.
11. If the equipment is not used for a long time, disconnect it from the power source to avoid damage by transient overvoltage.
12. Never pour any liquid into an opening. This may cause fire or electrical shock.
13. Never open the equipment. For safety reasons, the equipment should be opened only by qualified service personnel.
14. If one of the following situations arises, get the equipment checked by service personnel:
  - The power cord or plug is damaged.
  - Liquid has penetrated into the equipment.
  - The equipment has been exposed to moisture.
  - The equipment does not work well, or you cannot get it to work according to the user's manual.
  - The equipment has been dropped and damaged.
  - The equipment has obvious signs of breakage.

## Safety Precaution - Static Electricity

Follow these simple precautions to protect yourself from harm and the products from damage.

- To avoid electrical shock, always disconnect the power from your PC chassis before you work on it. Don't touch any components on the CPU card or other cards while the PC is on.
- Disconnect power before making any configuration changes. The sudden rush of power as you connect a jumper or install a card may damage sensitive electronic components.

## Packing List

Before you begin installing your card, please make sure that the following materials have been shipped:

- 1 SOM-4463 module with heat spreader
- 1 User manual and drivers



# Contents

<b>Chapter 1</b>	<b>General Information .....</b>	<b>1</b>
1.1	Introduction .....	2
1.2	Specifications .....	2
1.2.1	Standard System On Module functions .....	2
1.2.2	VGA/flat panel Interface.....	2
1.2.3	Audio function .....	2
1.2.4	LAN LED Function .....	3
	Table 1.1: LAN LED Signaling and Behavior Default Settings ....	3
1.2.5	Mechanical and environmental specifications.....	3
<b>Chapter 2</b>	<b>Mechanical Information .....</b>	<b>5</b>
2.1	Board Connectors .....	6
	Figure 2.1 SOM-4463 Locating Connectors .....	6
2.2	Board Mechanical Drawing .....	6
2.2.1	Front Side .....	6
	Figure 2.2 SOM-4463 Front Side Drawing .....	6
2.2.2	Rear Side .....	7
	Figure 2.3 SOM-4463 Rear Side Drawing .....	7
<b>Chapter 3</b>	<b>BIOS Setup Information .....</b>	<b>9</b>
	Figure 3.1 Setup program initial screen .....	10
3.1	Entering Setup .....	10
3.2	Main Setup .....	11
	Figure 3.2 Main setup screen .....	11
3.2.1	System time / System date .....	11
3.3	Advanced BIOS Features Setup .....	12
	Figure 3.3 Advanced BIOS features setup screen .....	12
3.3.1	CPU Configuration .....	12
	Figure 3.4 CPU Configuration Setting .....	12
3.3.2	IDE Configuration.....	13
	Figure 3.5 IDE Configuration .....	13
3.3.3	Floppy Configuration .....	14
	Figure 3.6 Floppy Configuration .....	14
3.3.4	Super I/O Configuration .....	15
	Figure 3.7 Super I/O Configuration .....	15
3.3.5	Hardware Health Configuration.....	16
	Figure 3.8 Hardware Health Configuration .....	16
3.3.6	ACPI Settings.....	16
	Figure 3.9 ACPI Settings .....	16
	Figure 3.10General ACPI Configuration .....	17
	Figure 3.11Advanced ACPI Configuration .....	17
	Figure 3.12Chipset ACPI Configuration.....	18
3.3.7	AHCI Configuration .....	19
	Figure 3.13Advanced ACPI Configuration .....	19
3.3.8	APM Configuration .....	19
	Figure 3.14APM Configuration .....	19
3.3.9	Event Log Configuration .....	20
	Figure 3.15Event Log Configuration .....	20
3.3.10	MPS Configuration .....	21
	Figure 3.16MPS Configuration .....	21
3.3.11	Smbios Configuration.....	21

	Figure 3.17 Smbios Configuration .....	21
3.3.12	USB Configuration .....	22
	Figure 3.18 South Bridge ACPI Configuration .....	22
3.3.13	USB Mass Storage Device Configuration .....	23
	Figure 3.19 USB Mass storage Device Configuration .....	23
3.4	Advanced PCI/PnP Settings .....	23
	Figure 3.20 PCI/PNP Setup .....	23
3.5	Boot Settings .....	24
	Figure 3.21 Boot Setup Utility .....	24
3.5.1	Boot settings Configuration .....	25
	Figure 3.22 Boot Setting Configuration .....	25
3.6	Security Setup .....	26
	Figure 3.23 Password Configuration .....	26
3.7	Advanced Chipset Settings .....	27
	Figure 3.24 Advanced Chipset Settings .....	27
3.7.1	North Bridge Chipset Configuration .....	27
	Figure 3.25 North Bridge Configuration .....	27
	Figure 3.26 Video Function Configuration .....	28
3.7.2	South Bridge Chipset Configuration .....	29
	Figure 3.27 South Bridge Configuration .....	29
3.8	Exit Option .....	30
	Figure 3.28 Exit Option .....	30
3.8.1	Save Changes and Exit .....	30
3.8.2	Discard Changes and Exit .....	30
3.8.3	Load Optimal Defaults .....	30
3.8.4	Load Fail-Safe Defaults .....	30
<b>Chapter 4</b>	<b>Driver Installation .....</b>	<b>33</b>
4.1	Driver Introduction and Installation .....	34
<b>Appendix A</b>	<b>Watchdog Timer .....</b>	<b>35</b>
A.1	Programming the Watchdog Timer .....	36
<b>Appendix B</b>	<b>System Assignments .....</b>	<b>39</b>
B.1	System I/O Ports .....	40
	Table B.1: System I/O ports .....	40
B.2	DMA Channel Assignments .....	41
	Table B.2: DMA channel assignments .....	41
B.3	Interrupt Assignments .....	41
	Table B.3: Interrupt assignments .....	41
B.4	System Memory Map .....	42
	Table B.4: System Memory Map .....	42



# Chapter 1

## General Information

This chapter gives background information on the SOM-4463 CPU System on Module.

Sections include:

- Introduction
- Specifications

## 1.1 Introduction

SOM-4463 is an embedded CPU module that fully complies with the SOM-ETX form factor standard. The new CPU module supports Intel N450/D510 +ICH8M chipsets which supports PCI and ISA interfaces. In a basic form factor of 95mm x 114mm, the SOM-4463 provides a scalable cost effective and easy to integrate solution for customers applications by utilizing a plug-in CPU module on an application-specific customer solution board. The SOM-4463 with advanced I/O capacity incorporates PCI, ISA, IDE, USB 2.0, SATA and LVDS interfaces. SOM-4463 offers customers more choices for their own applications needing cost effective solutions while maintaining a compact form factor.

SOM-4463 complies with the "Green Function" standard and supports Doze, Standby and Suspend modes. The small size (95 mm x 114 mm) and use of four high capacity connectors based on the proven SOM-ETX form factor, allow the SOM-ETX modules to be easily and securely mounted onto a customized solution board or our standard SOM-DB4700 development board.

## 1.2 Specifications

### 1.2.1 Standard System On Module functions

- **CPU:** Intel N450 single core Processor  
Intel D510 Dual core Processor
- **BIOS:** AMI 16 Mbit Flash BIOS
- **Chipset:** Intel N450/D510+ICH8M
- **System memory:** DDR2 667 MHz up to 2GB (N450)  
DDR2 667 MHz up to 4GB (D510)
- **Enhanced IDE interface:** 1 x EIDE channel for two devices. BIOS auto-detect up to UDMA -100
- **Watchdog timer:** 256 timer intervals, from 1 to 255 seconds or minutes according to software setup, which features jumperless selection and enabling generation of system reset signal.
- **USB interface:** Supports 4 x USB 2.0 ports
- **Expansion Interface:** Supports PCI and ISA bus interfaces

### 1.2.2 VGA/flat panel Interface

- **Chipset:** Intel N450/D510
- **Memory Size:** DVMT 3.0 supports up to 128 MB
- **Display mode:**  
CRT Mode: Up to 1400 x 1050 (N450)  
Up to 2048 x 1536 (D510)  
LVDS Mode: Support 18-bit LVDS

### 1.2.3 Audio function

- **Audio interface:** Realtek ALC888 codec

## 1.2.4 LAN LED Function

Because of the variations in LAN chips, the behavior settings for the SOM-4463 A2 LAN LED have been changed, as shown in the table below.

**Table 1.1: LAN LED Signaling and Behavior Default Settings**

ETX-X4 Conn. Pin-out	SOM-4463 A1 LED Indicator	SOM-4463 A2 LED Indicator
<b>D10 (LILED#)</b> LED behavior	<b>LINK (10/100)</b> On indicates Link; off indicates non-Link	<b>LINK (100)</b> On indicates Link; off indicates non-Link/Link(10)
<b>D12 (ACTLED#)</b> LED behavior	<b>ACT (10/100)</b> Flashing indicates activation	<b>ACT (10/100)</b> Flashing indicates activation
<b>D14 (SPEEDLED#)</b> LED behavior	<b>LINK (10/100)</b> On denotes 10 and 100	<b>LINK (100)</b> On denotes 100 Off denotes 10

## 1.2.5 Mechanical and environmental specifications

- **Dimensions:** ETX form-factor, 114 mm x 95 mm (4.5" x 3.74")
- **Power supply voltage:** +5 V power only (+5VSB is optional for ACPI and ATX power)
- **Power requirement:**  
Max: +5V @ 2.58 A (D510 w/1GB DDR2 memory)
- **Operating temperature:** 0 ~ 60°C (32 ~ 140°F)
- **Operating humidity:** 0% ~ 90% relative humidity, non-condensing
- **Weight:** 0.103 Kg (weight of total package)



# Chapter 2

## Mechanical Information

This chapter gives mechanical and connector information on the SOM-4463 CPU System on Module.

Sections include:

- Connector Information
- Mechanical Drawing

## 2.1 Board Connectors

There are two connectors at the rear side of SOM-4463 for connecting to carrier board.

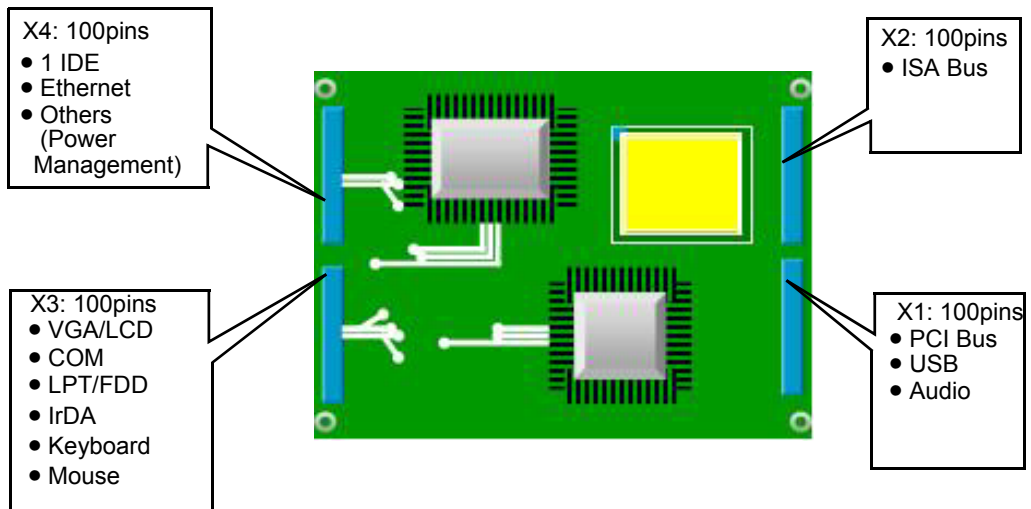

Figure 2.1 SOM-4463 Locating Connectors

### ■ Pin Assignments for X1/2/3/4 connectors

Please refer to SOM-ETX Design and Specification Guide. You can download it from:

[http://www.advantech.com/COM\\_Design\\_Support\\_Services/documentdownload.aspx](http://www.advantech.com/COM_Design_Support_Services/documentdownload.aspx)

## 2.2 Board Mechanical Drawing

### 2.2.1 Front Side

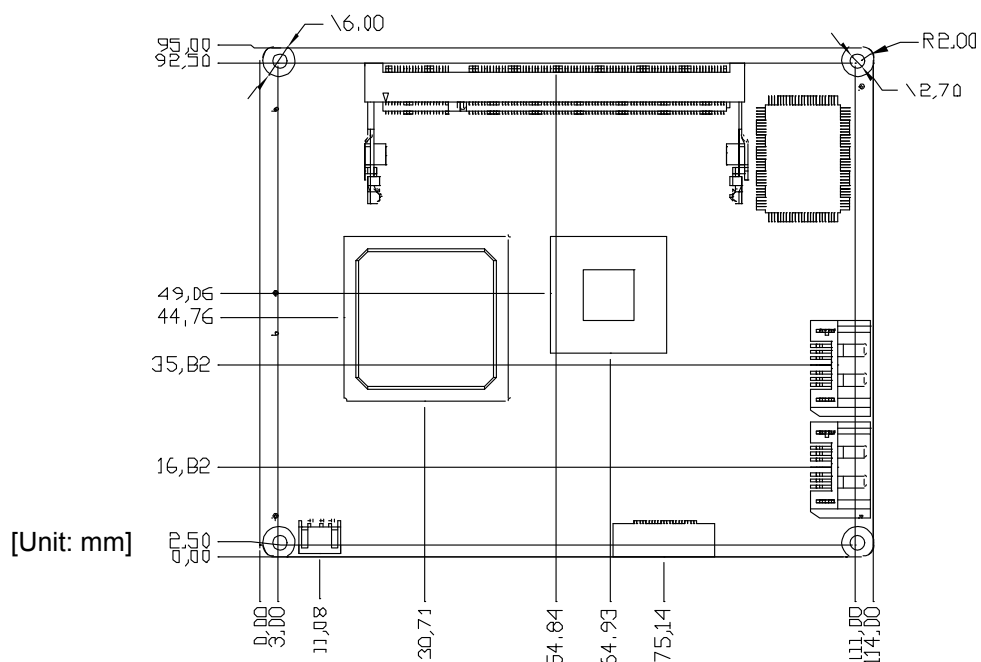

Figure 2.2 SOM-4463 Front Side Drawing

### 2.2.2 Rear Side

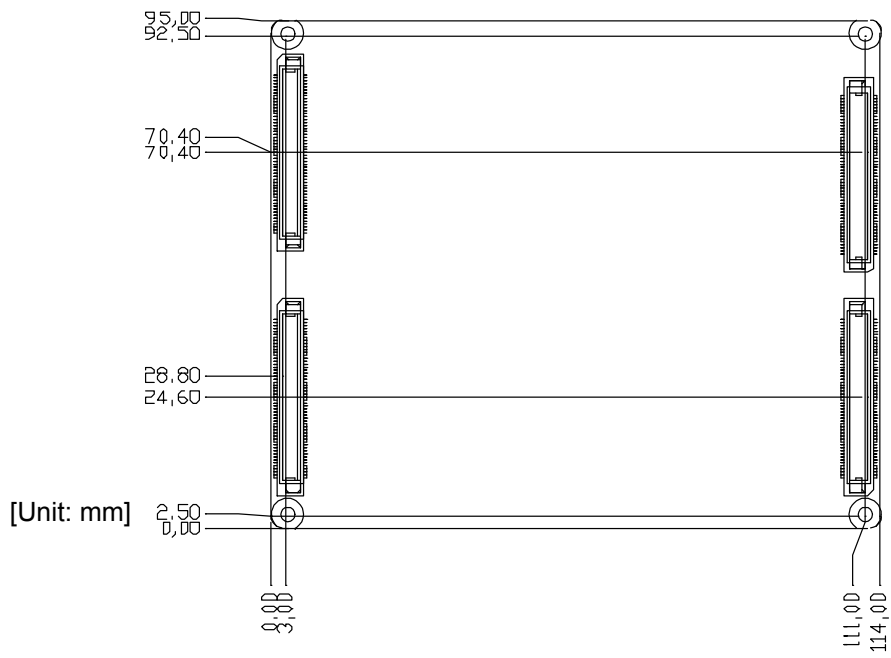

Figure 2.3 SOM-4463 Rear Side Drawing





# Chapter 3

## BIOS Setup Information

This chapter gives basic BIOS settings for SOM-4463 CPU System on Module.

Sections include:

- Main Setup
- Advanced Setup
- PCIPnP Setup
- Boot Setup
- Security Setup
- Chipset Setup

With the AMIBIOS Setup program, users can modify BIOS settings and control the various system features. This chapter describes the basic navigation of the SOM-4463 BIOS setup screens.

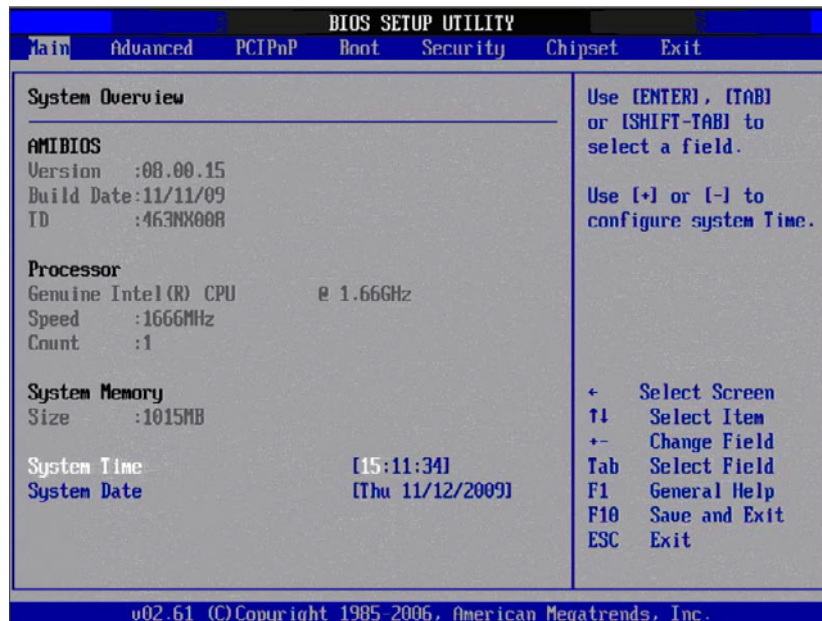

**Figure 3.1 Setup program initial screen**

AMI's BIOS ROM has a built-in Setup program that allows users to modify the basic system configuration. This information is stored in battery-backup CMOS so it retains the Setup information when the power is turned off.

## 3.1 Entering Setup

The BIOS is immediately activated when you first power on the computer. The BIOS reads the system information contained in the CMOS and begins the process of checking out the system and configuring it. When it finishes, the BIOS will seek an operating system on one of the disks and then launch and turn control over to that operating system. While the BIOS is in control, the Setup program can be activated in one of two ways:

1. By pressing <Del> immediately after switching the system on.
2. By pressing the <Del> key when the following message appears briefly at the bottom of the screen during the POST (Power On Self-Test). Press DEL to enter SETUP

If the message disappears before you respond and you still want to enter Setup, restart the system and try again by turning it OFF then ON again, or by pressing the Reset button on the system case. You may also restart by simultaneously pressing the Ctrl, Alt, and Delete keys.

## 3.2 Main Setup

When users first enter the BIOS Setup Utility, users will enter the Main setup screen. Users can always return to the Main setup screen by selecting the Main tab. There are two Main Setup options, which will be described in this section. The Main BIOS Setup screen is shown below.

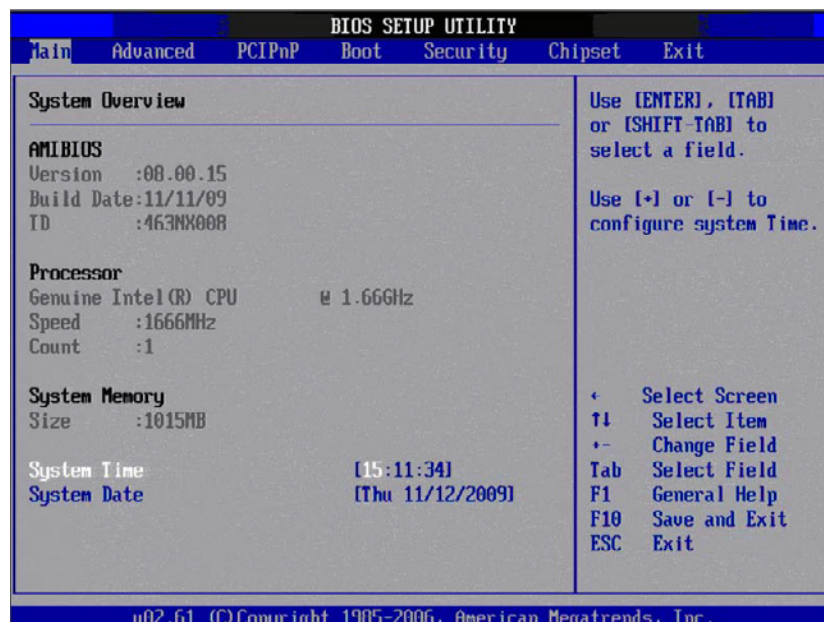

**Figure 3.2 Main setup screen**

The Main BIOS setup screen has two main frames. The left frame displays all the options that can be configured. Grayed-out options cannot be configured; options in blue can. The right frame displays the key legend.

Above the key legend is an area reserved for a text message. When an option is selected in the left frame, it is highlighted in white. Often a text message will accompany it.

### 3.2.1 System time / System date

Use this option to change the system time and date. Highlight System Time or System Date using the <Arrow> keys. Enter new values through the keyboard. Press the <Tab> key or the <Arrow> keys to move between fields. The date must be entered in MM/DD/YY format. The time must be entered in HH:MM:SS format.

## 3.3 Advanced BIOS Features Setup

Select the Advanced tab from the SOM-4463 setup screen to enter the Advanced BIOS Setup screen. Users can select any item in the left frame of the screen, such as CPU Configuration, to go to the sub menu for that item. Users can display an Advanced BIOS Setup option by highlighting it using the <Arrow> keys. All Advanced BIOS Setup options are described in this section. The Advanced BIOS Setup screens are shown below. The sub menus are described on the following pages.

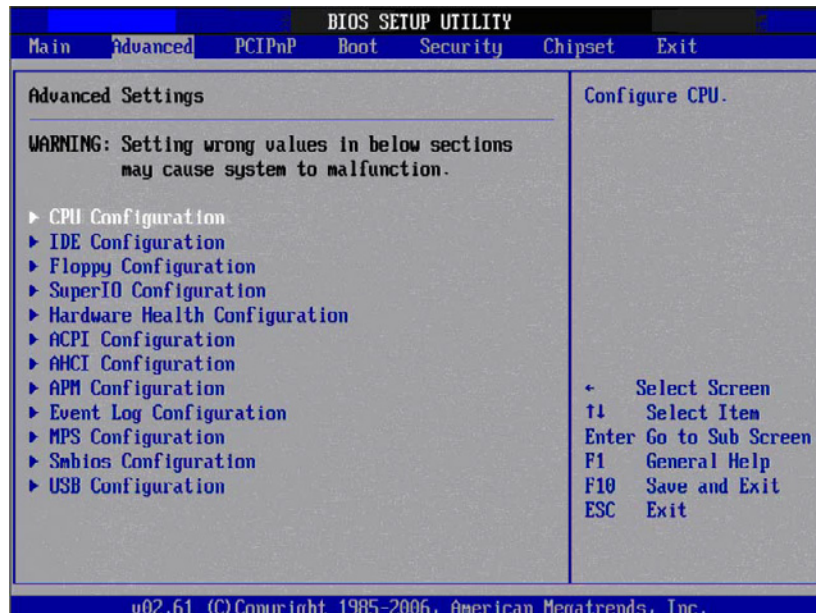

Figure 3.3 Advanced BIOS features setup screen

### 3.3.1 CPU Configuration

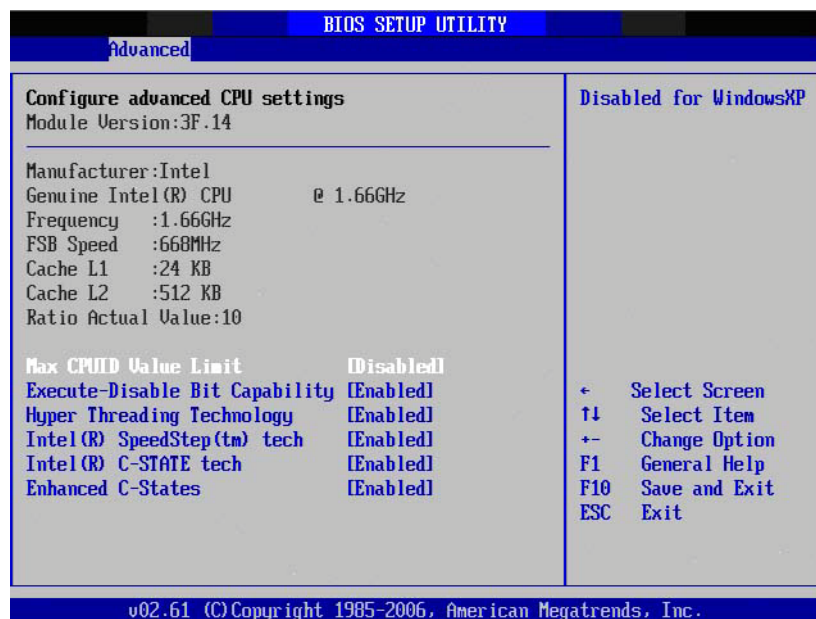

Figure 3.4 CPU Configuration Setting

- **Max CPUID Value Limit**  
This item allows users to limit the maximum value of CPUID.

- **Execute-Disable Bit Capability**  
This item allows users to enable or disable the No-Execution page protection technology.
- **Hyper Threading Technology**  
This item allows users to enable or disable Intel® Hyper Threading technology.
- **Intel® SpeedStep™ tech**  
CPU runs at its default speed if disabled; CPU speed is controlled by the operating system if enabled.
- **Intel® C-STATE tech**  
This item allows CPU to save more power in idle mode.
- **Enhanced C-States**  
Enable / Disable Intel® C-STATE technology.

### 3.3.2 IDE Configuration

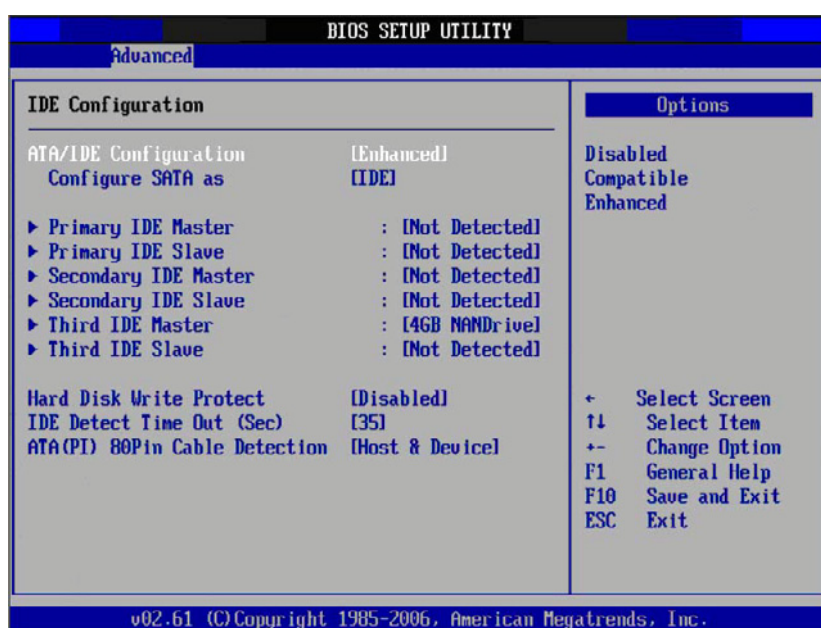

Figure 3.5 IDE Configuration

- **ATA/IDE Configuration**  
This item allows users to select Disabled / Compatible / Enhanced.
- **Legacy IDE Channels**  
When set to Enhanced mode, users can select IDE or AHCI mode. When select Compatible mode, users can select “SATA only”, “SATA Primary, PATA Secondary” or “PATA only”.
- **Primary/Secondary/Third IDE Master/Slave**  
BIOS auto detects the presence of IDE device, and displays the status of auto detection of IDE device.
  - Type: Select the type of SATA driver.[Not Installed][Auto][CD/DVD][ARMD]
  - LBA/Large Mode: Enables or Disables the LBA mode.
  - Block (Multi-Sector Transfer): Enables or disables data multi-sectors transfers.
  - PIO Mode: Select the operating mode of PIO.
  - DMA Mode: Select the operating mode of DMA
  - S.M.A.R.T.: Select the smart monitoring, analysis, and reporting technology.
  - 32-Bit Data Transfer: Enables or disables 32-bit data transfer.



- **Hard Disk Write Protect**  
Disable/Enable device write protection. This will be effective only if device is accessed through BIOS.
- **IDE Detect Time Out (Sec)**  
This item allows users to select the time out value for detecting ATA/ATAPI device(s).
- **ATA(P) 80Pin Cable Detection**  
This item allows users to select the way to detect IDE 80 pin cable.

### 3.3.3 Floppy Configuration

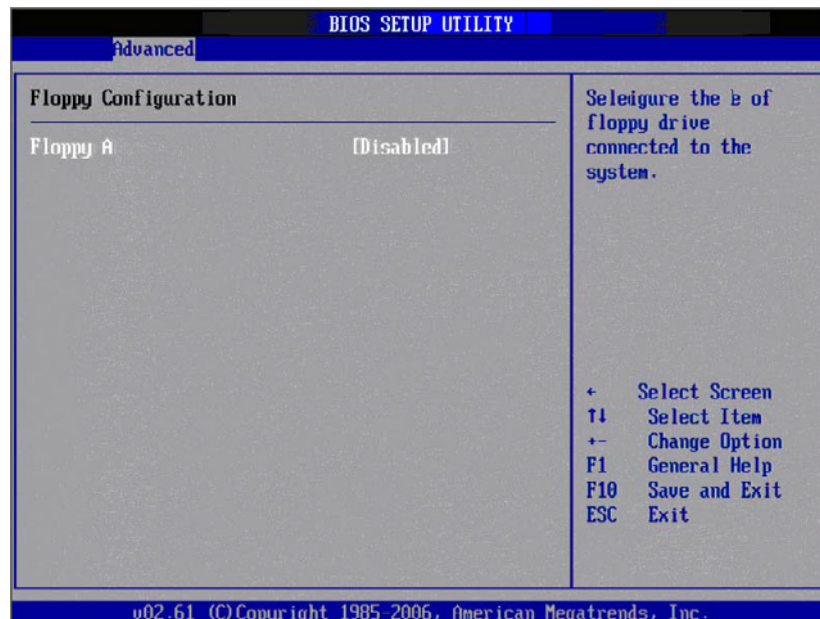

**Figure 3.6 Floppy Configuration**

- **Floppy A**  
Select the type of floppy drive, if any, connected to the system. Recommend to disable floppy driver during installing process of Windows Vista if no floppy drive connected.

### 3.3.4 Super I/O Configuration

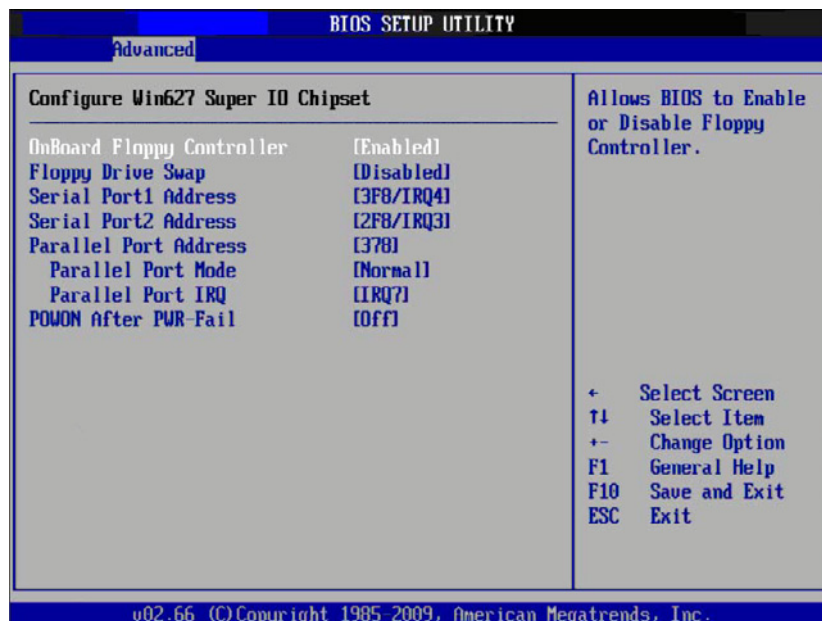

Figure 3.7 Super I/O Configuration

- **Onboard Floppy Controller**  
This item allows users to enable or disable onboard floppy controller.
- **Floppy Drive Swap**  
This item allows users to enable or disable floppy swap function.
- **Serial Port1 / Port2 address**  
This item allows users to select the base addresses and IRQs of serial port1 and port2.
- **Parallel Port Address**  
This item allows users to select the base address of parallel port.
- **Parallel Port Mode**  
This item allows users to select the mode of parallel port.
- **Parallel Port IRQ**  
This item allows users to select the IRQ of parallel port.
- **POWON After PWR-Fail**  
This item allows users to select off, on and former status.

### 3.3.5 Hardware Health Configuration

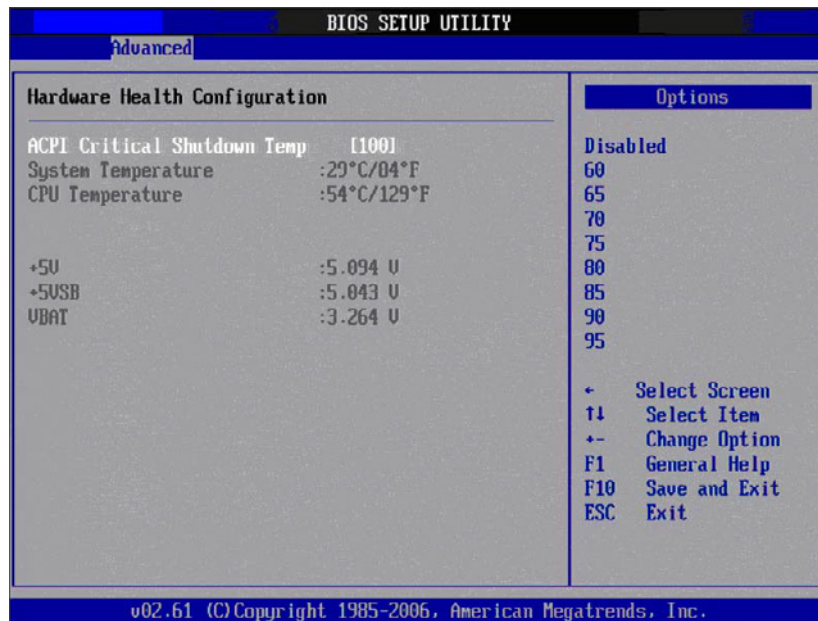

Figure 3.8 Hardware Health Configuration

- **ACPI Critical Shutdown Temp**  
This item allows you to set the CPU temperature to shutdown the system in ACPI OS.
- **Temperature & Voltage show**  
System/ CPU Temperature  
+5 V / +5 VSB / VBAT

### 3.3.6 ACPI Settings

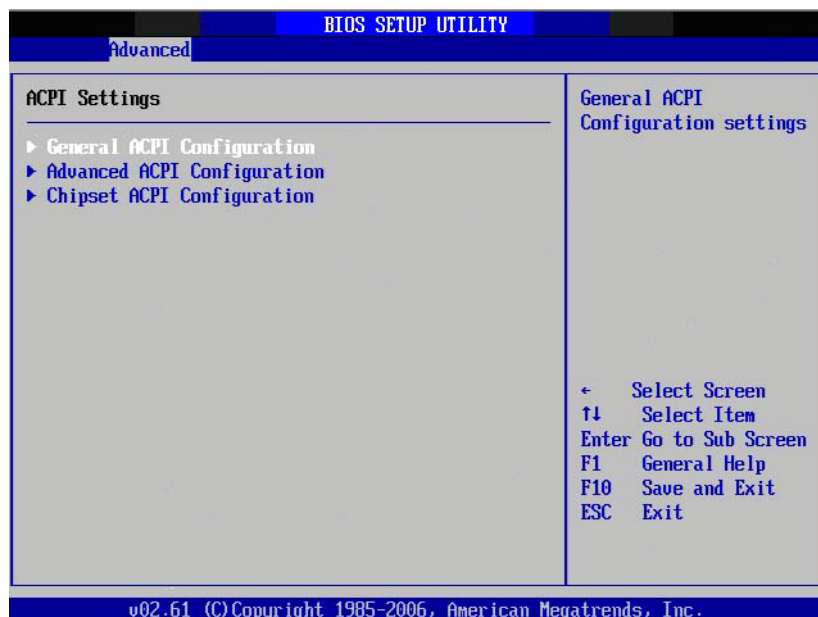

Figure 3.9 ACPI Settings



### 3.3.6.1 General ACPI Configuration

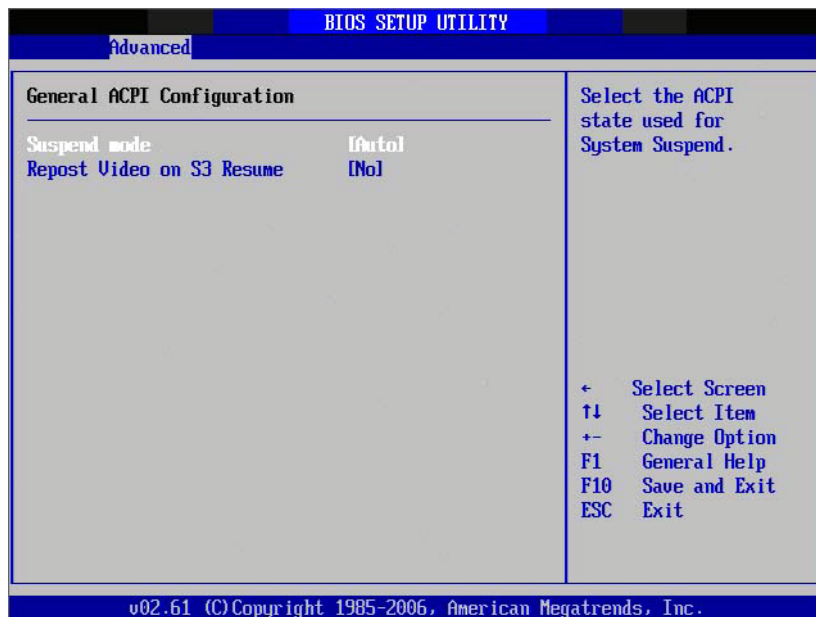

Figure 3.10 General ACPI Configuration

- **Suspend mode**  
Select the ACPI state used for system suspend.
- **Report Video on S3 Resume**  
This item allows users to invoke VGA BIOS POST on S3/STR resume.

### 3.3.6.2 Advanced ACPI Configuration

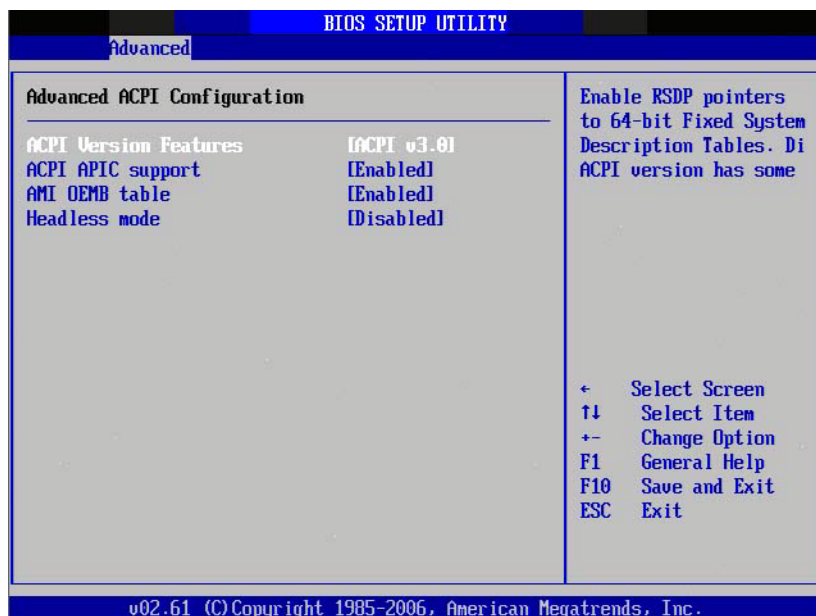
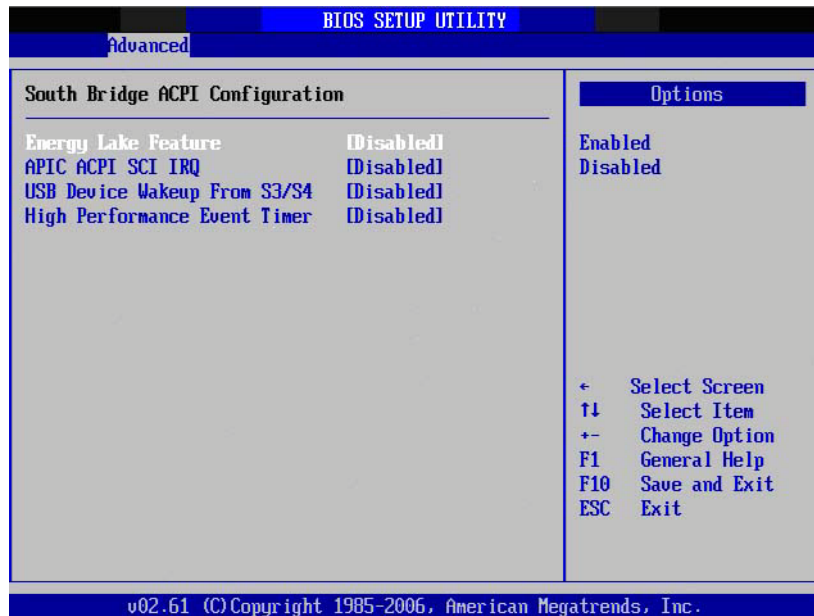

Figure 3.11 Advanced ACPI Configuration

- **ACPI Version Features**  
This item allows users to enable RSDP pointers to 64-bit fixed system description tables.
- **ACPI APIC support**  
Include APIC table pointer to RSDT pointer list.

- **AMI OEMB table**  
Include OEMB table pointer to R(x)SDT pointer lists.
- **Headless mode**  
Enable / Disable Headless operation mode through ACPI.

### 3.3.6.3 Chipset ACPI Configuration



**Figure 3.12 Chipset ACPI Configuration**

- **Energy Lake Feature**  
This item allows users to configure Intel Energy Lake power management technology.
- **APIC ACPI SCI IRQ**  
Enable/Disable APIC ACPI SCI IRQ.
- **USB Device Wakeup From S3/S4**  
Enable/Disable USB Device Wakeup from S3/S4.
- **High Performance Event Timer**  
Enable/Disable High performance Event timer.

### 3.3.7 AHCI Configuration

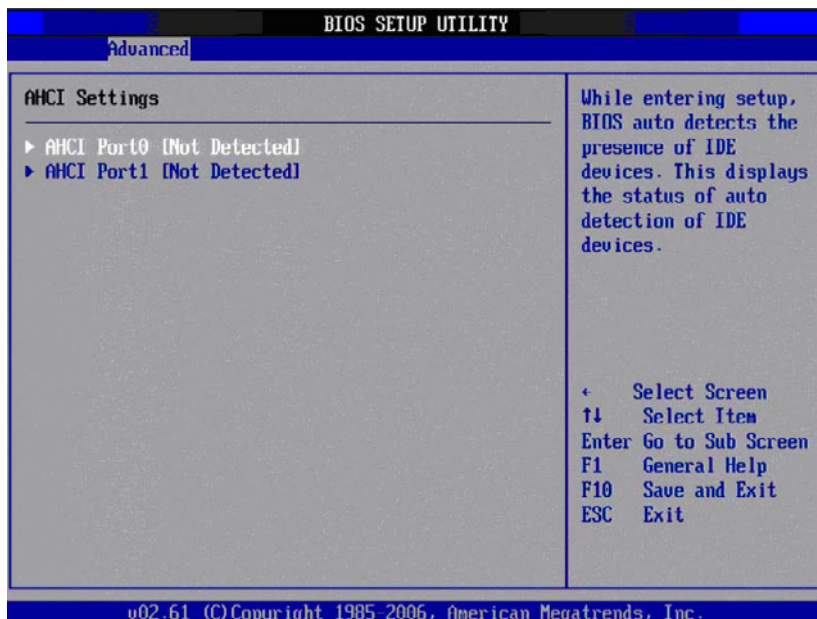

Figure 3.13 Advanced ACPI Configuration

- **AHCI Port0 / Port1**  
While entering setup, BIOS auto detects the presence of IDE devices and displays the status of auto detection of IDE device.

### 3.3.8 APM Configuration

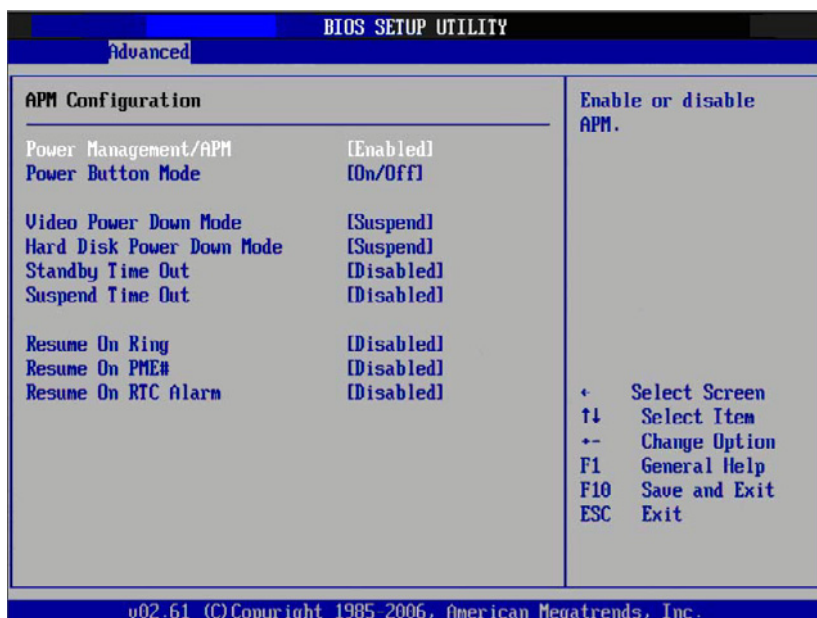

Figure 3.14 APM Configuration

- **Power Management/APM**  
Enable or disable APM.
- **Power Button Mode**  
Power on, off or enter suspend mode when the power button is pressed. The following options are also available.

- **Video Power Down Mode**  
Power down video in suspend or standby mode.
- **Hard Disk Power Down Mode**  
Power down Hard Disk in suspend or standby mode.
- **Standby Time Out**  
Go into Standby in the specified time.
- **Suspend Time Out**  
Go into Suspend in the specified time.
- **Resume On Ring**  
Enable / Disable RI to generate a wake event.
- **Resume On PME#**  
Enable / Disable PME to generate a wake event.
- **Resume On RTC Alarm**  
Enable / Disable RTC to generate a wake event.

### 3.3.9 Event Log Configuration



Figure 3.15 Event Log Configuration

- **View Event Log**  
View all unread events in the event Log.
- **Mark all events as read**  
Mark all unread events as read.
- **Clear Event Log**  
Discard all events in the event Log.

### 3.3.10 MPS Configuration

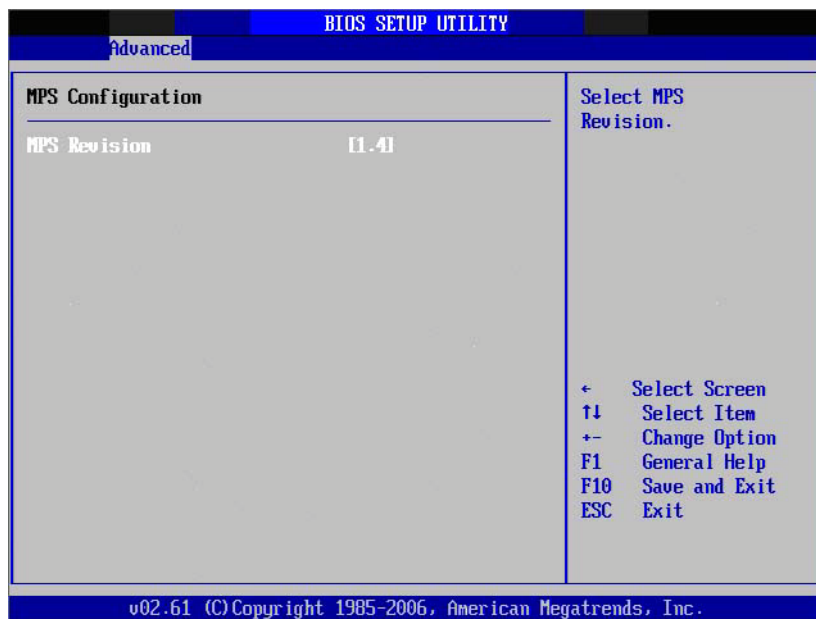

Figure 3.16 MPS Configuration

- **MPS Revision**  
This item allows users to select MPS reversion.

### 3.3.11 Smbios Configuration

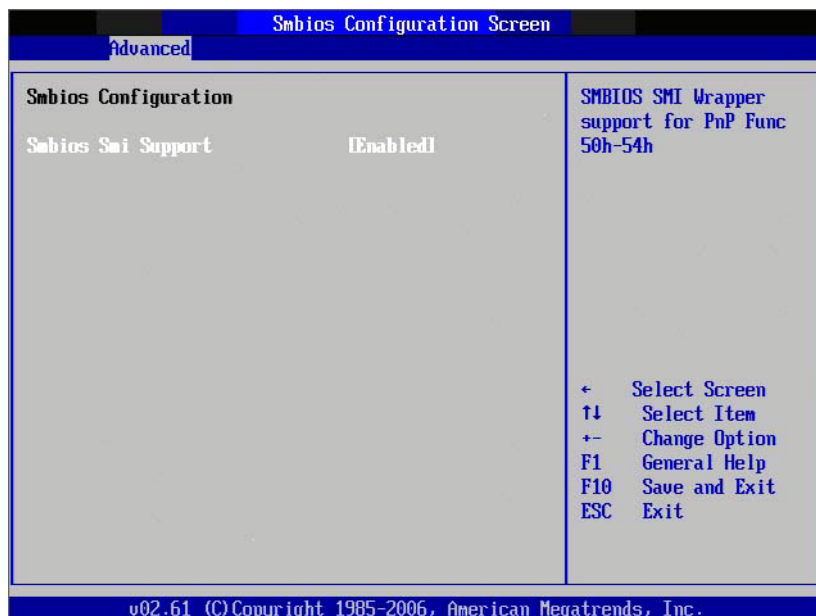

Figure 3.17 Smbios Configuration

- **Smbios Smi Support**  
SMBIOS SMI wrapper support for PnP function 50h-54h.

### 3.3.12 USB Configuration

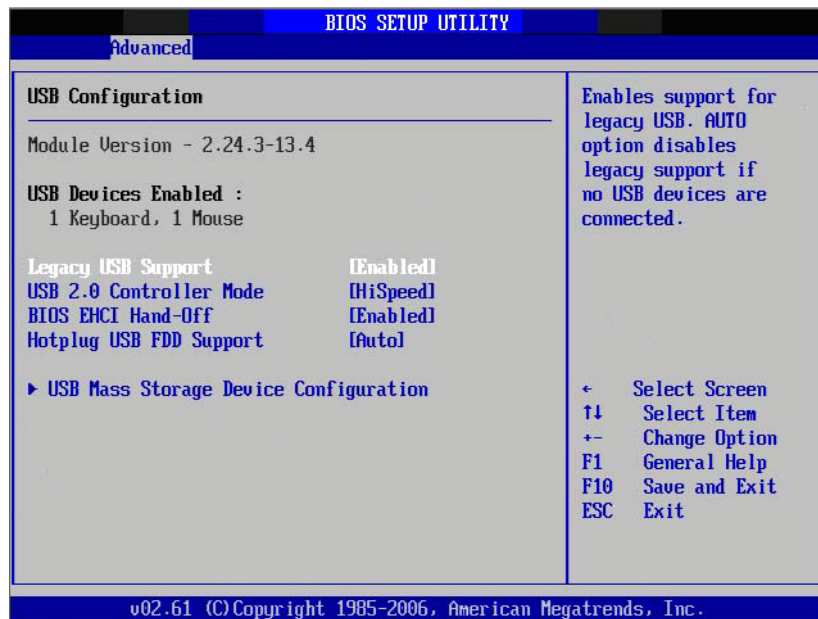

Figure 3.18 South Bridge ACPI Configuration

- **Legacy USB Support**  
Enable the support for legacy USB. Auto option disables legacy support if no USB devices are connected.
- **USB 2.0 Controller Mode**  
This item allows users to select HiSpeed (480Mbps) or FullSpeed (12Mbps).
- **BIOS EHCI Hand-Off**  
This is a workaround for the OS without EHCI hand-off support. The EHCI ownership change should claim by EHCI driver.
- **Hotplug USB FDD Support**  
A dummy FDD device is created that will be associated with the hot-plugged FDD later. Auto option creates this dummy device only if there is no USB FDD present.

### 3.3.13 USB Mass Storage Device Configuration

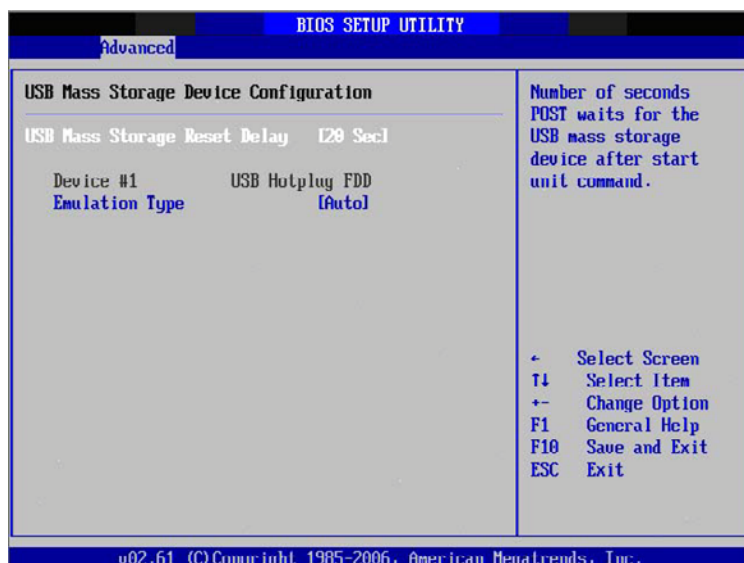

Figure 3.19 USB Mass storage Device Configuration

- **USB Mass Storage Reset Delay**  
Number of seconds POST waits for the USB mass storage device after start unit command.
- **Emulation Type**  
If Auto, USB devices less than 530MB will be emulated as Floppy and remaining as hard drive. Force FDD option can be used to force a FDD formatted drive to boot as FDD ( Ex. ZIP drive).

## 3.4 Advanced PCI/PnP Settings

Select the PCI/PnP tab from the SOM-4463 setup screen to enter the Plug and Play BIOS Setup screen. Users can display a Plug and Play BIOS Setup option by highlighting it using the <Arrow> keys. All Plug and Play BIOS Setup options are described in this section. The Plug and Play BIOS Setup screen is shown below.



Figure 3.20 PCI/PNP Setup



- **Clear NVRAM**  
Set this value to force the BIOS to clear the Non-Volatile Random Access Memory (NVRAM).The Optimal and Fail-Safe default setting is No.
- **Plug & Play O/S**  
When set to No, BIOS configures all devices in the system. When set to Yes and if users install a Plug and Play operating system, the operating system configures the Plug and Play devices not required for boot.
- **PCI Latency Timer**  
Value in units of PCI clocks for PCI device latency timer register.
- **Allocate IRQ to PCI VGA**  
When set to Yes will assigns IRQ to PCI VGA card if card requests IRQ. When set to No will not assign IRQ to PCI VGA card even if card requests an IRQ.
- **Palette Snooping**  
This item is designed to solve problems caused by some non-standard VGA card.
- **PCI IDE BusMaster**  
When set to enable BIOS, it uses PCI bus mastering for reading/writing to IDE drives.
- **OffBoard PCI/ISA IDE Card**  
Some PCI IDE cards may require this to be set to the PCI slot number that is holding the card. When set to Auto, it will works for most PCI IDE cards.
- **IRQ3 / 4 / 5 / 7 / 9 / 10 / 11**  
This item allows users respectively assign an interruptive type for IRQ-3, 4, 5, 7, 9, 10, 11.
- **DMA Channel0 / 1 / 3 / 5 / 6 / 7**  
When set to Available will specified DMA is available to be used by PCI/PnP devices. When set to Reserved will specified DMA will Reserved for use by legacy ISA devices.
- **Reserved Memory Size**  
This item allows users to reserved size of memory block for legacy ISA device.

## 3.5 Boot Settings



Figure 3.21 Boot Setup Utility



### 3.5.1 Boot settings Configuration

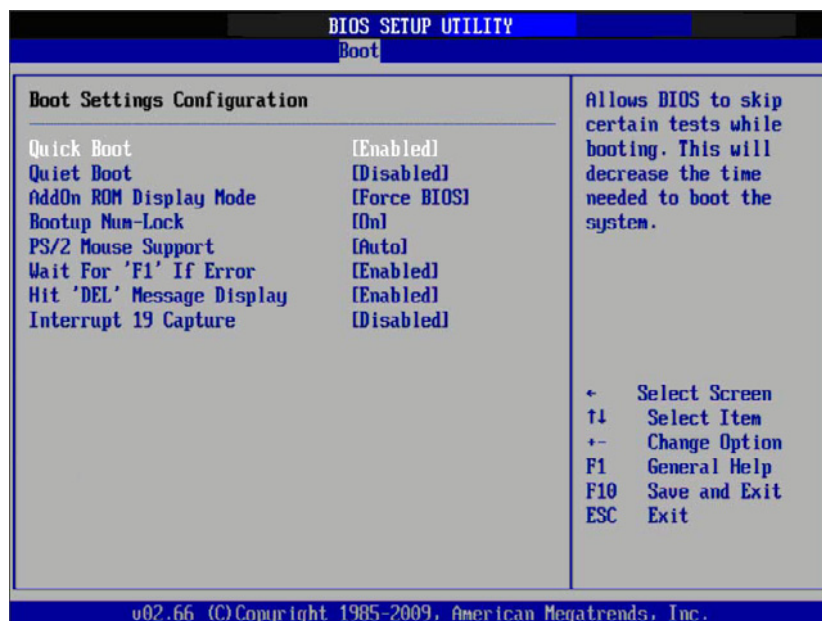

Figure 3.22 Boot Setting Configuration

- **Quick Boot**  
This item allows BIOS to skip certain tests while booting. This will decrease the time needed to boot the system.
- **Quiet Boot**  
If this option is set to Disabled, the BIOS displays normal POST messages. If Enabled, an OEM Logo is shown instead of POST messages.
- **AddOn ROM Display Mode**  
Set display mode for option ROM.
- **Bootup Num-Lock**  
Select the Power-on state for Numlock.
- **PS/2 Mouse Support**  
Select support for PS/2 Mouse.
- **Wait For "F1" If Error**  
Wait for the F1 key to be pressed if an error occurs.
- **Hit "DEL" Message Display**  
Displays - Press DEL to run Setup in POST.
- **Interrupt 19 Capture**  
This item allows option ROMs to trap interrupt 19.

## 3.6 Security Setup



**Figure 3.23 Password Configuration**

Select Security Setup from the SOM-4463 Setup main BIOS setup menu. All Security Setup options, such as password protection and virus protection are described in this section. To access the sub menu for the following items, select the item and press <Enter>:

- **Change Supervisor / User Password**  
Select this option and press <ENTER> to access the sub menu, and then type in the password.
- **Boot sector Virus protection**  
The boot sector virus protection will warn if any program tries to write to the boot sector.

## 3.7 Advanced Chipset Settings



Figure 3.24 Advanced Chipset Settings

### 3.7.1 North Bridge Chipset Configuration



Figure 3.25 North Bridge Configuration

- **DRAM Frequency**  
This item allows users to change DRAM frequency manually.
- **Configure DRAM Timing by SPD**  
This item allows users to enable or disable detection by DRAM SPD.
- **Memory Hole**  
This item allows users to free 15MB-16MB of memory size for some ISA devices.

- **Initate Graphic Adapter**  
This item allows users to select which graphics controller to use as the primary boot device.
- **Internal Graphics Mode Select**  
Select the amount of system memory can be used by the Internal graphics device.

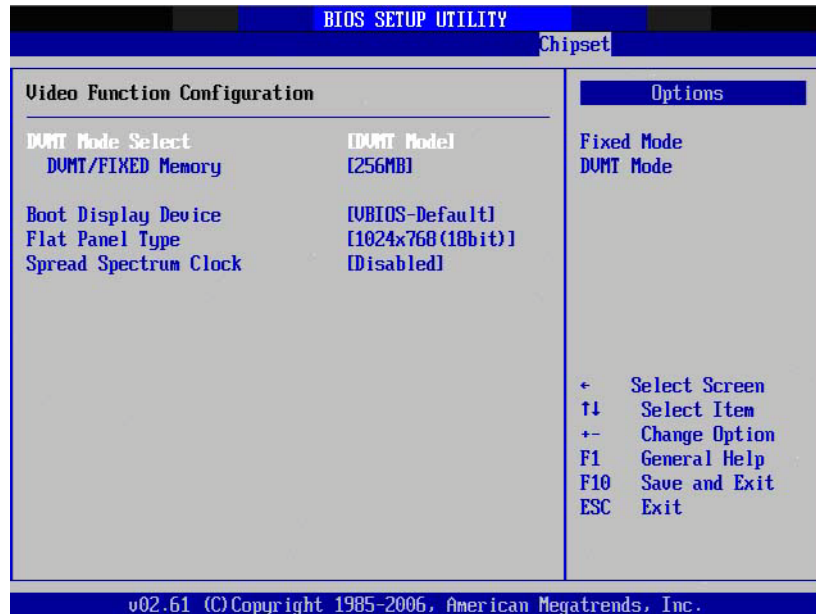

**Figure 3.26 Video Function Configuration**

- **DVMT Mode Select**  
Displays the active system memory mode.
- **DVMT/FIXED Memory**  
Specify the amount of DVMT / FIXED system memory to allocate for video memory.
- **Boot Display Device**  
Select boot display device at post stage.
- **Flat Panel Type**  
This item allows users to select panel resolution.
- **Spread Spectrum Clock**  
This item allows users to enable or disable spread spectrum clock.

## 3.7.2 South Bridge Chipset Configuration



Figure 3.27 South Bridge Configuration

- **USB Functions**  
Disabled, 2 USB Ports, 4 USB Ports.
- **USB 2.0 Controller**  
Enables or disables the USB 2.0 controller.
- **HDA Controller**  
Enables or disables the HDA controller.
- **SMBUS Controller**  
Enables or disables the SMBUS controller.
- **SLP\_S4# Min. Assertion Width**  
This item allows users to set a delay of sorts.

## 3.8 Exit Option

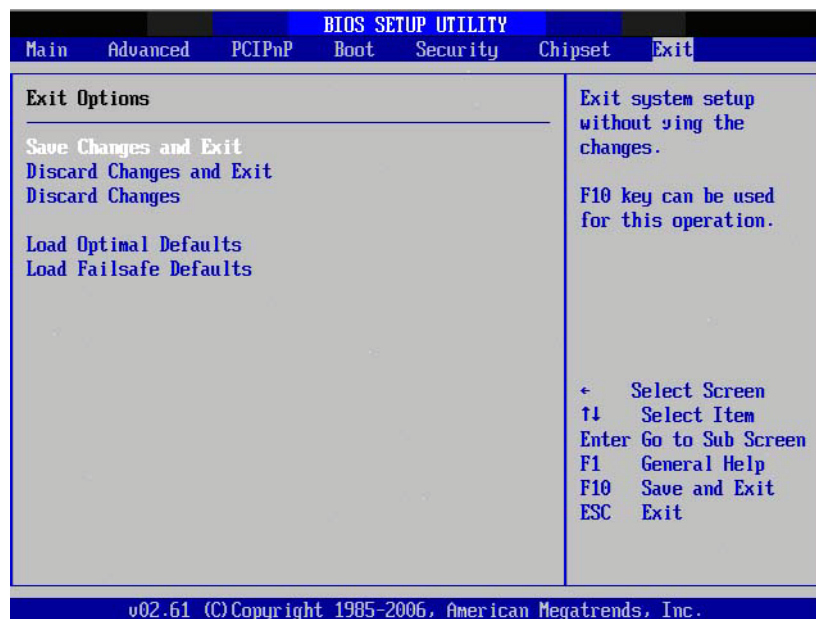

Figure 3.28 Exit Option

### 3.8.1 Save Changes and Exit

When users have completed system configuration, select this option to save changes, exit BIOS setup menu and reboot the computer to take effect all system configuration parameters.

1. Select Exit Saving Changes from the Exit menu and press <Enter>. The following message appears: Save Configuration Changes and Exit Now? [Ok] [Cancel]
2. Select Ok or cancel.

### 3.8.2 Discard Changes and Exit

Select this option to quit Setup without making any permanent changes to the system configuration.

1. Select Exit Discarding Changes from the Exit menu and press <Enter>. The following message appears: Discard Changes and Exit Setup Now? [Ok] [Cancel]
2. Select Ok to discard changes and exit. Discard Changes
3. Select Discard Changes from the Exit menu and press <Enter>.

### 3.8.3 Load Optimal Defaults

The SOM-4463 automatically configures all setup items to optimal settings when users select this option. Optimal Defaults are designed for maximum system performance, but may not work best for all computer applications. In particular, do not use the Optimal Defaults if user's computer is experiencing system configuration problems. Select Load Optimal Defaults from the Exit menu and press <Enter>.

### 3.8.4 Load Fail-Safe Defaults

The SOM-4463 automatically configures all setup options to fail-safe settings when users select this option. Fail-Safe Defaults are designed for maximum system stability, but not maximum performance. Select Fail-Safe Defaults if the user is experiencing system configuration problems.

- 1 Select Load Fail-Safe Defaults from the Exit menu and press <Enter>. The following message appears: Load Fail-Safe Defaults? [OK] [Cancel]
- 2 Select OK to load Fail-Safe defaults.





# Chapter 4

## Driver Installation

This chapter provides driver installation information for the SOM-4463 CPU System on Module.

Sections include:

- Driver Introduction
- Driver Installation

## 4.1 Driver Introduction and Installation

Product drivers for various OS are provided and can be updated from the website link shown below. Please follow the sequence below to complete the driver installation.

<http://support.advantech.com.tw>

**Step 1- Install Intel INF Update Driver**

**Step 2- Install Intel Graphic Driver**

**Step 3- Install Audio Driver**

**Step 4- Install Intel Ethernet Driver**

**Step 5- Install IT8888 PCI to ISA Driver**

**Note!** For Windows XP Embedded, Windows CE 5.0 and Linux support, please contact a sales representative or technical person.



**Note!** Downloading the update for Windows XP may be required for enabling USB 2.0 function. Please refer to below web link for detail information.



<http://www.microsoft.com/whdc/system/bus/USB/USB2support.mspx>

The image shows a CD-ROM on the left and a screenshot of the Advantech website on the right. An arrow points from the CD-ROM to the website. The CD-ROM is labeled "Drivers & Manuals for Embedded Computing Platform" and "Embedded Computing Group". The website screenshot shows the "Support & Download" section with a navigation menu on the left and a main content area featuring "AdvantechCare Extended Warranty Service" and a "Keyword Search" box.

5.

# Appendix **A**

## Watchdog Timer

This appendix gives you the information about the watchdog timer programming on the SOM-4463 CPU System on Module.

Sections include:

- Programming the Watchdog Timer

## A.1 Programming the Watchdog Timer

The sample code of programming the Watchdog Timer function:

-----  
Enter the extended function mode, interruptible double-write

```
MOV DX,2EH
MOV AL,87H
OUT DX,AL
OUT DX,AL
```

-----  
Configured logical device 8, configuration register CRF6

```
MOV DX,2EH
MOV AL,2BH
OUT DX,AL
MOV DX,2FH
IN AL,DX
AND AL,OEF;Setbit 4=0 Pin 89=WDTO
OUT DX,AL
MOV DX,2EH
MOV AL,07H; point to Logical Device Number Reg.
OUT DX,AL
MOV DX,2FH
MOV AL,08H; select logical device 8
OUT DX,AL;
MOV DX,2EH
MOV AL,30H;Set watch dog activate or inactivate
OUT DX,AL
MOV DX,2FH
MOV AL,01H; 01:activate 00:inactivate
OUT DX,AL;
MOV DX,2EH
MOV AL,F5H; Setting counter unit is second
OUT DX,AL
MOV DX,2FH
MOV AL,00H
OUT DX,AL;
MOV DX,2EH
MOV AL,F6H
OUT DX,AL
MOV DX,2FH
MOV AL,05H; Set 5 seconds
OUT DX,AL
```

;-----

; Exit extended function mode |

;-----

MOV DX,2EH

MOV AL,AAH

OUT DX,AL



# Appendix **B**

## System Assignments

This appendix gives you the information about the system resource allocation on the SOM-4463 CPU System on Module.

Sections include:

- System I/O ports
- DMA Channel Assignments
- Interrupt Assignments
- System Memory Map

## B.1 System I/O Ports

**Table B.1: System I/O ports**

<b>I/O Address (Hex)</b>	
0000 - 000F	Direct memory access controller
0000 - 0CF7	PCI bus
0010 - 001F	Motherboard resources
0020 - 0021	Programmable interrupt controller
0022 - 003F	Motherboard resources
0040 - 0043	System timer
0044 - 005F	Motherboard resources
0060 - 0060	Standard 101/102-Key or Microsoft Natural PS/2 Keyboard
0061 - 0061	System speaker
0062 - 0063	Motherboard resources
0064 - 0064	Standard 101/102-Key or Microsoft Natural PS/2 Keyboard
0065 - 006F	Motherboard resources
0070 - 0071	System CMOS/real time clock
0072 - 007F	Motherboard resources
0080 - 0080	Motherboard resources
0081 - 0083	Direct memory access controller
0084 - 0086	Motherboard resources
0087 - 0087	Direct memory access controller
0088 - 0088	Motherboard resources
0089 - 008B	Direct memory access controller
008C - 008E	Motherboard resources
008F - 008F	Direct memory access controller
0090 - 009F	Motherboard resources
00A0 - 00A1	Programmable interrupt controller
00A2 - 00BF	Motherboard resources
00C0 - 00DF	Direct memory access controller
00E0 - 00EF	Motherboard resources
00F0 - 00FF	Numeric data processor
01F0 - 01F7	Primary IDE Channel
0274 - 0277	ISAPNP Read Data Port
0279 - 0279	ISAPNP Read Data Port
0280 - 028F	Motherboard resources
0290 - 029F	Motherboard resources
02F8 - 02FF	Communications Port (COM2)
0378 - 037F	Printer Port (LPT1)
03B0 - 03BB	Intel(R) Graphic Media Accelerator 3150
03C0 - 03DF	Intel(R) Graphic Media Accelerator 3150
03F6 - 03F6	Primary IDE Channel
03F8 - 03FF	Communications Port (COM1)
0400 - 041F	Intel(R) ICH8 Family SMBus Controller - 283E
04D0 - 04D1	Motherboard resources
0500 - 053F	Motherboard resources
0800 - 087F	Motherboard resources



**Table B.1: System I/O ports**

0A00 - 0A0F	Motherboard resources
0A79 - 0A79	ISAPNP Read Data Port
0D00 - FFFF	PCI bus
C800 - C807	Intel(R) Graphic Media Accelerator 3150
C880 - C89F	Intel ICH8 Family USB Universal Host Controller - 2831
CC00 - CC1F	Intel ICH8 Family USB Universal Host Controller - 2830
D080 - D08F	Intel ICH8M 3 port Serial ATA Storage Controller - 2828
D400 - D40F	Intel ICH8M 3 port Serial ATA Storage Controller - 2828
D480 - D483	Intel ICH8M 3 port Serial ATA Storage Controller - 2828
D800 - D807	Intel ICH8M 3 port Serial ATA Storage Controller - 2828
D880 - D883	Intel ICH8M 3 port Serial ATA Storage Controller - 2828
DC00 - DC07	Intel ICH8M 3 port Serial ATA Storage Controller - 2828
EO00 - EFFF	Intel(R) ICH8 Family PCI-E Root Port5 - 2847
E800 - E8FF	Realtek PCIe FE Family Controller
FFA0 - FFAF	Intel ICH8M Ultra ATA Storage Controller - 2850

## B.2 DMA Channel Assignments

**Table B.2: DMA channel assignments**

Channel	Function
0	Available
1	Available
2	Available
3	Available
4	Direct memory access controller
5	Available
6	Available
7	Available

## B.3 Interrupt Assignments

**Table B.3: Interrupt assignments**

Interrupt#	Interrupt source
IRQ 0	System timer
IRQ 1	Standard 101/102-Key or Microsoft Natural PS/2 Keyboard
IRQ 2	Available
IRQ 3	Communications Port (COM2)
IRQ 4	Communications Port (COM1)
IRQ 5	Available
IRQ 6	Available
IRQ 7	Available
IRQ 8	System CMOS/real time clock
IRQ 9	Microsoft ACPI-Compliant System
IRQ 10	Intel ICH8 Family SMBus Controller - 283E

**Table B.3: Interrupt assignments**

IRQ 11	Available
IRQ 12	PS/2 Compatible Mouse
IRQ 13	Numeric data processor
IRQ 14	Primary IDE Channel
IRQ 15	Available
IRQ 16	Intel(R) Graphic Media Accelerator 3150
IRQ 16	Realtek PCIe FE Family Controller
IRQ 18	Intel(R) ICH8M 3 port Serial ATA Host Contrller - 2828
IRQ 19	Intel(R) ICH8 Family USB Universal Host Contrller - 2831*
IRQ 21	Microsoft UAA Bus Driver for High Definition Audio
IRQ 22	Intel(R) ICH8 Family PCI-E Root Port1 - 283F
IRQ 22	Intel(R) ICH8 Family PCI-E Root Port5 - 2847
IRQ 23	Intel ICH8 Family USB Universal Host Contrller - 2830*
IRQ 23	Intel ICH8 Family USB Universal Host Contrller - 2836*

\*USB and Ethernet IRQ is automatically set by the system.

## B.4 System Memory Map

**Table B.4: System Memory Map**

Addr. range (Hex)	Device
00000000 - 0009FFFF	System board
000A0000 - 000BFFFF	Intel(R) Graphic Media Accelerator 3150
000A0000 - 000BFFFF	PCI Bus
000C0000 - 000CFFFF	System board
000D0000 - 000DFFFF	PCI bus
000E0000 - 000FFFFF	System board
00100000 - 3F6FFFFF	System board
3F700000 - DFFFFFFF	PCI Bus
D0000000 - DFFFFFFF	Intel(R) Graphic Media Accelerator 3150
E0000000 - EFFFFFFF	Motherboard resource
F0000000 - FED8FFFF	PCI Bus
FDF00000 - FDFFFFFF	Intel(R) ICH8 Family PCI-E Root Port5 - 2847
FDF00000 - FDFFFFFF	Realtek PCIe FE Family Controller
FE880000 - FE8FFFFF	Intel(R) Graphic Media Accelerator 3150
FE900000 - FE9FFFFF	Intel(R) Graphic Media Accelerator 3150
FEAC0000 - FEA7FFFF	Intel(R) Graphic Media Accelerator 3150
FEAF8000 - FEAFBFFF	Microsoft UAA Bus Driver for High Definition Audio
FEAFF800 - FEAFBFFF	Intel ICH8 Family USB2 Enhanced Host Controller - 2836
FEAFFC00 - FEAFFCFF	Intel ICH8 Family SMBus Controller - 283E
FEB00000 - FEBFFFFF	Intel(R) ICH8 Family PCI-E Root Port5 - 2847
FEBFF000 - FEBFFFFF	Realtek PCIe FE Family Controller
FEC00000 - FEC00FFF	Motherboard resources
FED14000 - FED19FFF	System board
FED1C000 - FED1FFFF	Motherboard resources
FED20000 - FED3FFFF	Motherboard resources

**Table B.4: System Memory Map**

FED40000 - FED8FFFF	Motherboard resources
FED90000 - FED93FFF	System board
FED90000 - FFFFFFFF	System board
FEE00000 - FEE00FFF	Motherboard resources

**ADVANTECH**

*Enabling an Intelligent Planet*

**[www.advantech.com](http://www.advantech.com)**

Please verify specifications before quoting. This guide is intended for reference purposes only.

All product specifications are subject to change without notice.

No part of this publication may be reproduced in any form or by any means, electronic, photocopying, recording or otherwise, without prior written permission from the publisher.

All brand and product names are trademarks or registered trademarks of their respective companies.

© Advantech Co., Ltd. 2014