

## IMPORTANT NOTICE

Dear customer,

As of December 7th, 2015 BL RF Power of NXP Semiconductors will operate as an independent company under the new trade name Ampleon, which will be used in future data sheets together with new contact details.

In data sheets, where the previous Philips references is mentioned, please use the new links as shown below.

<http://www.philips.semiconductors.com> use <http://www.ampleon.com>

<http://www.semiconductors.philips.com> use <http://www.ampleon.com> (Internet)

[sales.addresses@www.semiconductors.philips.com](mailto:sales.addresses@www.semiconductors.philips.com) use  
<http://www.ampleon.com/sales>

The copyright notice at the bottom of each page (or elsewhere in the document, depending on the version)

- © Koninklijke Philips Electronics N.V. (year). All rights reserved -  
is replaced with:

- © Ampleon B.V. (year). All rights reserved. -

If you have any questions related to the data sheet, please contact our nearest sales office (details via <http://www.ampleon.com/sales>).

Thank you for your cooperation and understanding,

Ampleon

# VHF push-pull power MOS transistor

# BLF278

### FEATURES

- High power gain
- Easy power control
- Good thermal stability
- Gold metallization ensures excellent reliability.

### APPLICATIONS

- Broadcast transmitters in the VHF frequency range.

### DESCRIPTION

Dual push-pull silicon N-channel enhancement mode vertical D-MOS transistor encapsulated in a 4-lead, SOT262A1 balanced flange package with two ceramic caps. The mounting flange provides the common source connection for the transistors.

### PINNING - SOT262A1

| PIN | DESCRIPTION |
|-----|-------------|
| 1   | drain 1     |
| 2   | drain 2     |
| 3   | gate 1      |
| 4   | gate 2      |
| 5   | source      |

| CAUTION  |
|--|
| This product is supplied in anti-static packing to prevent damage caused by electrostatic discharge during transport and handling. For further information, refer to Philips specs.: SNW-EQ-608, SNW-FQ-302A, and SNW-FQ-302B. |

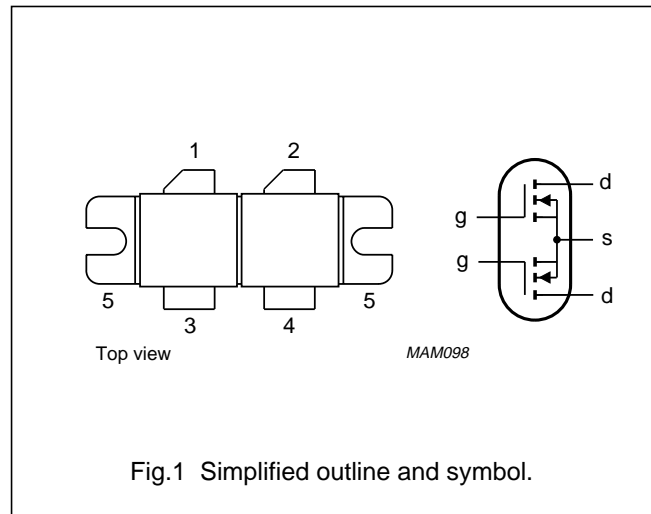

### QUICK REFERENCE DATA

RF performance at  $T_h = 25\text{ }^\circ\text{C}$  in a push-pull common source test circuit.

| MODE OF OPERATION | f (MHz) | V <sub>DS</sub> (V) | P <sub>L</sub> (W) | G <sub>p</sub> (dB) | $\eta_D$ (%)   |
|-------------------|---------|---------------------|--------------------|---------------------|----------------|
| CW, class-B       | 108     | 50                  | 300                | >20                 | >60            |
| CW, class-C       | 108     | 50                  | 300                | typ. 18             | typ. 80        |
| CW, class-AB      | 225     | 50                  | 250                | >14<br>typ. 16      | >50<br>typ. 55 |

| WARNING  |
|--|
| <b>Product and environmental safety - toxic materials</b>  |
| This product contains beryllium oxide. The product is entirely safe provided that the BeO discs are not damaged. All persons who handle, use or dispose of this product should be aware of its nature and of the necessary safety precautions. After use, dispose of as chemical or special waste according to the regulations applying at the location of the user. It must never be thrown out with the general or domestic waste. |

# VHF push-pull power MOS transistor

BLF278

## LIMITING VALUES

In accordance with the Absolute Maximum System (IEC 60134).

| SYMBOL                        | PARAMETER               | CONDITIONS  | MIN. | MAX.     | UNIT             |
|-------------------------------|-------------------------|---|------|----------|------------------|
| <b>Per transistor section</b> |                         |   |      |          |                  |
| $V_{DS}$                      | drain-source voltage    |   | –    | 125      | V                |
| $V_{GS}$                      | gate-source voltage     |   | –    | $\pm 20$ | V                |
| $I_D$                         | drain current (DC)      |   | –    | 18       | A                |
| $P_{tot}$                     | total power dissipation | $T_{mb} \leq 25\text{ }^\circ\text{C}$ ; total device; both sections equally loaded | –    | 500      | W                |
| $T_{stg}$                     | storage temperature     |   | –65  | 150      | $^\circ\text{C}$ |
| $T_j$                         | junction temperature    |   | –    | 200      | $^\circ\text{C}$ |

## THERMAL CHARACTERISTICS

| SYMBOL         | PARAMETER   | CONDITIONS                                  | VALUE     | UNIT |
|----------------|---|---|-----------|------|
| $R_{th\ j-mb}$ | thermal resistance from junction to mounting base | total device; both sections equally loaded. | max. 0.35 | K/W  |
| $R_{th\ mb-h}$ | thermal resistance from mounting base to heatsink | total device; both sections equally loaded. | max. 0.15 | K/W  |

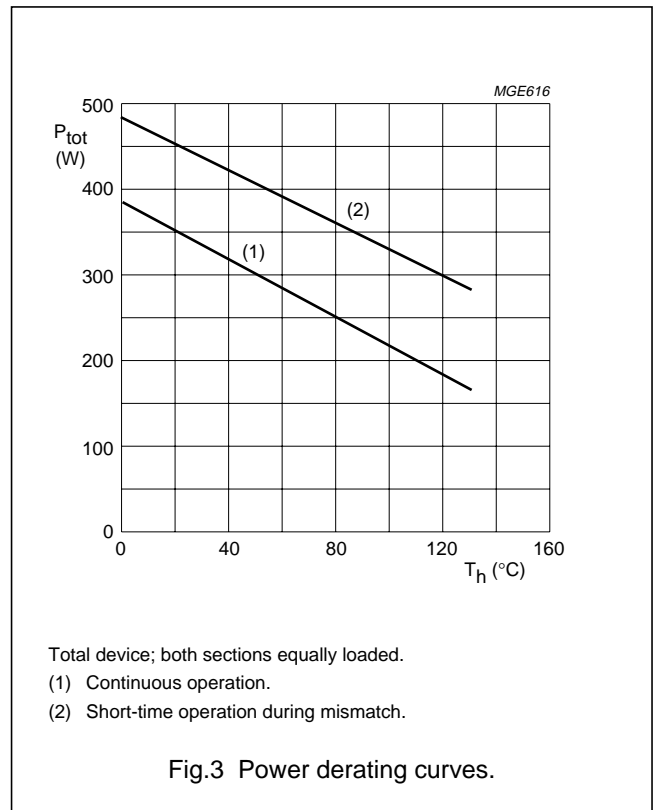
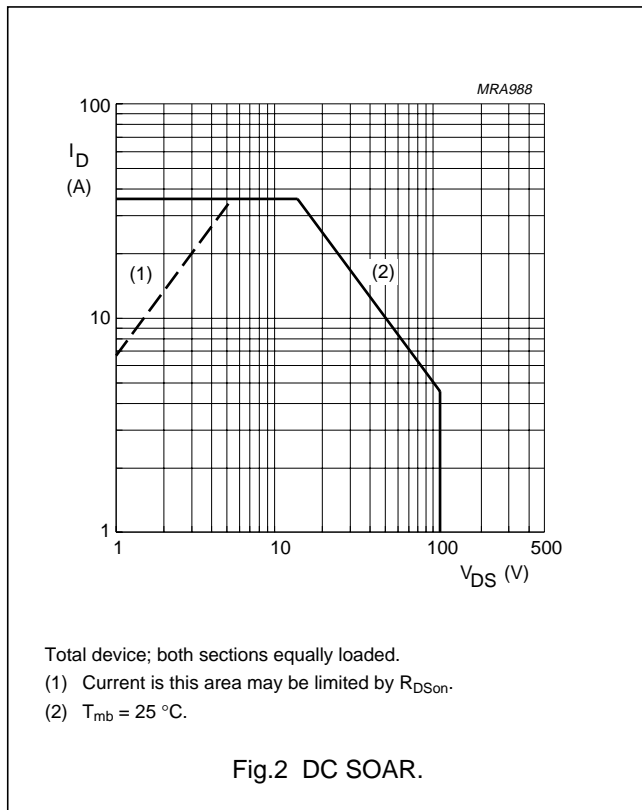

## VHF push-pull power MOS transistor

BLF278

## CHARACTERISTICS

 $T_j = 25\text{ }^\circ\text{C}$  unless otherwise specified.

| SYMBOL                        | PARAMETER                                       | CONDITIONS   | MIN. | TYP. | MAX. | UNIT          |
|-------------------------------|---|--|------|------|------|---------------|
| <b>Per transistor section</b> |   |  |      |      |      |               |
| $V_{(BR)DSS}$                 | drain-source breakdown voltage                  | $V_{GS} = 0$ ; $I_D = 100\text{ mA}$                       | 125  | –    | –    | V             |
| $I_{DSS}$                     | drain-source leakage current                    | $V_{GS} = 0$ ; $V_{DS} = 50\text{ V}$                      | –    | –    | 2.5  | mA            |
| $I_{GSS}$                     | gate-source leakage current                     | $V_{GS} = \pm 20\text{ V}$ ; $V_{DS} = 0$                  | –    | –    | 1    | $\mu\text{A}$ |
| $V_{GSth}$                    | gate-source threshold voltage                   | $V_{DS} = 10\text{ V}$ ; $I_D = 50\text{ mA}$              | 2    | –    | 4.5  | V             |
| $\Delta V_{GS}$               | gate-source voltage difference of both sections | $V_{DS} = 10\text{ V}$ ; $I_D = 50\text{ mA}$              | –    | –    | 100  | mV            |
| $g_{fs}$                      | forward transconductance                        | $V_{DS} = 10\text{ V}$ ; $I_D = 5\text{ A}$                | 4.5  | 6.2  | –    | S             |
| $g_{fs1}/g_{fs2}$             | forward transconductance ratio of both sections | $V_{DS} = 10\text{ V}$ ; $I_D = 5\text{ A}$                | 0.9  | –    | 1.1  |               |
| $R_{DSon}$                    | drain-source on-state resistance                | $V_{GS} = 10\text{ V}$ ; $I_D = 5\text{ A}$                | –    | 0.2  | 0.3  | $\Omega$      |
| $I_{DSX}$                     | drain cut-off current                           | $V_{GS} = 10\text{ V}$ ; $V_{DS} = 10\text{ V}$            | –    | 25   | –    | A             |
| $C_{is}$                      | input capacitance                               | $V_{GS} = 0$ ; $V_{DS} = 50\text{ V}$ ; $f = 1\text{ MHz}$ | –    | 480  | –    | pF            |
| $C_{os}$                      | output capacitance                              | $V_{GS} = 0$ ; $V_{DS} = 50\text{ V}$ ; $f = 1\text{ MHz}$ | –    | 190  | –    | pF            |
| $C_{rs}$                      | feedback capacitance                            | $V_{GS} = 0$ ; $V_{DS} = 50\text{ V}$ ; $f = 1\text{ MHz}$ | –    | 14   | –    | pF            |
| $C_{d-f}$                     | drain-flange capacitance                        |  | –    | 5.4  | –    | pF            |

 $V_{GS}$  group indicator

| GROUP | LIMITS (V) |      | GROUP | LIMITS (V) |      |
|-------|------------|------|-------|------------|------|
|       | MIN.       | MAX. |       | MIN.       | MAX. |
| A     | 2.0        | 2.1  | O     | 3.3        | 3.4  |
| B     | 2.1        | 2.2  | P     | 3.4        | 3.5  |
| C     | 2.2        | 2.3  | Q     | 3.5        | 3.6  |
| D     | 2.3        | 2.4  | R     | 3.6        | 3.7  |
| E     | 2.4        | 2.5  | S     | 3.7        | 3.8  |
| F     | 2.5        | 2.6  | T     | 3.8        | 3.9  |
| G     | 2.6        | 2.7  | U     | 3.9        | 4.0  |
| H     | 2.7        | 2.8  | V     | 4.0        | 4.1  |
| J     | 2.8        | 2.9  | W     | 4.1        | 4.2  |
| K     | 2.9        | 3.0  | X     | 4.2        | 4.3  |
| L     | 3.0        | 3.1  | Y     | 4.3        | 4.4  |
| M     | 3.1        | 3.2  | Z     | 4.4        | 4.5  |
| N     | 3.2        | 3.3  |       |            |      |

VHF push-pull power MOS transistor

BLF278

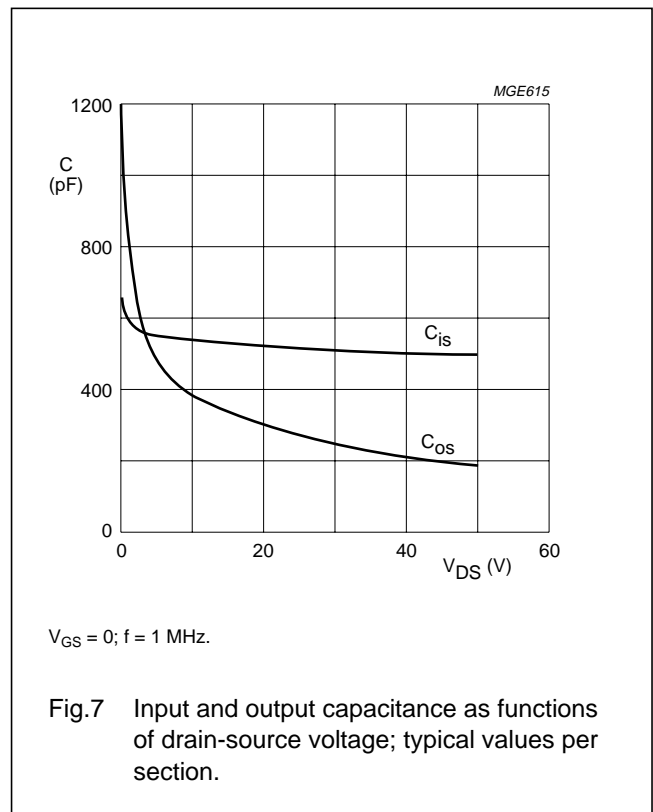
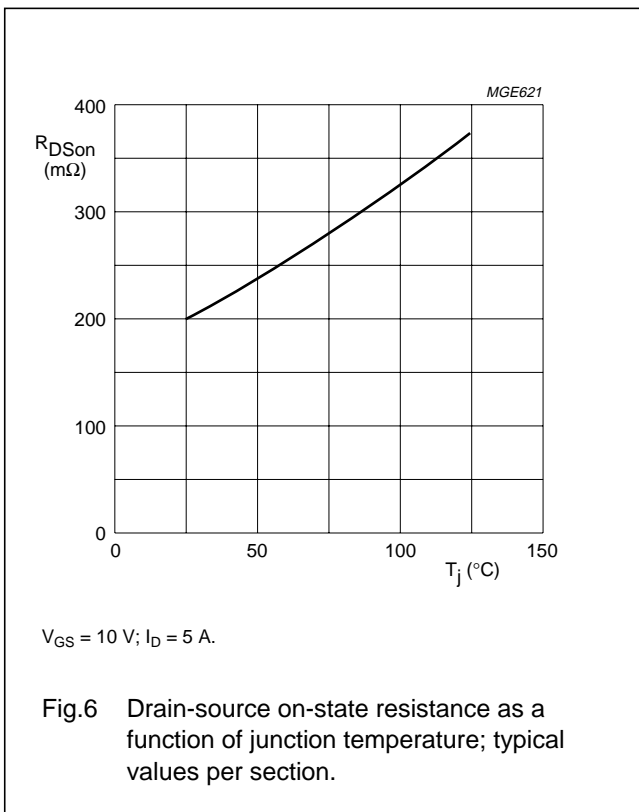
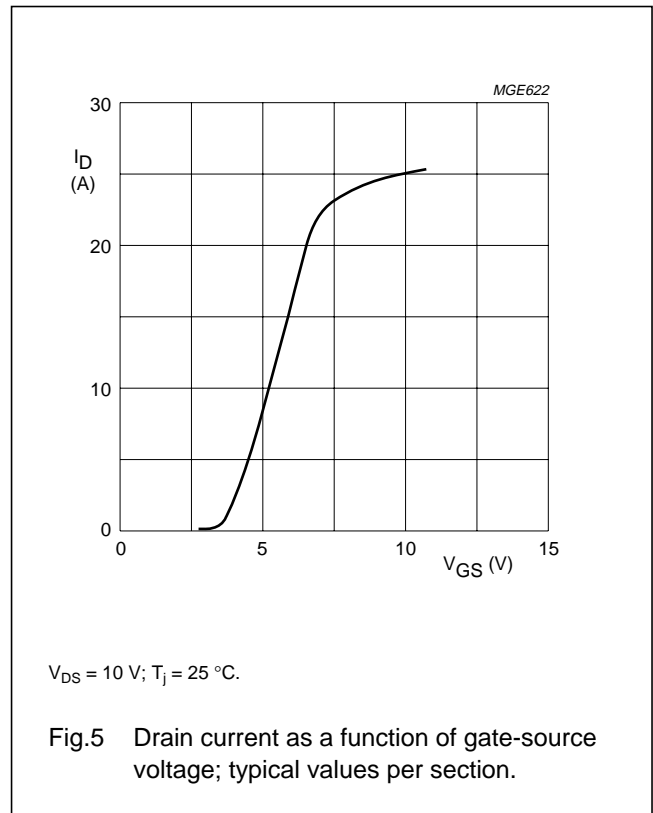
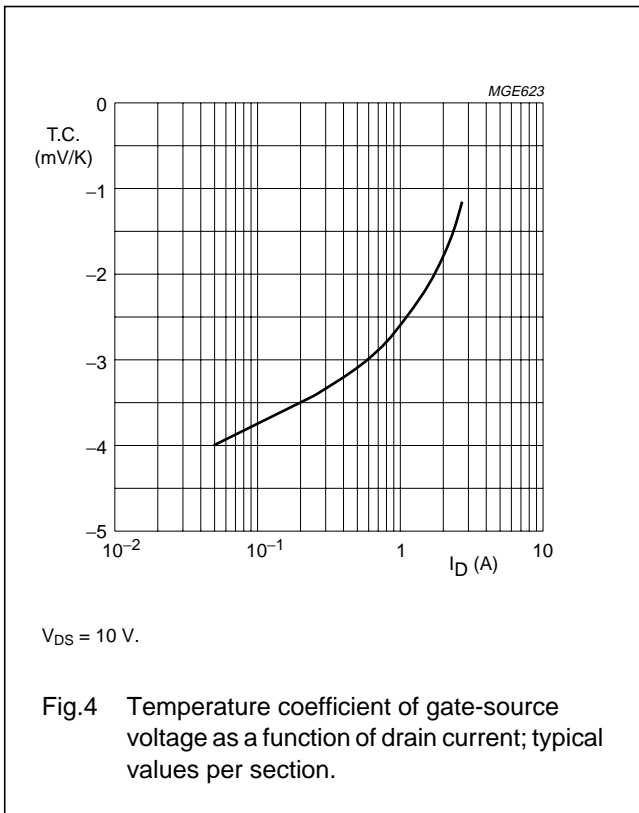

VHF push-pull power MOS transistor

BLF278

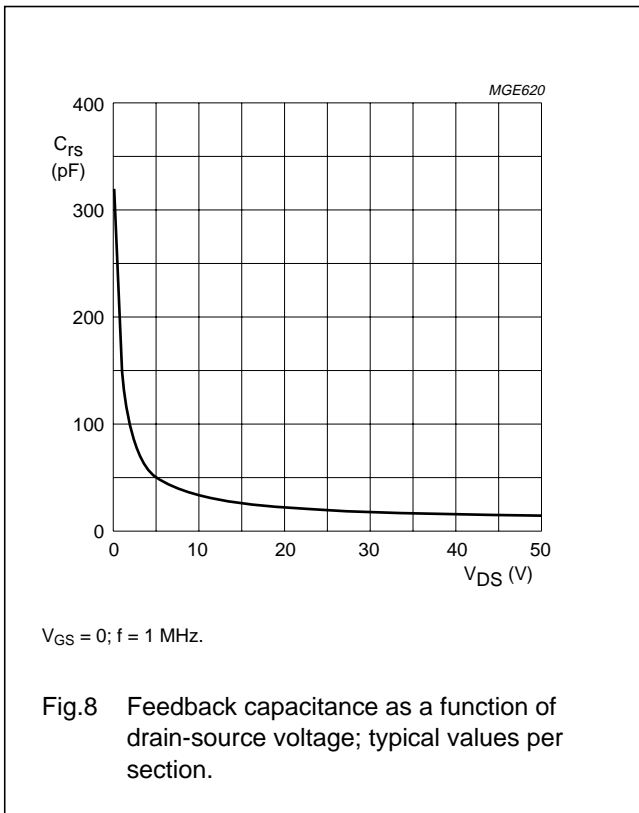

**APPLICATION INFORMATION**

**Class-B operation**

RF performance in CW operation in a common source push-pull test circuit.  $T_n = 25 \text{ }^\circ\text{C}$ ;  $R_{th \text{ mb-h}} = 0.15 \text{ K/W}$  unless otherwise specified.  $R_{GS} = 4 \text{ } \Omega$  per section; optimum load impedance per section =  $3.2 + j4.3 \text{ } \Omega$  ( $V_{DS} = 50 \text{ V}$ ).

| MODE OF OPERATION | f (MHz) | $V_{DS}$ (V) | $I_{DQ}$ (A)   | $P_L$ (W) | $G_p$ (dB)     | $\eta_D$ (%)   |
|-------------------|---------|--------------|----------------|-----------|----------------|----------------|
| CW, class-B       | 108     | 50           | $2 \times 0.1$ | 300       | >20<br>typ. 22 | >60<br>typ. 70 |
| CW, class-C       | 108     | 50           | $V_{GS} = 0$   | 300       | typ. 18        | typ. 80        |

**Ruggedness in class-B operation**

The BLF278 is capable of withstanding a load mismatch corresponding to  $V_{SWR} = 7:1$  through all phases under the following conditions:  $V_{DS} = 50 \text{ V}$ ;  $f = 108 \text{ MHz}$  at rated load power.

VHF push-pull power MOS transistor

BLF278

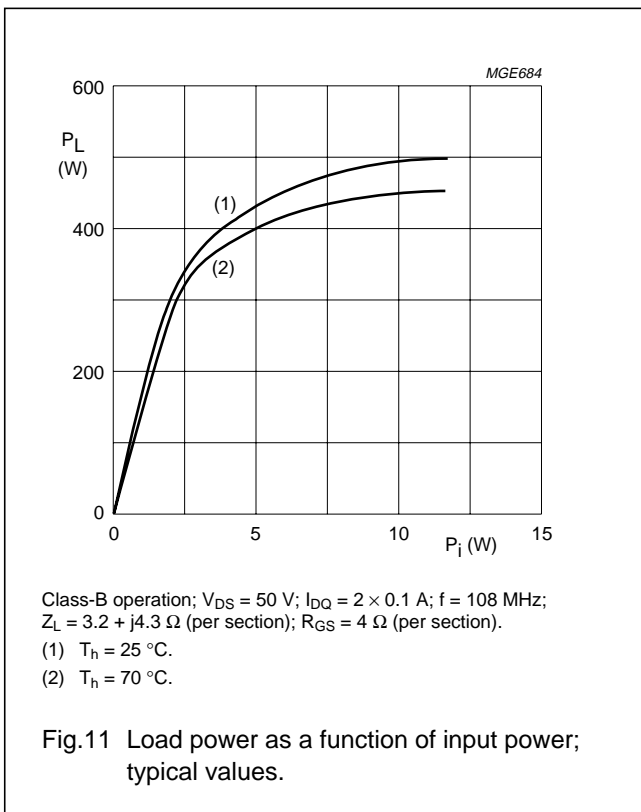
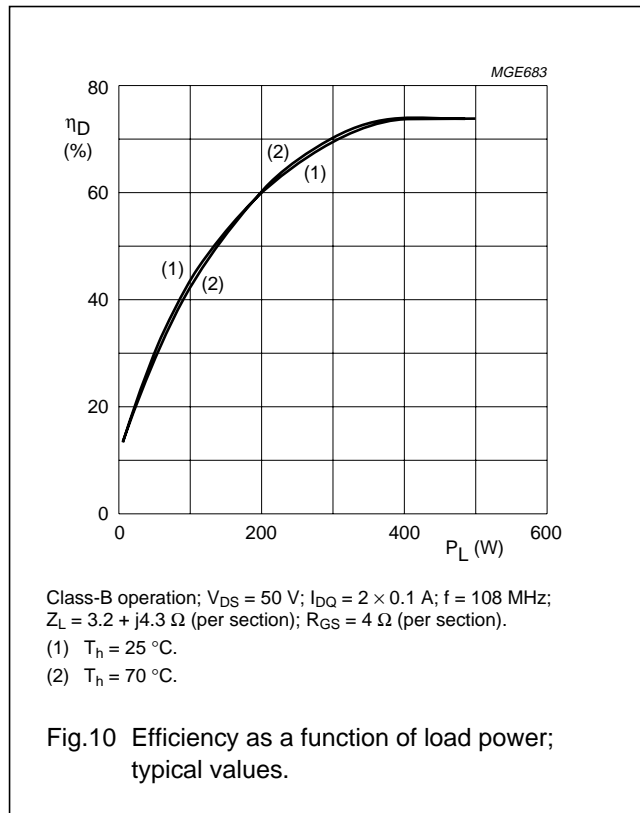
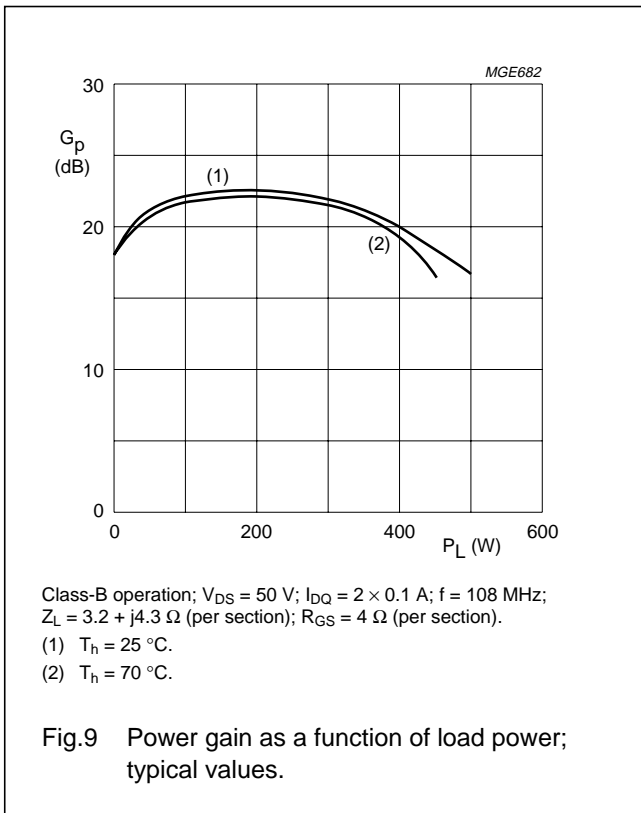

VHF push-pull power MOS transistor

BLF278

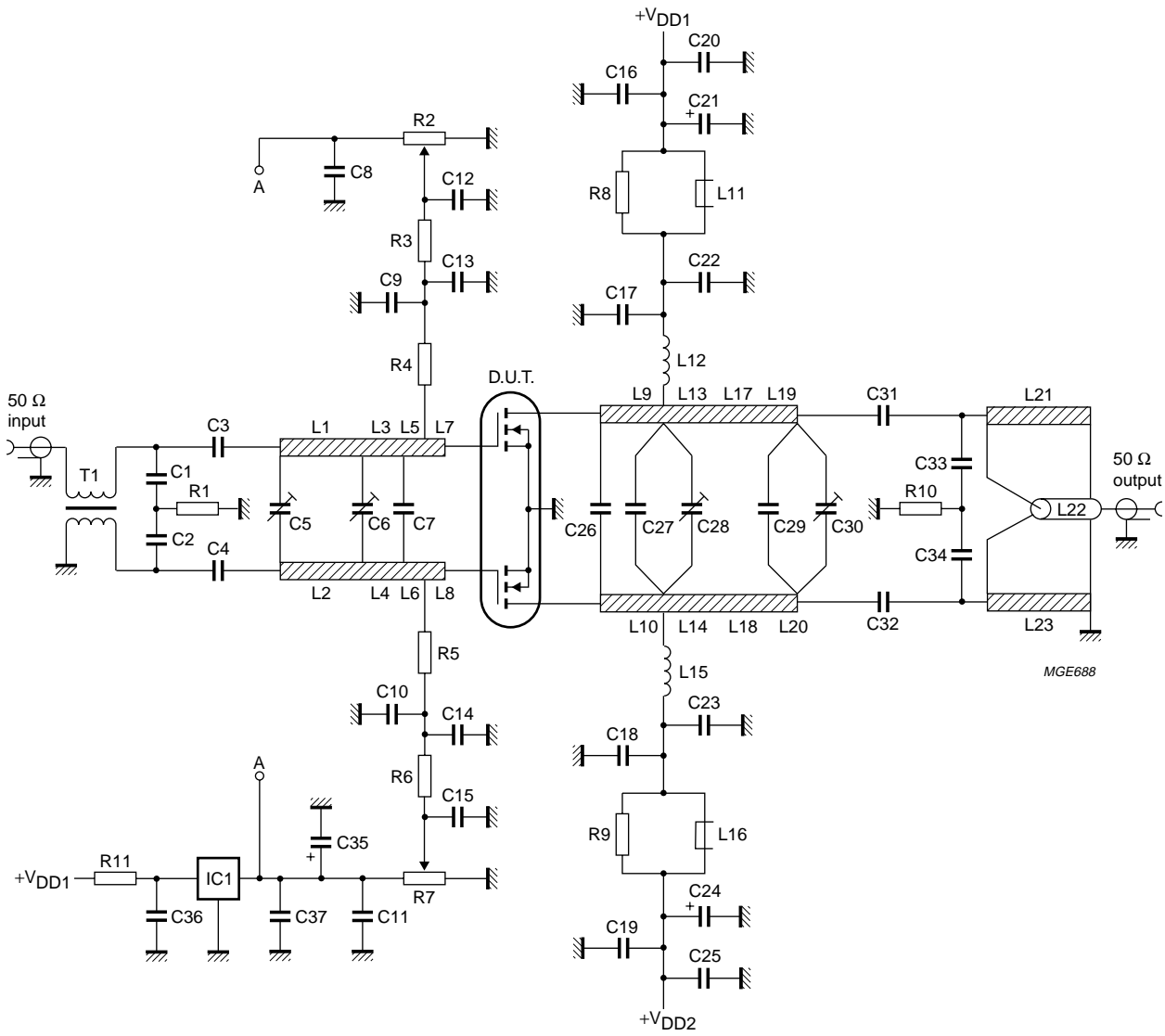

Fig.12 Class-B test circuit at f = 108 MHz.



## VHF push-pull power MOS transistor

BLF278

List of components (see Figs 12 and 13).

| COMPONENT                              | DESCRIPTION   | VALUE  | DIMENSIONS  | CATALOGUE NO.  |
|--|---|--|---|----------------|
| C1, C2, C33, C34                       | multilayer ceramic chip capacitor;<br>note 1              | 22 pF, 500 V                                     |   |                |
| C3, C4                                 | multilayer ceramic chip capacitor;<br>note 1              | 100 pF + 68 pF<br>in parallel, 500 V             |   |                |
| C5, C6, C28                            | film dielectric trimmer                                   | 5 to 60 pF                                       |   | 2222 809 08003 |
| C7                                     | multilayer ceramic chip capacitor;<br>note 1              | 2 × 100 pF +<br>1 × 120 pF in<br>parallel, 500 V |   |                |
| C8, C11, C12,<br>C15, C16, C19,<br>C36 | multilayer ceramic chip capacitor                         | 100 nF, 500 V                                    |   | 2222 852 47104 |
| C9, C10, C13,<br>C14, C20, C25         | multilayer ceramic chip capacitor;<br>note 1              | 1 nF, 500 V                                      |   |                |
| C17, C18, C22,<br>C23                  | multilayer ceramic chip capacitor;<br>note 1              | 470 pF, 500 V                                    |   |                |
| C21, C24, C35                          | electrolytic capacitor                                    | 10 µF, 63 V                                      |   |                |
| C26                                    | multilayer ceramic chip capacitor;<br>note 1              | 2 × 15 pF +<br>1 × 18 pF in<br>parallel, 500 V   |   |                |
| C27                                    | multilayer ceramic chip capacitor;<br>note 1              | 3 × 15 pF in<br>parallel, 500 V                  |   |                |
| C29                                    | multilayer ceramic chip capacitor;<br>note 1              | 2 × 18 pF +<br>1 × 15 pF in<br>parallel, 500 V   |   |                |
| C30                                    | film dielectric trimmer                                   | 2 to 18 pF                                       |   | 2222 809 09006 |
| C31, C32                               | multilayer ceramic chip capacitor;<br>note 1              | 3 × 43 pF in<br>parallel, 500 V                  |   |                |
| L1, L2                                 | stripline; note 2   | 43 Ω   | length 57.5 mm<br>width 6 mm                        |                |
| L3, L4                                 | stripline; note 2   | 43 Ω   | length 29.5 mm<br>width 6 mm                        |                |
| L5, L6                                 | stripline; note 2   | 43 Ω   | length 14 mm<br>width 6 mm                          |                |
| L7, L8                                 | stripline; note 2   | 43 Ω   | length 6 mm<br>width 6 mm                           |                |
| L9, L10                                | stripline; note 2   | 43 Ω   | length 17.5 mm<br>width 6 mm                        |                |
| L11, L16                               | 2 × grade 3B Ferroxcube wideband<br>HF chokes in parallel |  |   | 4312 020 36642 |
| L12, L15                               | 4 turns enamelled 2 mm copper wire                        | 85 nH  | length 13.5 mm<br>int. dia. 10 mm<br>leads 2 × 7 mm |                |
| L13, L14                               | stripline; note 2   | 43 Ω   | length 19.5 mm<br>width 6 mm                        |                |

## VHF push-pull power MOS transistor

BLF278

| COMPONENT | DESCRIPTION  | VALUE  | DIMENSIONS   | CATALOGUE NO.  |
|-----------|--|--|--|----------------|
| L17, L18  | stripline; note 2  | 43 $\Omega$                                    | length 24.5 mm<br>width 6 mm                         |                |
| L19, L20  | stripline; note 2  | 43 $\Omega$                                    | length 66 mm<br>width 6 mm                           |                |
| L21, L23  | stripline; note 2  | 50 $\Omega$                                    | length 160 mm<br>width 4.8 mm                        |                |
| L22       | semi-rigid cable; note 3   | 50 $\Omega$                                    | ext. dia. 3.6 mm<br>outer conductor<br>length 160 mm |                |
| R1        | metal film resistor  | 10 $\Omega$ , 0.4 W                            |  |                |
| R2, R7    | 10 turn potentiometer  | 50 k $\Omega$                                  |  |                |
| R3, R6    | metal film resistor  | 3 $\times$ 12.1 $\Omega$ in<br>parallel, 0.4 W |  |                |
| R4, R5    | metal film resistor  | 10 $\Omega$ ; 0.4 W                            |  |                |
| R8, R9    | metal film resistor  | 10 $\Omega$ $\pm$ 5%, 1 W                      |  |                |
| R10       | metal film resistor  | 4 $\times$ 10 $\Omega$ in<br>parallel, 1 W     |  |                |
| R11       | metal film resistor  | 5.11 k $\Omega$ , 1 W                          |  |                |
| IC1       | voltage regulator 78L05  |  |  |                |
| T1        | 1:1 Balun; 7 turns type 4C6 50 $\Omega$<br>coaxial cable wound around toroid |  | 14 $\times$ 9 $\times$ 5 mm                          | 4322 020 90770 |

**Notes**

1. American Technical Ceramics capacitor, type 100B or capacitor of same quality.
2. L1 to L10, L13, L14, L17 to L21 and L23 are striplines on a double copper-clad printed-circuit board, with fibre-glass PTFE dielectric ( $\epsilon_r = 2.2$ ), thickness  $\frac{1}{16}$  inch; thickness of copper sheet  $2 \times 35 \mu\text{m}$ .
3. L22 is soldered on to stripline L21.

VHF push-pull power MOS transistor

BLF278

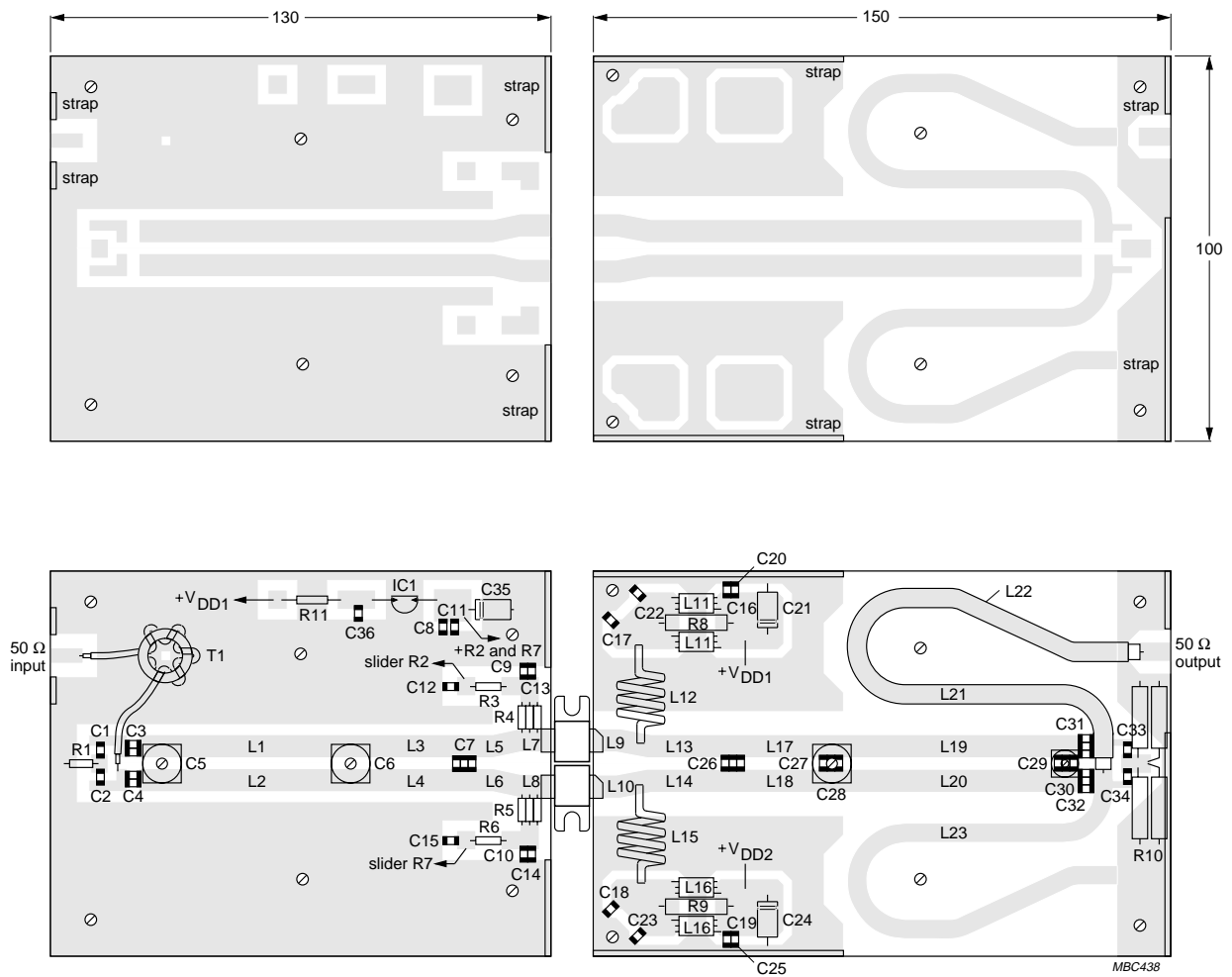

Dimensions in mm.

The circuit and components are situated on one side of the PTFE fibre-glass board, the other side being fully metallized to serve as an earth. Earth connections are made by means of copper straps for a direct contact between upper and lower sheets.

Fig.13 Printed-circuit board and component layout for 108 MHz class-B test circuit.

VHF push-pull power MOS transistor

BLF278

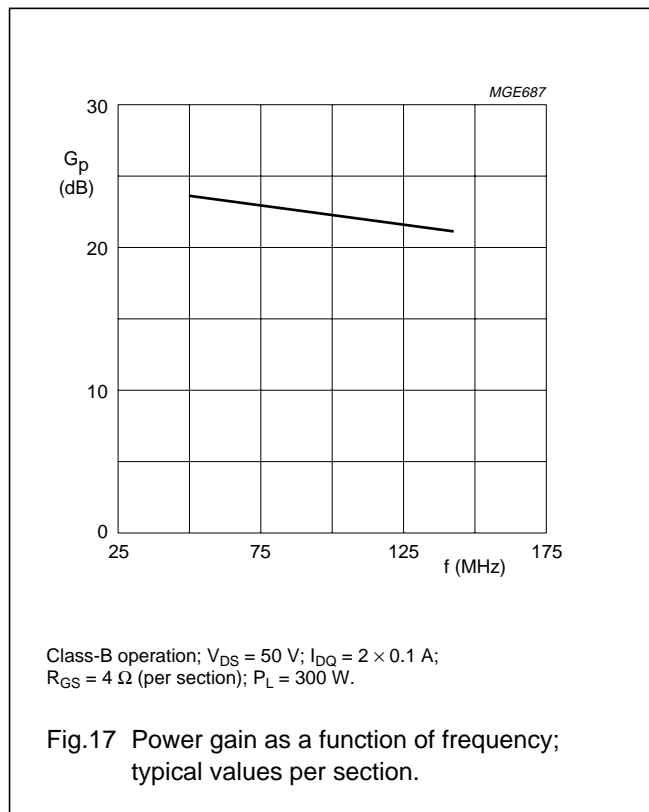
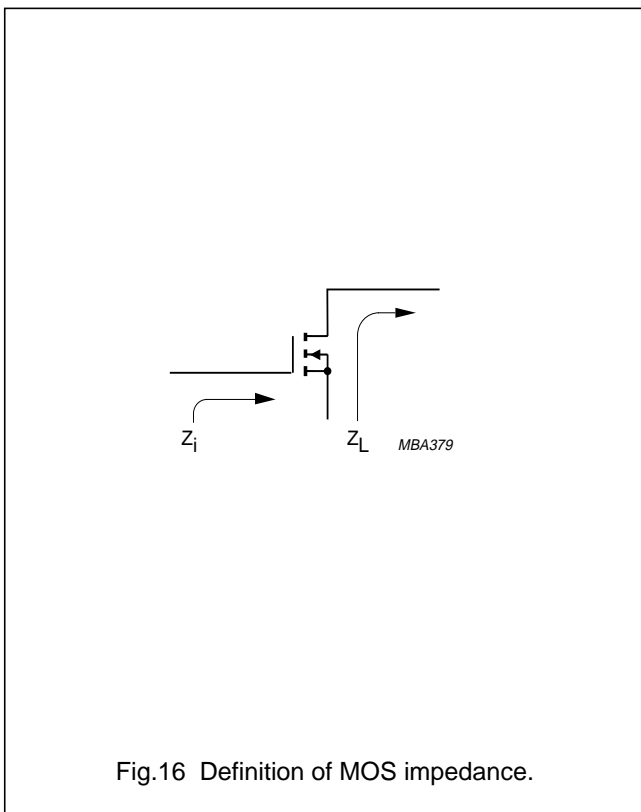
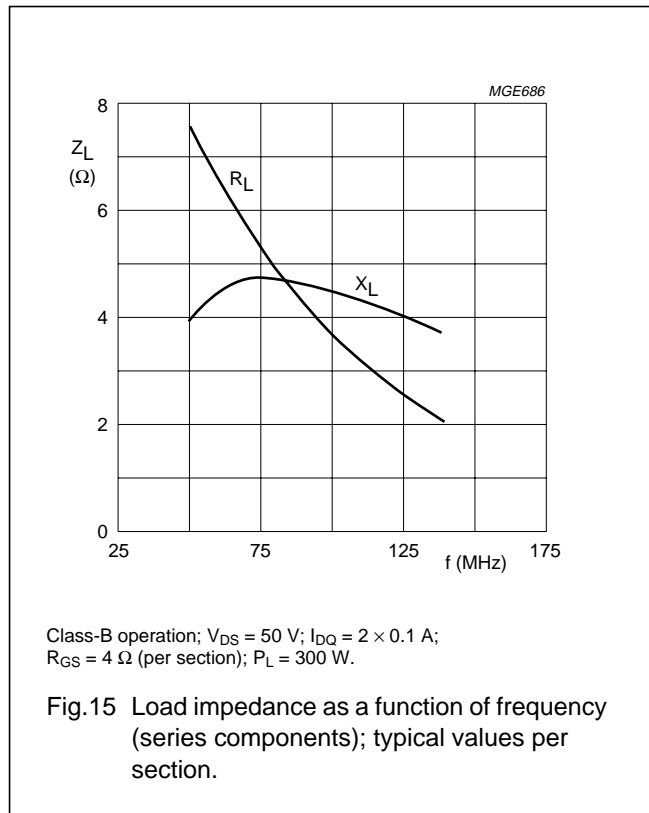
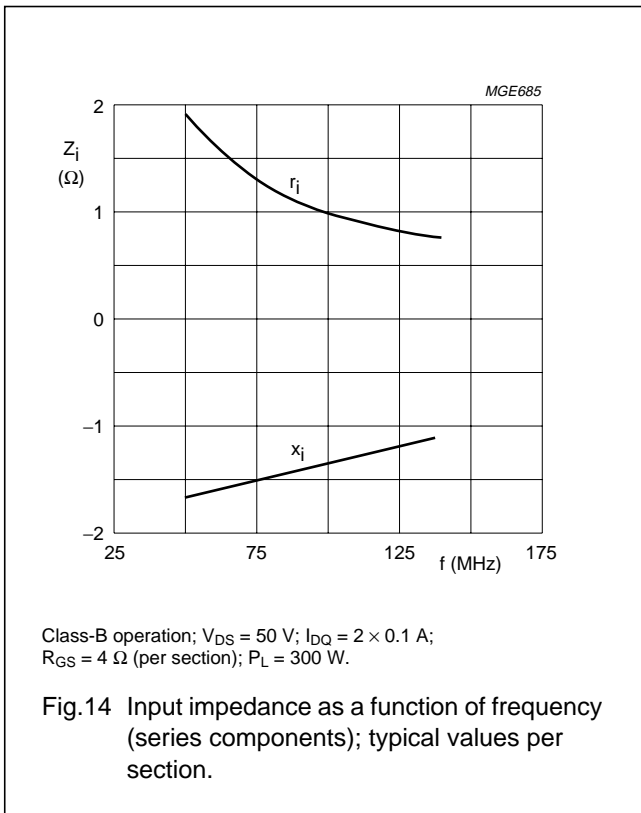

## VHF push-pull power MOS transistor

BLF278

**Class-AB operation**

RF performance in CW operation in a common source push-pull test circuit.  $T_h = 25\text{ }^\circ\text{C}$ ;  $R_{th\text{ mb-h}} = 0.15\text{ K/W}$  unless otherwise specified.  $R_{GS} = 2.8\text{ }\Omega$  per section; optimum load impedance per section =  $0.74 + j2\text{ }\Omega$ ; ( $V_{DS} = 50\text{ V}$ ).

| MODE OF OPERATION | f<br>(MHz) | $V_{DS}$<br>(V) | $I_{DQ}$<br>(A) | $P_L$<br>(W) | $G_p$<br>(dB)  | $\eta_D$<br>(%) |
|-------------------|------------|-----------------|-----------------|--------------|----------------|-----------------|
| CW, class-AB      | 225        | 50              | $2 \times 0.5$  | 250          | >14<br>typ. 16 | >50<br>typ. 55  |

**Ruggedness in class-AB operation**

The BLF278 is capable of withstanding a load mismatch corresponding to  $VSWR = 7:1$  through all phases under the following conditions:  $V_{DS} = 50\text{ V}$ ;  $f = 225\text{ MHz}$  at rated output power.

VHF push-pull power MOS transistor

BLF278

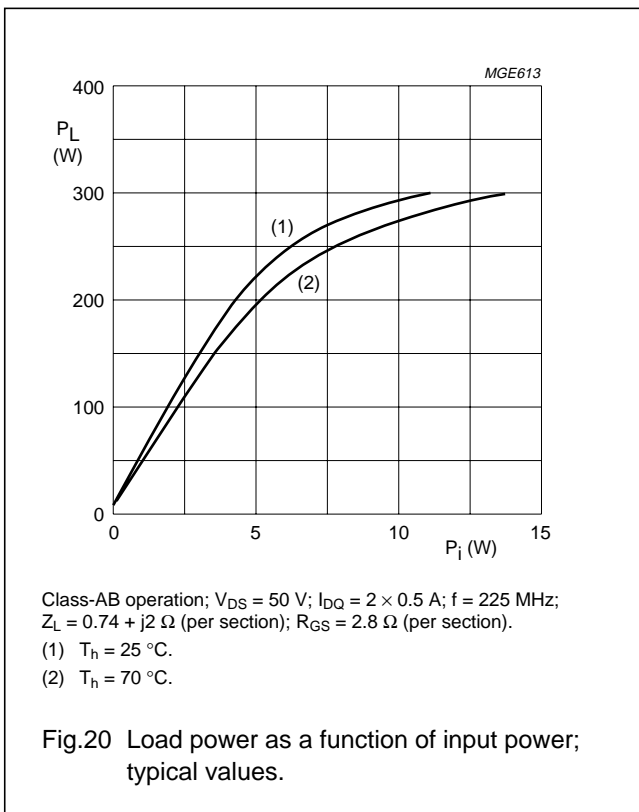
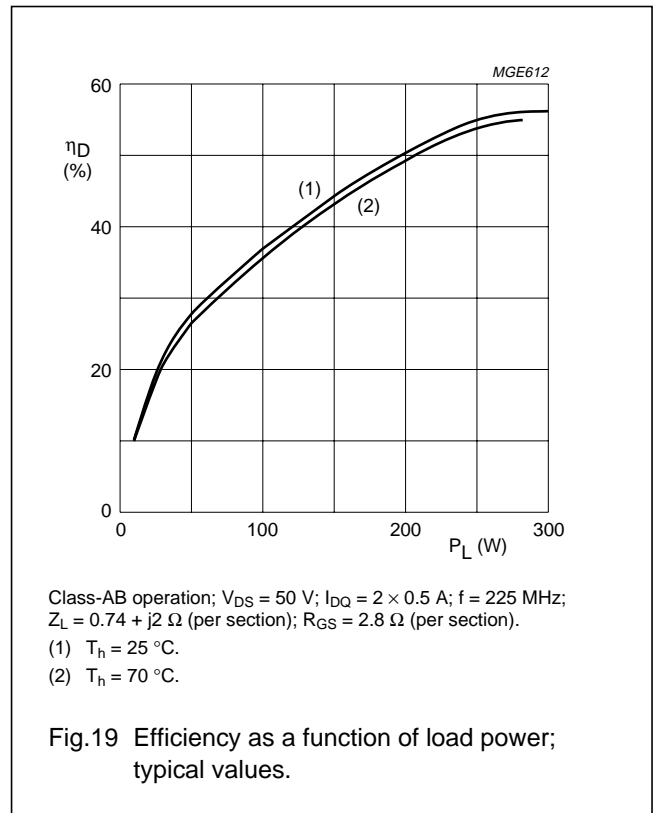
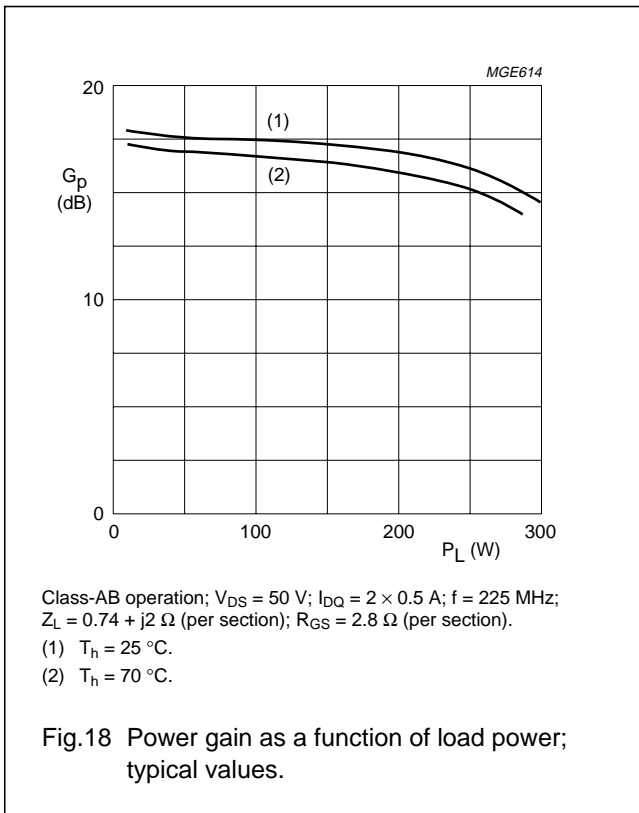

VHF push-pull power MOS transistor

BLF278

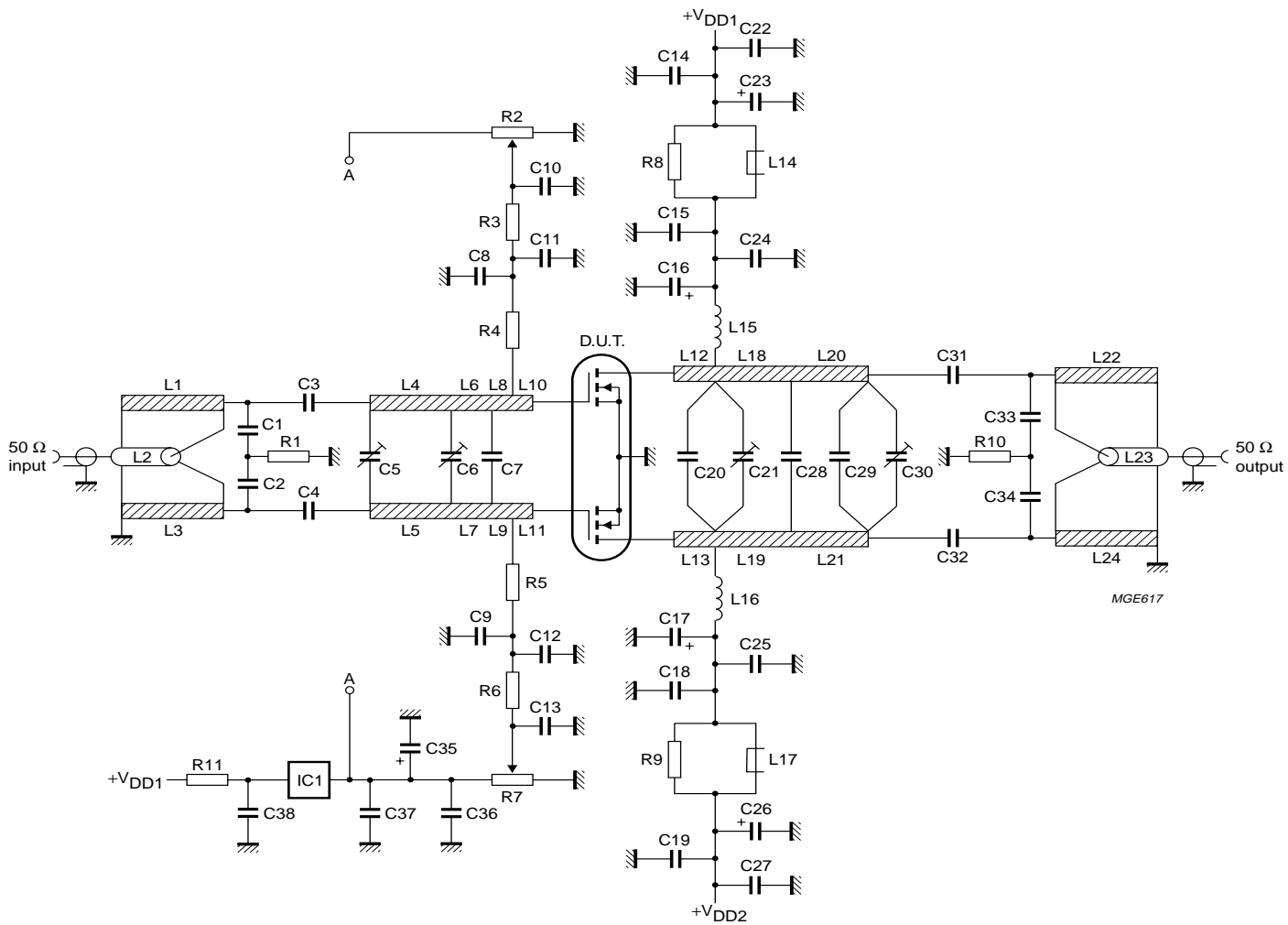

Fig.21 Class-AB test circuit at f = 225 MHz.

## VHF push-pull power MOS transistor

BLF278

List of components (see Figs 21 and 22).

| COMPONENT                  | DESCRIPTION                                  | VALUE  | DIMENSIONS  | CATALOGUE NO.  |
|----------------------------|--|--|---|----------------|
| C1, C2                     | multilayer ceramic chip capacitor;<br>note 1 | 27 pF, 500 V                                   |   |                |
| C3, C4, C31, C32           | multilayer ceramic chip capacitor;<br>note 1 | 3 × 18 pF<br>in parallel, 500 V                |   |                |
| C5                         | film dielectric trimmer                      | 4 to 40 pF                                     |   | 2222 809 08002 |
| C6, C30                    | film dielectric trimmer                      | 2 to 18 pF                                     |   | 2222 809 09006 |
| C7                         | multilayer ceramic chip capacitor;<br>note 1 | 100 pF, 500 V                                  |   |                |
| C8, C9, C15, C18           | MKT film capacitor                           | 1 μF, 63 V                                     |   | 2222 371 11105 |
| C10, C13, C14,<br>C19, C36 | multilayer ceramic chip capacitor            | 100 nF, 50 V                                   |   | 2222 852 47104 |
| C11, C12                   | multilayer ceramic chip capacitor;<br>note 1 | 2 × 1 nF in parallel,<br>500 V                 |   |                |
| C16, C17                   | electrolytic capacitor                       | 220 μF, 63 V                                   |   |                |
| C20                        | multilayer ceramic chip capacitor;<br>note 1 | 3 × 33 pF in<br>parallel, 500 V                |   |                |
| C21                        | film dielectric trimmer                      | 2 to 9 pF                                      |   | 2222 809 09005 |
| C22, C27, C37,<br>C38      | multilayer ceramic chip capacitor;<br>note 1 | 1 nF, 500 V                                    |   |                |
| C23, C26, C35              | electrolytic capacitor                       | 10 μF, 63 V                                    |   |                |
| C24, C25                   | multilayer ceramic chip capacitor;<br>note 1 | 2 × 470 pF in<br>parallel, 500 V               |   |                |
| C28                        | multilayer ceramic chip capacitor;<br>note 1 | 2 × 10 pF +<br>1 × 18 pF in<br>parallel, 500 V |   |                |
| C29                        | multilayer ceramic chip capacitor;<br>note 1 | 2 × 5.6 pF in<br>parallel, 500 V               |   |                |
| C33, C34                   | multilayer ceramic chip capacitor;<br>note 1 | 5.6 pF, 500 V                                  |   |                |
| L1, L3, L22, L24           | stripline; note 2                            | 50 Ω   | length 80 mm<br>width 4.8 mm                        |                |
| L2, L23                    | semi-rigid cable; note 3                     | 50 Ω   | ext. dia. 3.6 mm<br>outer conductor<br>length 80 mm |                |
| L4, L5                     | stripline; note 2                            | 43 Ω   | length 24 mm<br>width 6 mm                          |                |
| L6, L7                     | stripline; note 2                            | 43 Ω   | length 14.5 mm<br>width 6 mm                        |                |
| L8, L9                     | stripline; note 2                            | 43 Ω   | length 4.4 mm<br>width 6 mm                         |                |
| L10, L11                   | stripline; note 2                            | 43 Ω   | length 3.2 mm<br>width 6 mm                         |                |
| L12, L13                   | stripline; note 2                            | 43 Ω   | length 15 mm<br>width 6 mm                          |                |



## VHF push-pull power MOS transistor

BLF278

| COMPONENT | DESCRIPTION  | VALUE                          | DIMENSIONS                                      | CATALOGUE NO.  |
|-----------|--|--------------------------------|---|----------------|
| L14, L17  | 2 × grade 3B Ferroxcube wideband HF chokes in parallel |                                |   | 4312 020 36642 |
| L15, L16  | 1 $\frac{3}{4}$ turns enamelled 2 mm copper wire       | 40 nH                          | int. dia. 10 mm<br>leads 2 × 7 mm<br>space 1 mm |                |
| L18, L19  | stripline; note 2                                      | 43 Ω                           | length 13 mm<br>width 6 mm                      |                |
| L20, L21  | stripline; note 2                                      | 43 Ω                           | length 29.5 mm<br>width 6 mm                    |                |
| R1        | metal film resistor                                    | 10 Ω, 0.4 W                    |   |                |
| R2, R7    | 10 turns potentiometer                                 | 50 kΩ                          |   |                |
| R3, R6    | metal film resistor                                    | 1 kΩ, 0.4 W                    |   |                |
| R4, R5    | metal film resistor                                    | 2 × 5.62 Ω, in parallel, 0.4 W |   |                |
| R8, R9    | metal film resistor                                    | 10 Ω ±5%, 1 W                  |   |                |
| R10       | metal film resistor                                    | 4 × 42.2 Ω in parallel, 1 W    |   |                |
| R11       | metal film resistor                                    | 5.11 kΩ, 1 W                   |   |                |
| IC1       | voltage regulator 78L05                                |                                |   |                |

**Notes**

1. American Technical Ceramics capacitor, type 100B or other capacitor of the same quality.
2. L1, L3 to L13, L18 to L22 and L24 are microstriplines on a double copper-clad printed-circuit board, with fibre-glass reinforced PTFE dielectric ( $\epsilon_r = 2.2$ ), thickness  $\frac{1}{16}$  inch; thickness of copper sheet  $2 \times 35 \mu\text{m}$ .
3. L2 and L23 are soldered on to striplines L1 and L24 respectively.

VHF push-pull power MOS transistor

BLF278

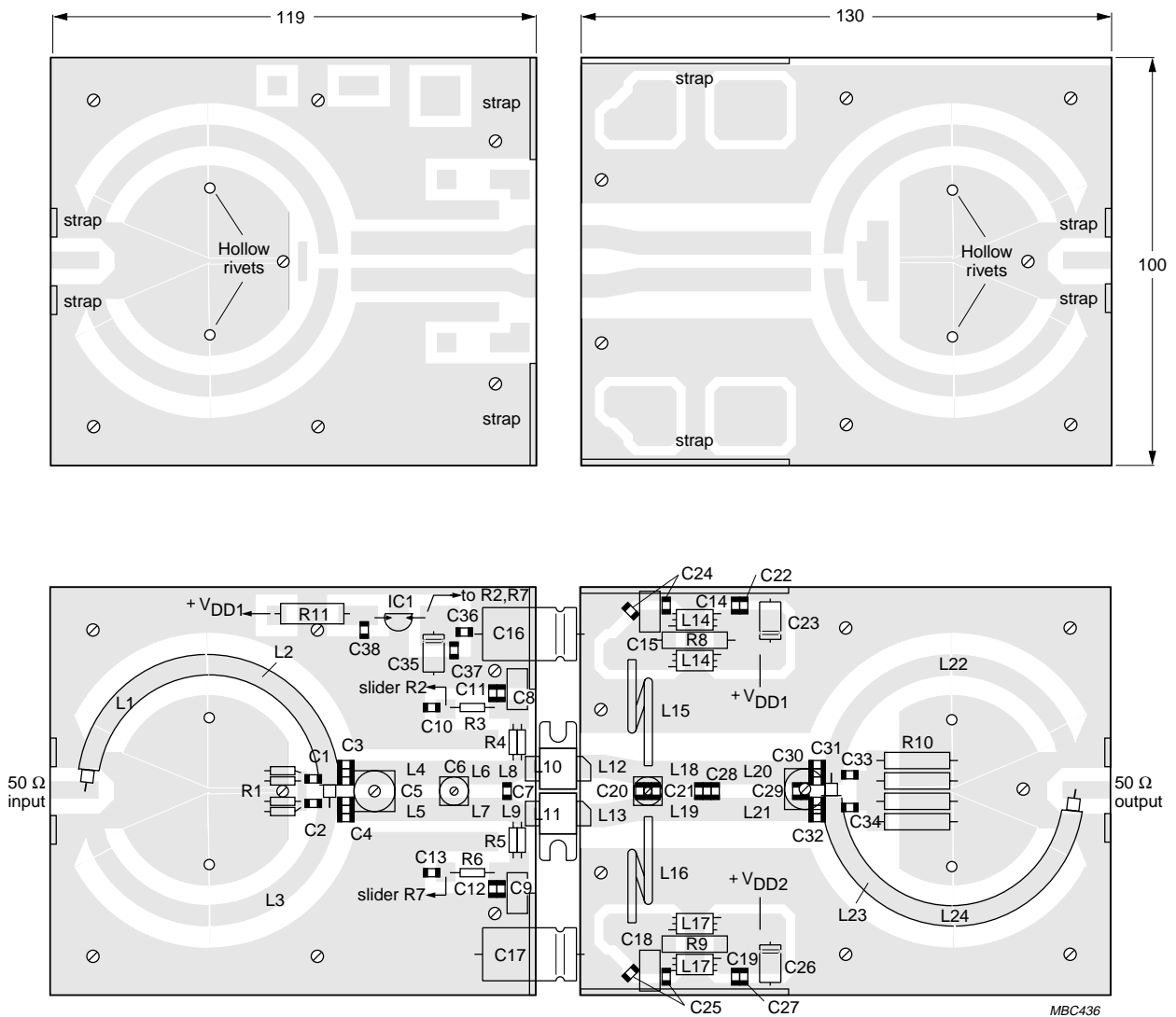

Dimensions in mm.

The circuit and components are situated on one side of the PTFE fibre-glass board, the other side being fully metallized to serve as an earth. Earth connections are made by means of copper straps for a direct contact between upper and lower sheets.

Fig.22 Printed-circuit board and component layout for 225 MHz class-AB test circuit.

VHF push-pull power MOS transistor

BLF278

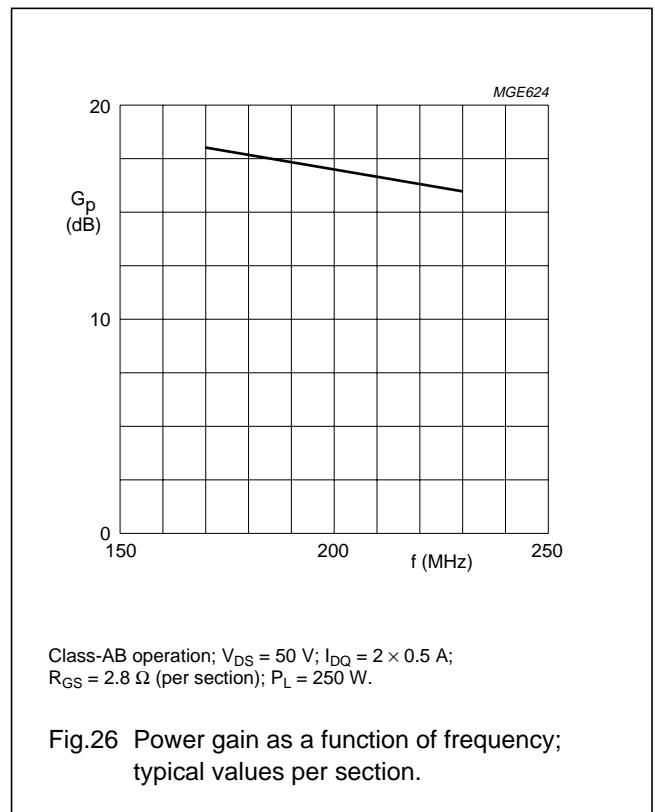
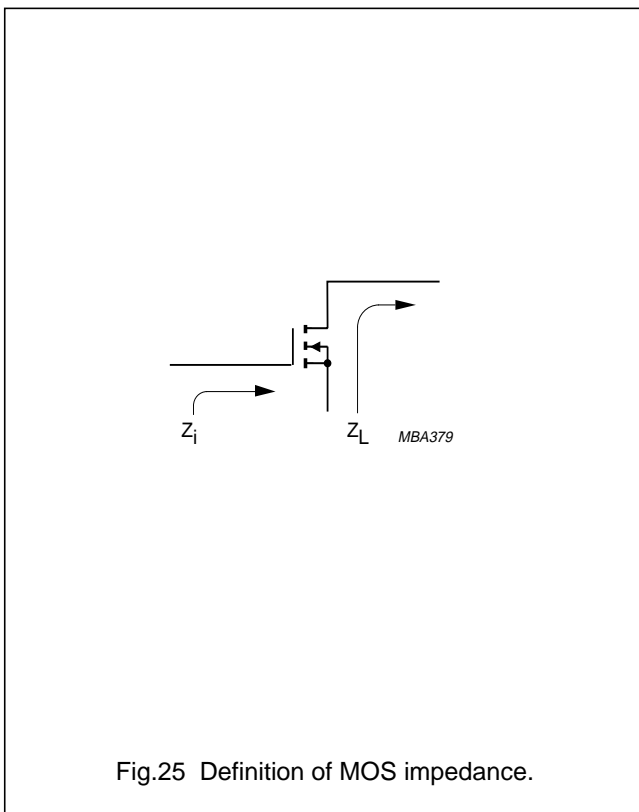
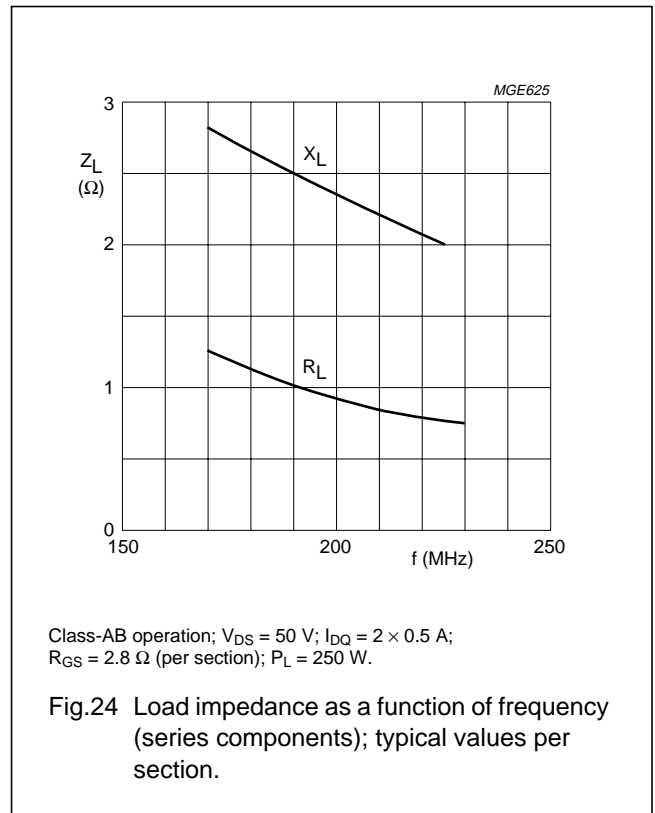
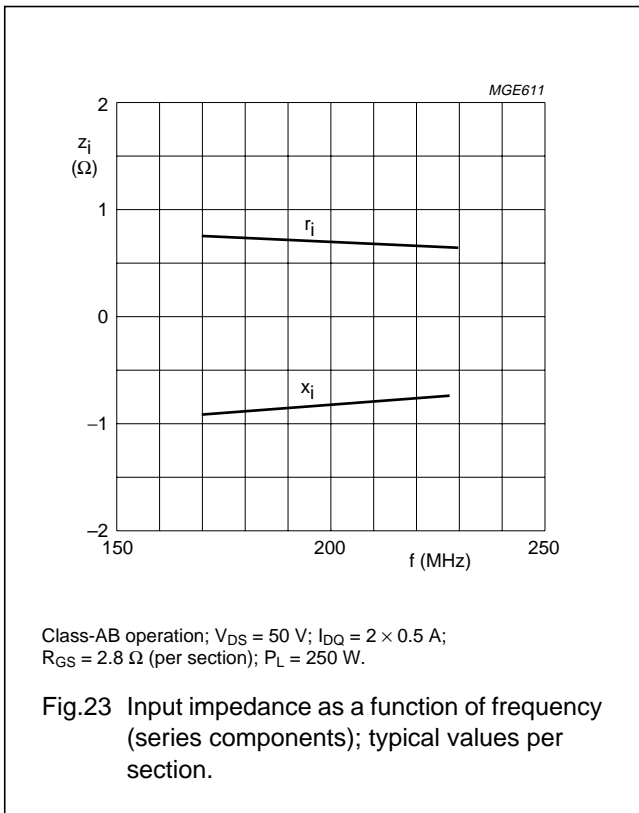

## VHF push-pull power MOS transistor

BLF278

**BLF278 scattering parameters** $V_{DS} = 50\text{ V}$ ;  $I_D = 500\text{ mA}$ ; note 1

| f (MHz) | S <sub>11</sub> |        | S <sub>21</sub> |       | S <sub>12</sub> |       | S <sub>22</sub> |        |
|---------|-----------------|--------|-----------------|-------|-----------------|-------|-----------------|--------|
|         | S <sub>11</sub> | ∠ Φ    | S <sub>21</sub> | ∠ Φ   | S <sub>12</sub> | ∠ Φ   | S <sub>22</sub> | ∠ Φ    |
| 5       | 0.87            | -142.1 | 60.05           | 104.3 | 0.00            | -19.4 | 0.83            | 160.9  |
| 10      | 0.88            | -159.8 | 32.09           | 91.4  | 0.00            | 0.68  | 167.5           | 165.8  |
| 20      | 0.88            | -169.0 | 15.70           | 77.3  | 0.01            | 13.4  | 0.62            | 177.6  |
| 30      | 0.88            | -171.2 | 9.98            | 68.4  | 0.01            | 3.4   | 0.64            | -175.8 |
| 40      | 0.89            | -172.2 | 6.99            | 61.0  | 0.01            | -4.4  | 0.66            | -171.2 |
| 50      | 0.91            | -172.9 | 5.24            | 55.0  | 0.01            | -10.3 | 0.70            | -168.1 |
| 60      | 0.92            | -173.5 | 4.08            | 49.6  | 0.01            | -15.0 | 0.74            | -166.8 |
| 70      | 0.93            | -174.1 | 3.26            | 44.9  | 0.01            | -18.3 | 0.78            | -166.5 |
| 80      | 0.94            | -174.7 | 2.66            | 41.0  | 0.01            | -19.8 | 0.80            | -166.5 |
| 90      | 0.95            | -175.2 | 2.22            | 37.5  | 0.00            | -19.7 | 0.83            | -166.7 |
| 100     | 0.95            | -175.7 | 1.88            | 34.0  | 0.00            | -18.0 | 0.85            | -167.4 |
| 125     | 0.97            | -176.9 | 1.27            | 26.8  | 0.00            | -1.9  | 0.88            | -169.4 |
| 150     | 0.97            | -177.9 | 0.91            | 22.7  | 0.00            | 35.3  | 0.91            | -170.0 |
| 175     | 0.98            | -178.7 | 0.69            | 19.5  | 0.00            | 65.3  | 0.94            | -170.8 |
| 200     | 0.98            | -179.5 | 0.54            | 16.0  | 0.00            | 78.0  | 0.95            | -172.4 |
| 250     | 0.99            | 179.2  | 0.35            | 12.1  | 0.01            | 86.7  | 0.96            | -174.0 |
| 300     | 0.99            | 178.1  | 0.25            | 9.1   | 0.01            | 87.8  | 0.98            | -175.5 |
| 350     | 0.99            | 177.1  | 0.19            | 8.2   | 0.01            | 90.3  | 0.98            | -176.5 |
| 400     | 0.99            | 176.1  | 0.14            | 7.2   | 0.01            | 91.4  | 0.99            | -177.6 |
| 450     | 0.99            | 175.1  | 0.11            | 8.1   | 0.02            | 92.2  | 0.99            | -178.3 |
| 500     | 0.99            | 174.2  | 0.09            | 9.7   | 0.02            | 91.5  | 0.99            | -179.2 |
| 600     | 0.99            | 172.4  | 0.07            | 14.8  | 0.02            | 91.4  | 0.99            | 179.5  |
| 700     | 0.99            | 170.7  | 0.05            | 24.0  | 0.03            | 91.6  | 0.99            | 178.3  |
| 800     | 0.99            | 168.9  | 0.04            | 35.6  | 0.03            | 92.5  | 1.00            | 177.1  |
| 900     | 0.99            | 167.1  | 0.04            | 46.0  | 0.04            | 93.1  | 1.00            | 176.0  |
| 1000    | 0.99            | 165.2  | 0.04            | 60.3  | 0.04            | 94.1  | 1.00            | 175.0  |

**Note**

1. For more extensive s-parameters see internet:  
<http://www.semiconductors.philips.com/markets/communications/wirelesscommunications/broadcast>.

# VHF push-pull power MOS transistor

BLF278

## PACKAGE OUTLINE

Flanged double-ended ceramic package; 2 mounting holes; 4 leads

SOT262A1

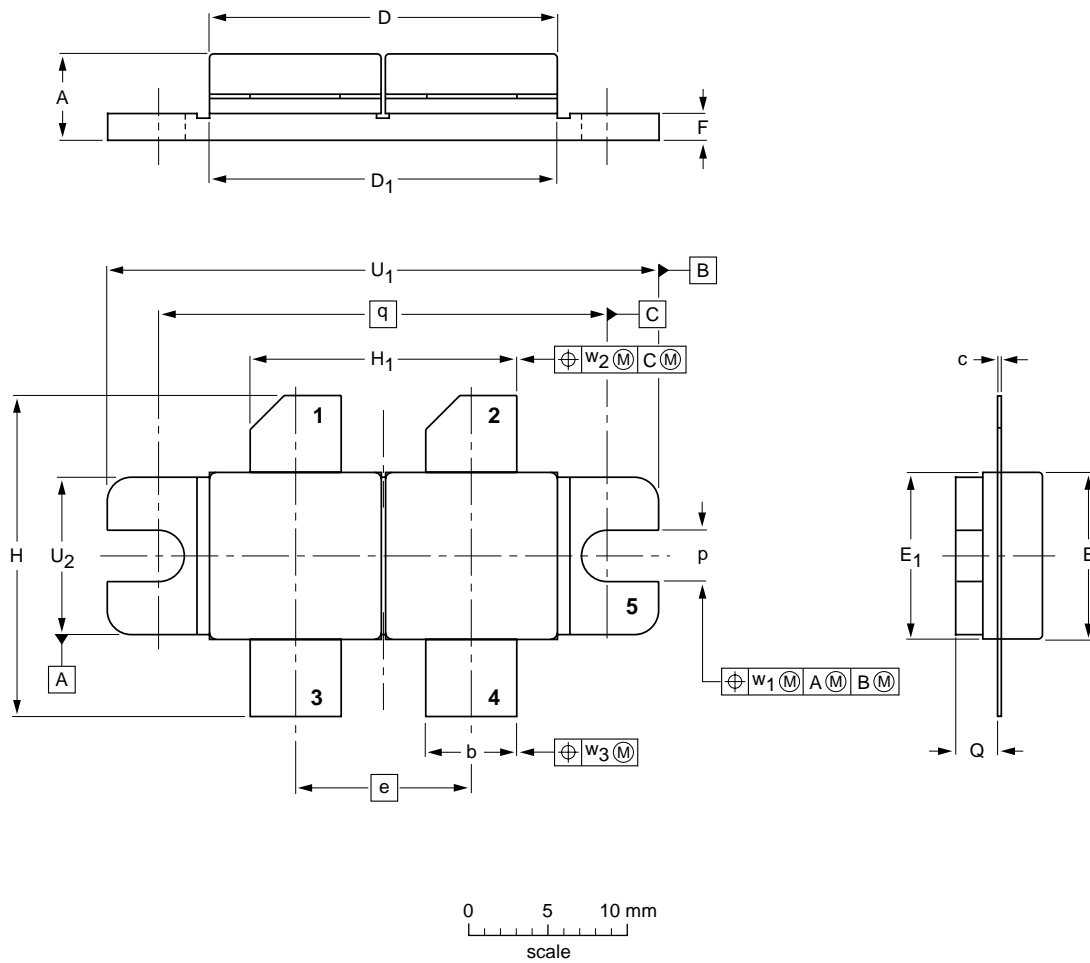

DIMENSIONS (millimetre dimensions are derived from the original inch dimensions)

| UNIT   | A              | b              | c              | D              | D <sub>1</sub> | e     | E              | E <sub>1</sub> | F              | H              | H <sub>1</sub> | p              | Q              | q     | U <sub>1</sub> | U <sub>2</sub> | w <sub>1</sub> | w <sub>2</sub> | w <sub>3</sub> |
|--------|----------------|----------------|----------------|----------------|----------------|-------|----------------|----------------|----------------|----------------|----------------|----------------|----------------|-------|----------------|----------------|----------------|----------------|----------------|
| mm     | 5.77<br>5.00   | 5.85<br>5.58   | 0.16<br>0.10   | 22.17<br>21.46 | 21.98<br>21.71 | 11.05 | 10.27<br>10.05 | 10.29<br>10.03 | 1.78<br>1.52   | 21.08<br>19.56 | 17.02<br>16.51 | 3.28<br>3.02   | 2.85<br>2.59   | 27.94 | 34.17<br>33.90 | 9.91<br>9.65   | 0.25           | 0.51           | 0.25           |
| inches | 0.227<br>0.197 | 0.230<br>0.220 | 0.006<br>0.004 | 0.873<br>0.845 | 0.865<br>0.855 | 0.435 | 0.404<br>0.396 | 0.405<br>0.396 | 0.070<br>0.060 | 0.830<br>0.770 | 0.670<br>0.650 | 0.129<br>0.119 | 0.112<br>0.102 | 1.100 | 1.345<br>1.335 | 0.390<br>0.380 | 0.010          | 0.020          | 0.010          |

| OUTLINE VERSION | REFERENCES |       |      |  | EUROPEAN PROJECTION | ISSUE DATE |
|-----------------|------------|-------|------|--|---------------------|------------|
|                 | IEC        | JEDEC | EIAJ |  |                     |            |
| SOT262A1        |            |       |      |  |                     | 99-03-29   |

## VHF push-pull power MOS transistor

BLF278

## DATA SHEET STATUS

| LEVEL | DATA SHEET STATUS <sup>(1)</sup> | PRODUCT STATUS <sup>(2)(3)</sup> | DEFINITION   |
|-------|----------------------------------|----------------------------------|--|
| I     | Objective data                   | Development                      | This data sheet contains data from the objective specification for product development. Philips Semiconductors reserves the right to change the specification in any manner without notice.  |
| II    | Preliminary data                 | Qualification                    | This data sheet contains data from the preliminary specification. Supplementary data will be published at a later date. Philips Semiconductors reserves the right to change the specification without notice, in order to improve the design and supply the best possible product.             |
| III   | Product data                     | Production                       | This data sheet contains data from the product specification. Philips Semiconductors reserves the right to make changes at any time in order to improve the design, manufacturing and supply. Relevant changes will be communicated via a Customer Product/Process Change Notification (CPCN). |

## Notes

1. Please consult the most recently issued data sheet before initiating or completing a design.
2. The product status of the device(s) described in this data sheet may have changed since this data sheet was published. The latest information is available on the Internet at URL <http://www.semiconductors.philips.com>.
3. For data sheets describing multiple type numbers, the highest-level product status determines the data sheet status.

## DEFINITIONS

**Short-form specification** — The data in a short-form specification is extracted from a full data sheet with the same type number and title. For detailed information see the relevant data sheet or data handbook.

**Limiting values definition** — Limiting values given are in accordance with the Absolute Maximum Rating System (IEC 60134). Stress above one or more of the limiting values may cause permanent damage to the device. These are stress ratings only and operation of the device at these or at any other conditions above those given in the Characteristics sections of the specification is not implied. Exposure to limiting values for extended periods may affect device reliability.

**Application information** — Applications that are described herein for any of these products are for illustrative purposes only. Philips Semiconductors make no representation or warranty that such applications will be suitable for the specified use without further testing or modification.

## DISCLAIMERS

**Life support applications** — These products are not designed for use in life support appliances, devices, or systems where malfunction of these products can reasonably be expected to result in personal injury. Philips Semiconductors customers using or selling these products for use in such applications do so at their own risk and agree to fully indemnify Philips Semiconductors for any damages resulting from such application.

**Right to make changes** — Philips Semiconductors reserves the right to make changes in the products - including circuits, standard cells, and/or software - described or contained herein in order to improve design and/or performance. When the product is in full production (status 'Production'), relevant changes will be communicated via a Customer Product/Process Change Notification (CPCN). Philips Semiconductors assumes no responsibility or liability for the use of any of these products, conveys no licence or title under any patent, copyright, or mask work right to these products, and makes no representations or warranties that these products are free from patent, copyright, or mask work right infringement, unless otherwise specified.

# ***Philips Semiconductors – a worldwide company***

## **Contact information**

For additional information please visit <http://www.semiconductors.philips.com>. Fax: +31 40 27 24825

For sales offices addresses send e-mail to: [sales.addresses@www.semiconductors.philips.com](mailto:sales.addresses@www.semiconductors.philips.com).

© Koninklijke Philips Electronics N.V. 2003

SCA75

All rights are reserved. Reproduction in whole or in part is prohibited without the prior written consent of the copyright owner.

The information presented in this document does not form part of any quotation or contract, is believed to be accurate and reliable and may be changed without notice. No liability will be accepted by the publisher for any consequence of its use. Publication thereof does not convey nor imply any license under patent- or other industrial or intellectual property rights.

Printed in The Netherlands

613524/04/pp23

Date of release: 2003 Sep 19

Document order number: 9397 750 11599

*Let's make things better.*

**Philips  
Semiconductors**



**PHILIPS**