

SPECIFICATION

Part No. : **FW.91.TNC.M**

Product Name : Penta-band cellular 2G/3G
GSM/CDMA/UMTS
Flexible Whip Monopole Antenna
850/900/1800/1900/2100 MHz

Feature : IP67
Robust Inner Steel Core
TNC Male Connector
RoHS Compliant✓



1. Specification

| CELLULAR | | | | | |
|----------------------------|----------------------------|---------|-----------|-----------|-----------|
| Frequency (MHz) | 824~896 | 880~960 | 1710~1880 | 1850~1990 | 1710~2170 |
| Peak Gain (dBi) | | | | | |
| Free Space | -0.7 | -0.9 | 1.7 | 2.5 | 2.2 |
| With Ground plane(30x30cm) | 2.5 | 3.0 | 4.5 | 4.5 | 3.5 |
| L - Bracket | 3.0 | 3.0 | 3.5 | 4.5 | 2.5 |
| Average Gain (dBi) | | | | | |
| Free Space | -5.7 | -5.3 | -2.3 | -1.7 | -3.9 |
| With Ground plane(30x30cm) | -2.2 | -2.6 | -2.3 | -1.7 | -2.2 |
| L - Bracket | -3.0 | -2.6 | -2.3 | -1.7 | -3.0 |
| Efficiency | | | | | |
| Free Space | 27% | 30% | 59% | 68% | 40% |
| With Ground plane(30x30cm) | 60% | 55% | 59% | 68% | 60% |
| L - Bracket | 50% | 55% | 59% | 68% | 50% |
| Impedance | 50Ω | | | | |
| Polarization | Linear | | | | |
| Radiation Pattern | Omni | | | | |
| Input Power | 50 W | | | | |
| MECHANICAL | | | | | |
| Dimensions | Height 255 ± 5 mm | | | | |
| Base Diameter | 16.05 ± 0.2 mm | | | | |
| Whip Diameter | 4 ± 0.2 mm | | | | |
| Casing | ABS | | | | |
| Connector | TNC Male | | | | |
| ENVIRONMENTAL | | | | | |
| Temperature Range | -40°C to 85°C | | | | |
| Humidity | Non-condensing 65°C 95% RH | | | | |

2. Antenna Characteristics

2.1. Return Loss

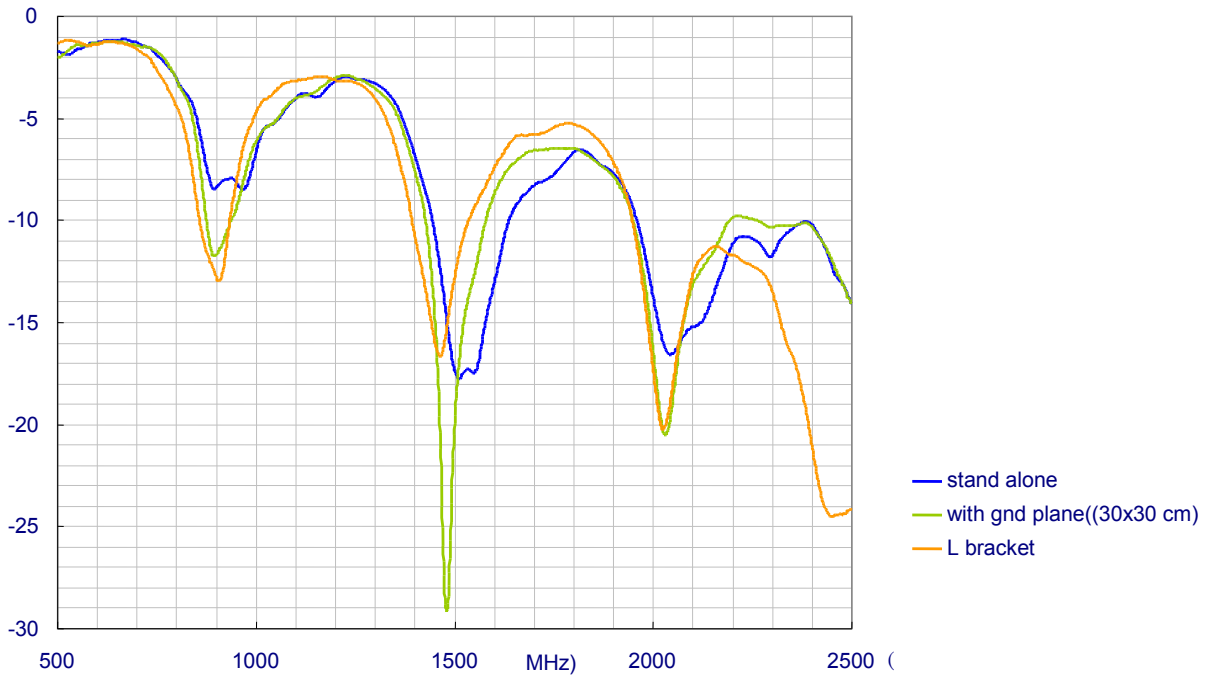

2.2. Antenna Efficiency

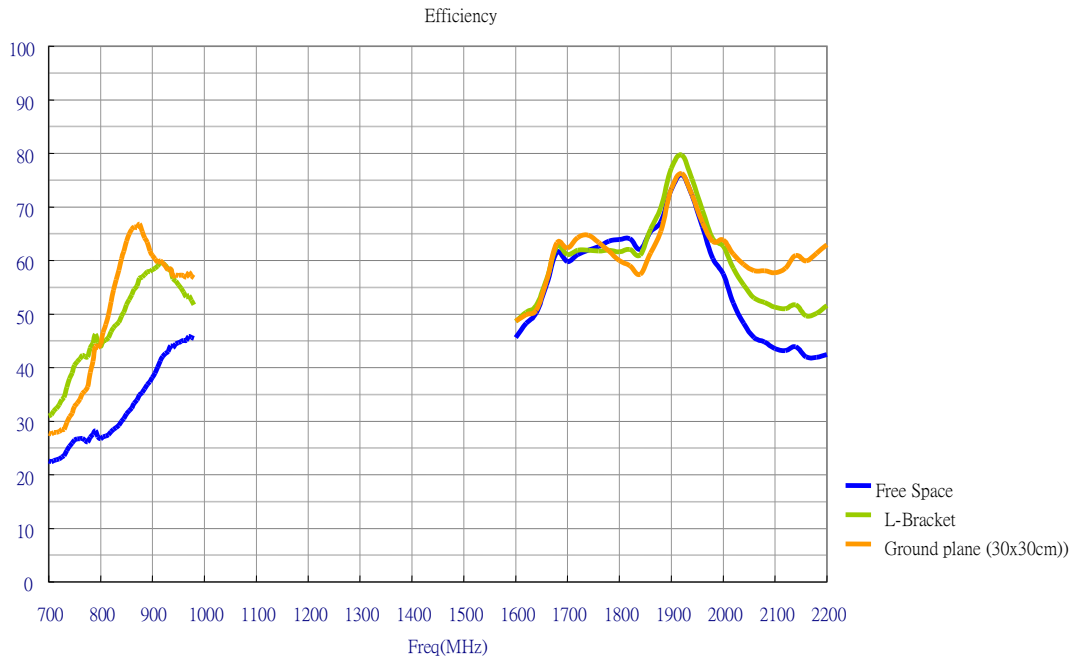

2.3. Peak Gain

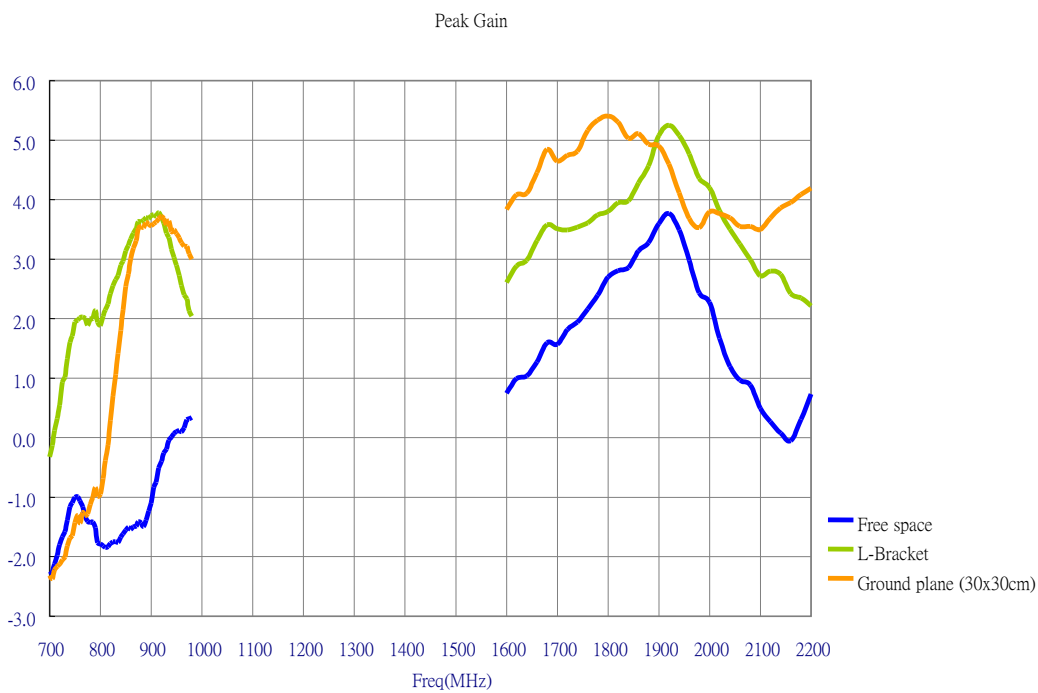

3. Antenna Radiation Pattern

3.1. Antenna Stand Alone

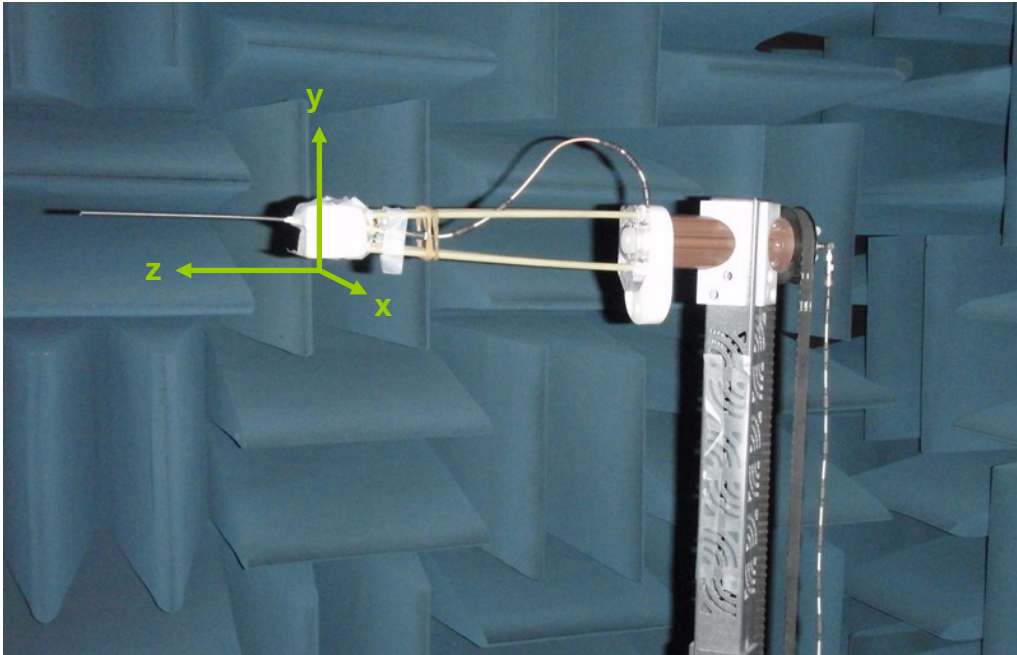

XY-plane

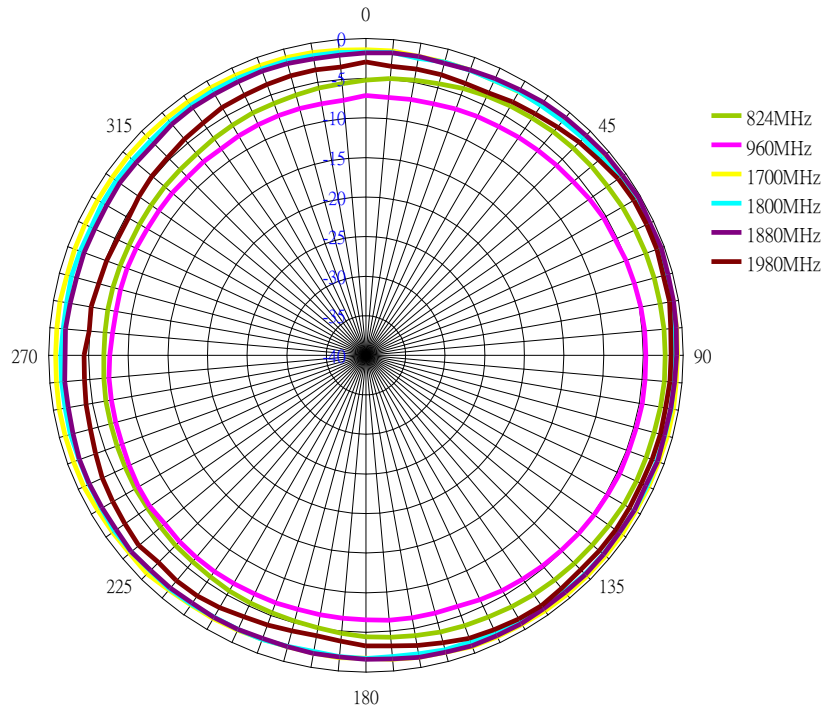

XZ-plane

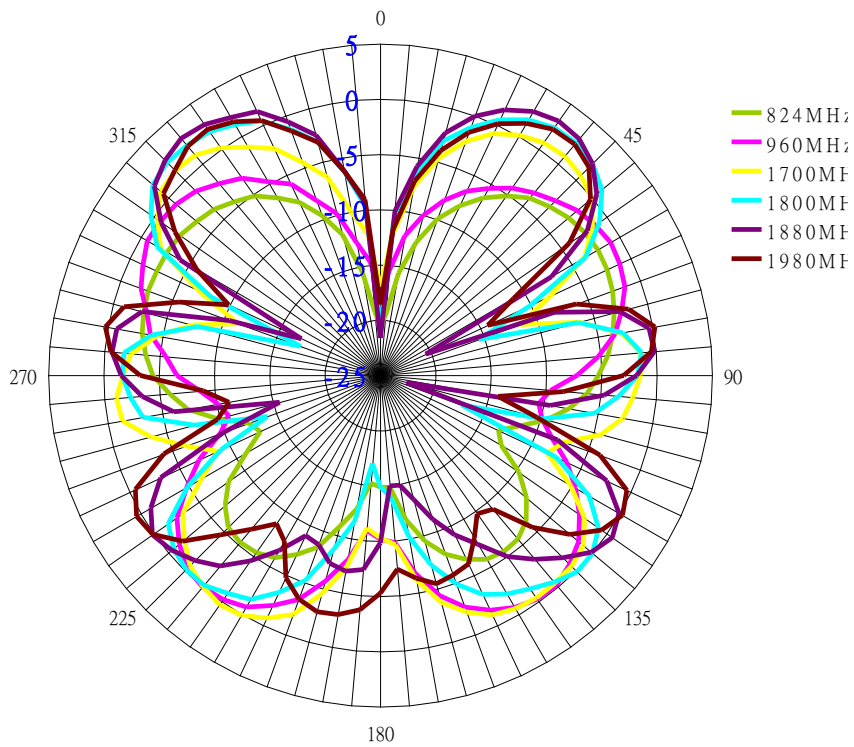

3.2. Antenna with Ground plane (30X30cm)

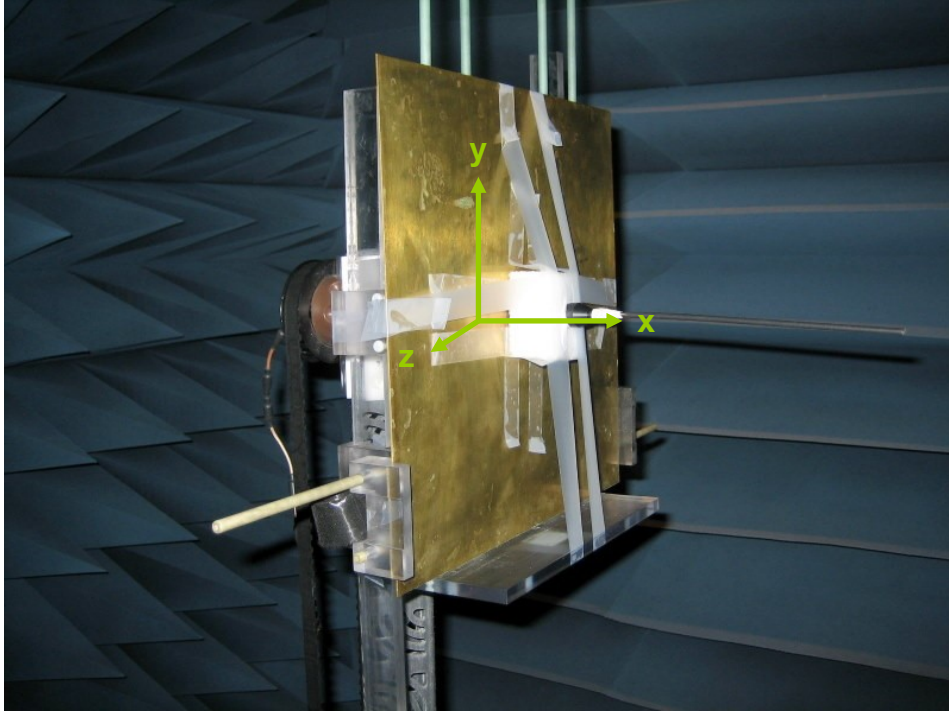

XY-plane

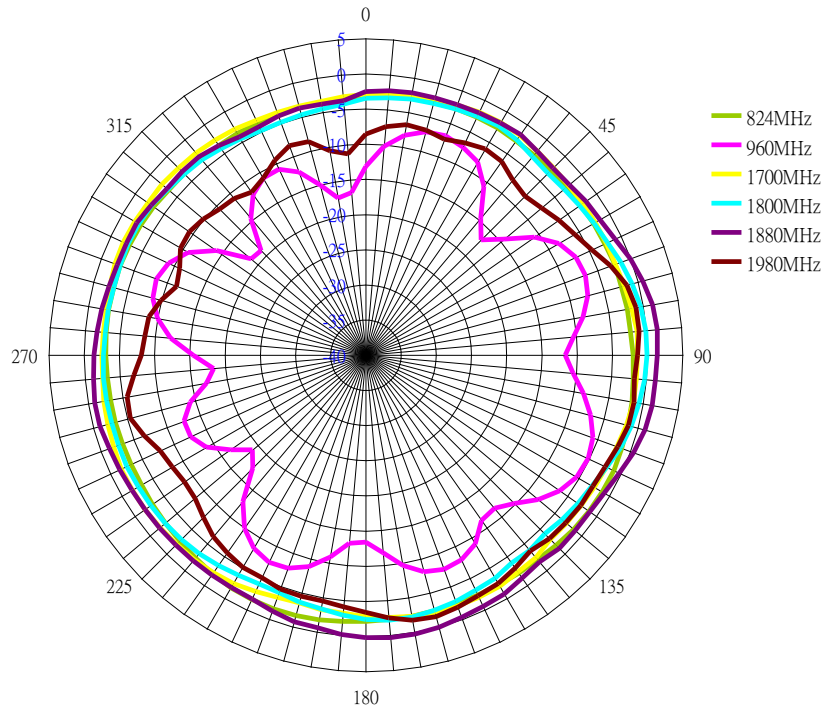

XZ-plane

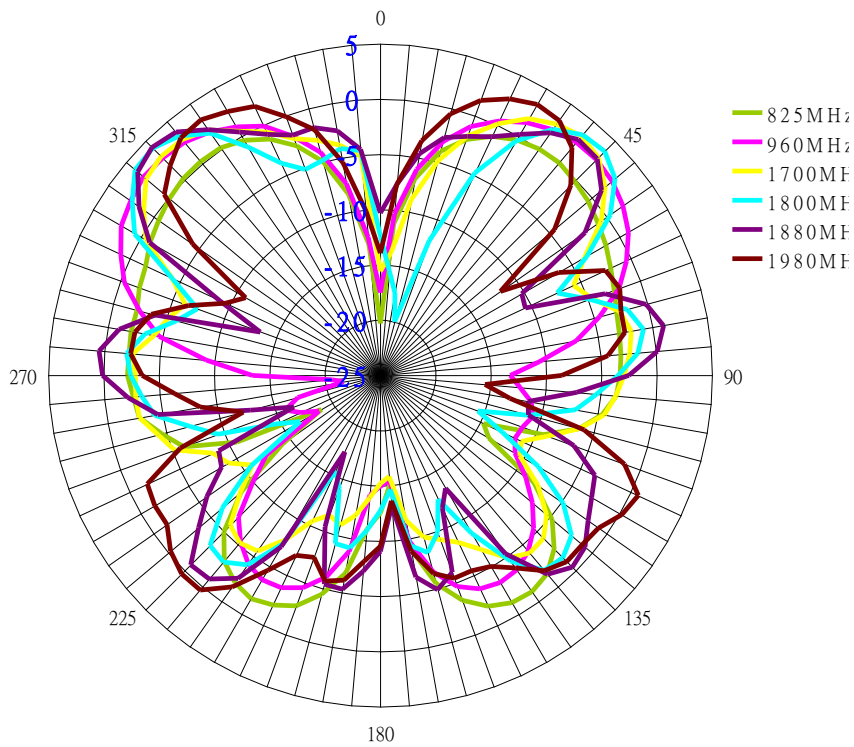

3.3. Antenna with L-Bracket

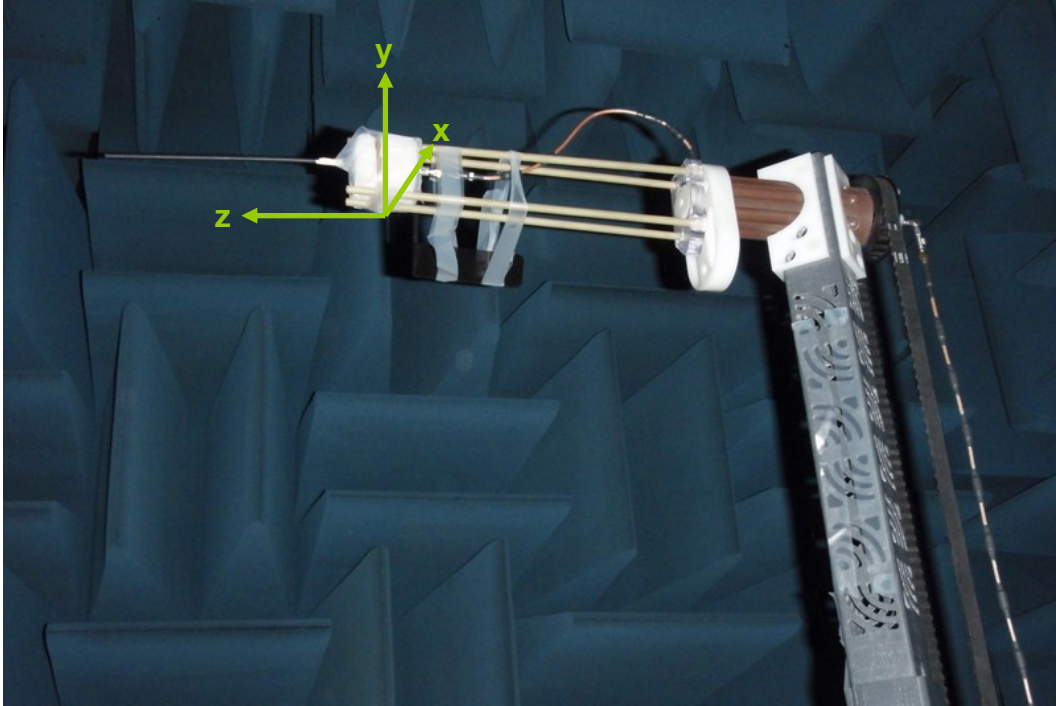

XY-plane

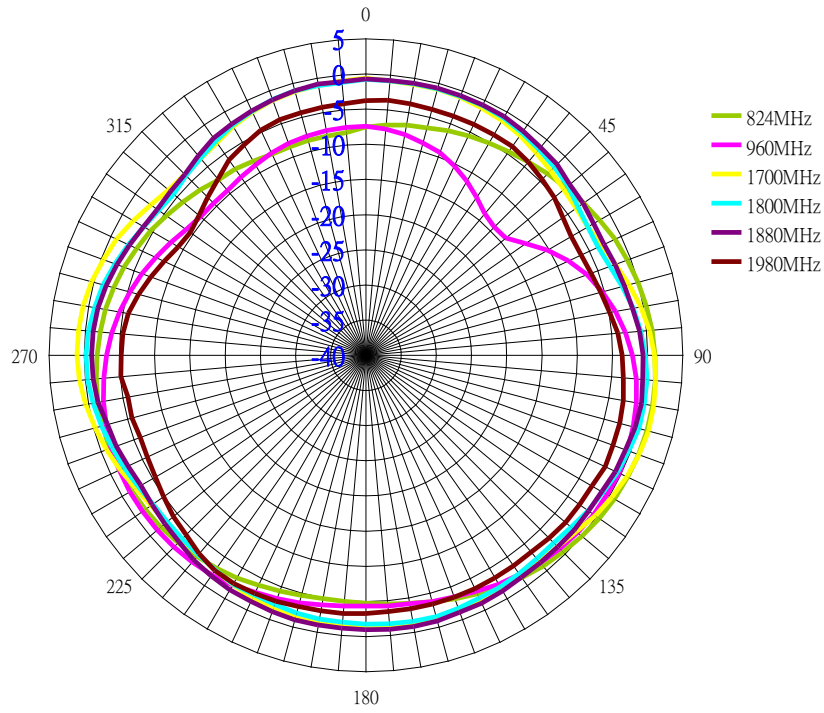

XZ-plane

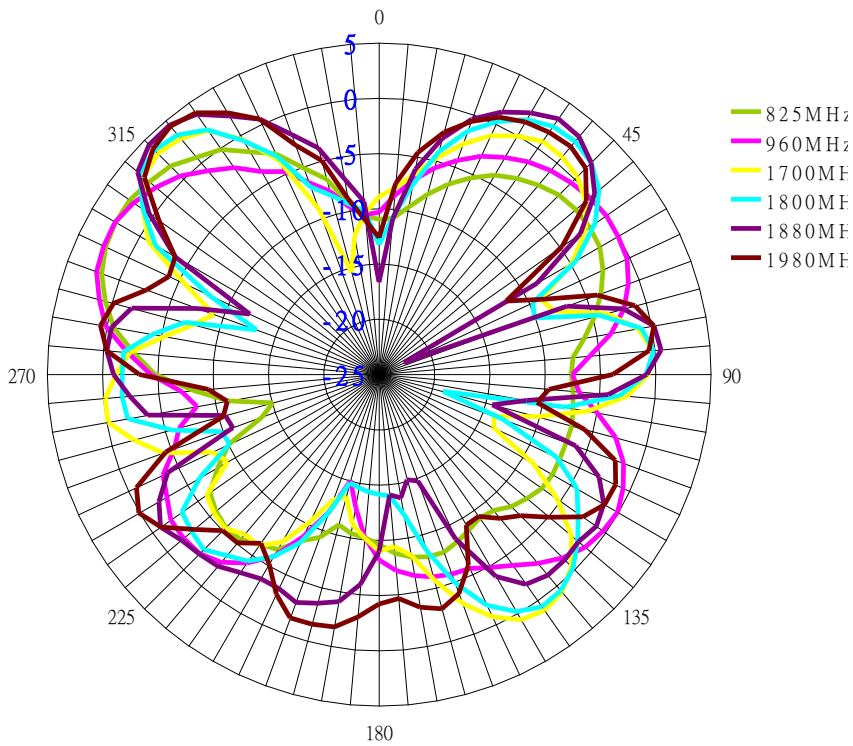

4. Antenna Drawing

Unit : mm

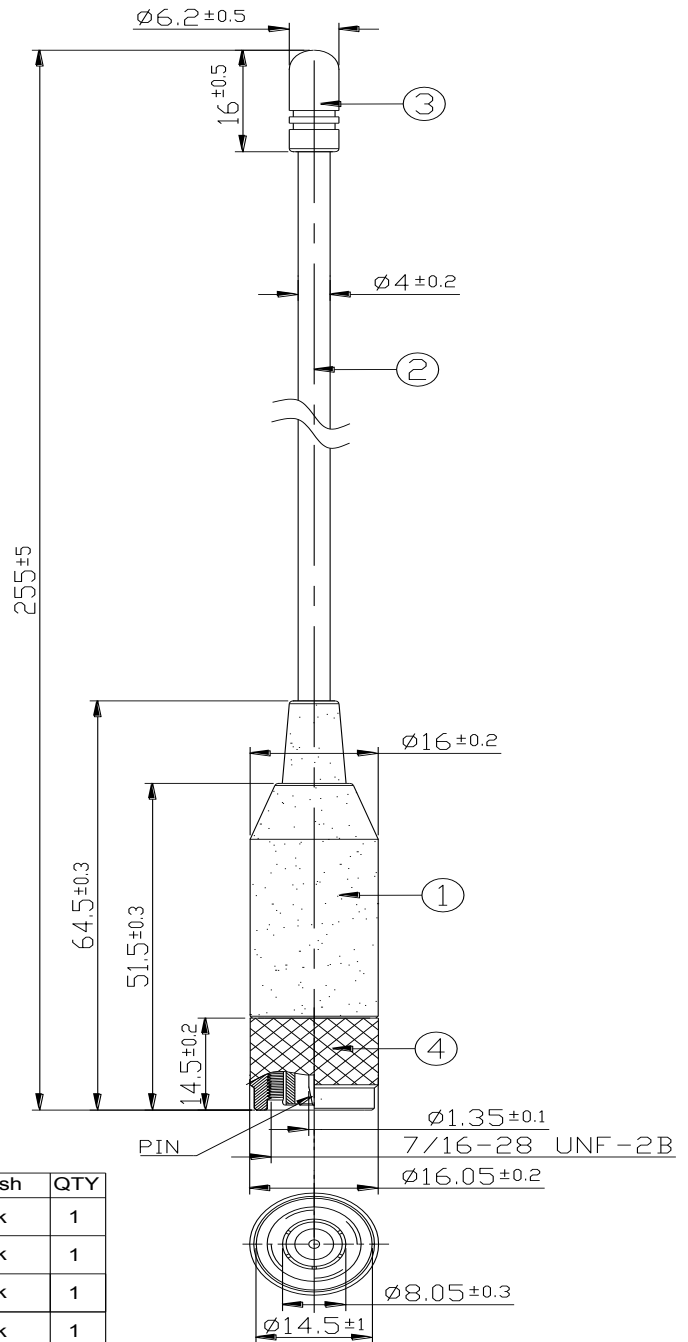

| | Name | Material | Finish | QTY |
|---|----------------------|-----------------|--------|-----|
| 1 | Housing | ABS | Black | 1 |
| 2 | Internal Steel Cable | Steel+PE Jacket | Black | 1 |
| 3 | CAP | ABS | Black | 1 |
| 4 | Outer Body TNC (M) | Brass | Black | 1 |

5. Packaging

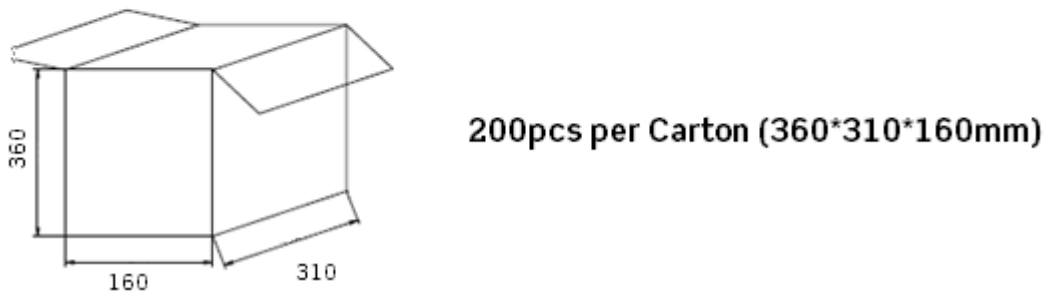
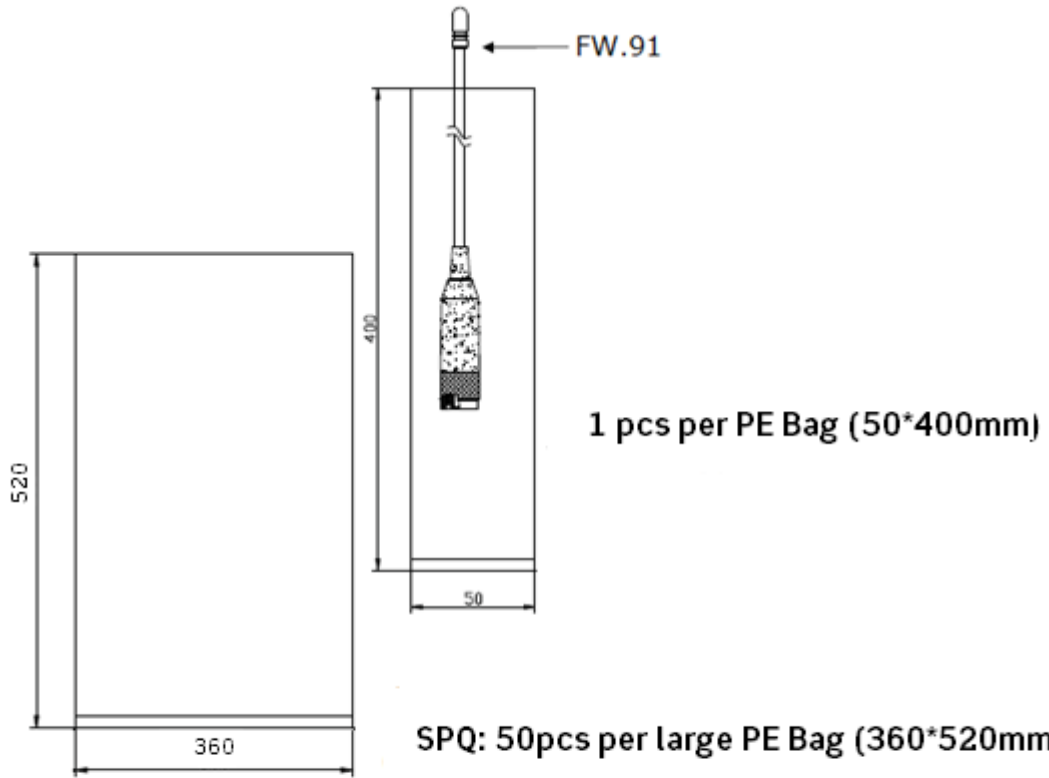



Taoglas makes no warranties based on the accuracy or completeness of the contents of this document and reserves the right to make changes to specifications and product descriptions at any time without notice.

Taoglas reserves the rights to this document and the information contained herein. Reproduction, use or disclosure to third parties without express permission is strictly prohibited.

Copyright © Taoglas Ltd.