

NCP1083WIRGEVB

Compact, High Efficiency, 30 W Reference Platform, Supporting Wide Auxiliary Input Voltage, with the NCP1083 Evaluation Board User's Manual



ON Semiconductor®

<http://onsemi.com>

EVAL BOARD USER'S MANUAL

Board Details

The NCP1083WIRGEVB implements a PoE module DC/DC converter that converts the higher voltage one the Ethernet cable to a lower voltage (12 V) with power levels up to 30 W. Detection, classification and power up sequence is implemented according to IEEE802.3at (D4). The board also supports getting its power from an auxiliary input, in case PoE network is not available. Auxiliary input voltage may be as low as 9 V. The isolated flyback DC/DC converter design is optimized to support a very wide input voltage range (9 V to 57 V) without compromising the overall efficiency.

Warnings

Close to the switching MOSFET voltages on the board may exceed 200 V (@250 kHz). Temperature of board and its components may exceed 85°C during normal operation. The Evaluation board was designed to operate correctly under these conditions.

The input voltage should never exceed 57 V nor should the evaluation board be loaded for long duration with loads higher than the specified 30 W. Exceeding the specified input and output values could permanently damage the board.

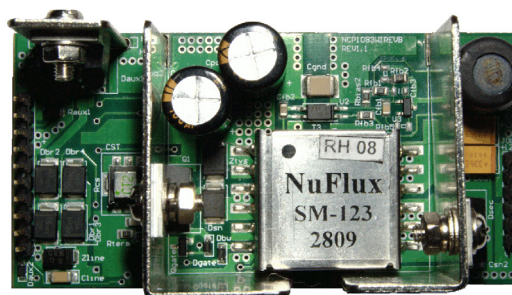

Figure 1. Front Side of EVB

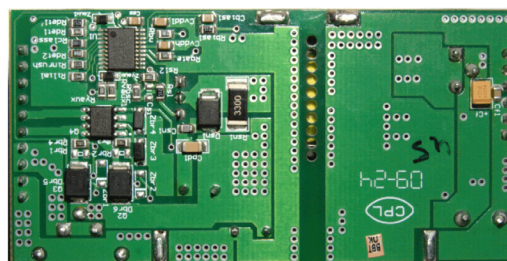

Figure 2. Back Side of EVB

Table 1. EVALUATION BOARD SPECIFICATIONS

Characteristic	Min	Typ	Max	Unit
Input Voltage, PoE Input	36	–	57	V
Input Voltage, Auxiliary Input	9	–	57	V
Output Voltage	–	12	–	V
Output Current	–	–	2.5	A
Oscillator Frequency	–	250	–	kHz
Output Ripple	–	–	170	mV
Efficiency	–	–	86	%

NCP1083WIRGEVB

Table 2. BOARD CONNECTOR DESCRIPTION

Connector	Pin	Description	
P1	1	nClassAT, notification towards external processor that IEEE802.3at, 2 nd event classification has completed	
	2	Not Connected	
	3	V _{IN} , PoE, Pair 1	
	4	V _{IN} , PoE, Pair 1	
	5	V _{IN} , PoE, Pair 2, High Efficiency Input Rectifier	
	6	V _{IN} , PoE, Pair 2, High Efficiency Input Rectifier	
	7, 8	V _{AUX} , Positive Auxiliary Input Supply	
	9, 10	V _{AUX_GND} , Auxiliary Input Supply Ground	
	J _{OUT}	1	12 V Regulated Output
		2	12 V Regulated Output
3		12 V Regulated Output	
4		GND Regulated Output	
5		GND Regulated Output	
6		GND Regulated Output	

Powering Up and Testing the PoE DC/DC Converter

1. Connect a load to the output connector Jout (1, 2, 3) is +12 V and Jout (4, 5, 6) is ground. The load may range from 0 to 30 W.
2. When using the Power over Ethernet input, connect a lab supply or IEEE802.3at compliant PSE equipment to one of the power over Ethernet inputs pair connections:
 - ◆ Between connector P1, pin 3 and 4 for regular efficiency (polarity can be chosen freely).
 - ◆ Between connector P1, pin 5 and 6 for increased efficiency (polarity can be chosen freely).
3. When using the auxiliary input, connect a lab supply (or any other available DC source) to connector P1, pin 7, 8 for the positive node and pin 9, 10 for ground.
4. The DC/DC converter shall start working as soon as detection and classification is completed in PoE powered mode or as soon as power is applied on the auxiliary input.
5. Measure the output voltage to be 12 V and that ripple or noise on the output is within the specification.
6. DC/DC converter stability can be briefly checked by switching on and of repeatedly the load and monitor the voltage transients on an oscilloscope (there should be no oscillation on the output voltage).

NOTES:

1. Only apply power to either one of the PoE input pairs or the auxiliary input supply, not at 2 or 3 inputs at the same time (although this should not result in damage to the board).
2. The heat sinks on the board are dimensioned to cope with the extreme input currents when the lowest auxiliary input voltage of 9 V is used.
3. The auxiliary input supply circuitry was designed to operate from 9 V. Although the board supports higher auxiliary input voltages (up to 57 V), it is advisable to tune the Raux1...3 resistors when higher input voltages are used for long duration in order not to generate excess heat in the clamping diodes Zaux1, 2. (see NCP1082-3 PoE Auxiliary Supply Applications.pdf)

NCP1083WIRGEVB

LAYOUT AND SCHEMATIC

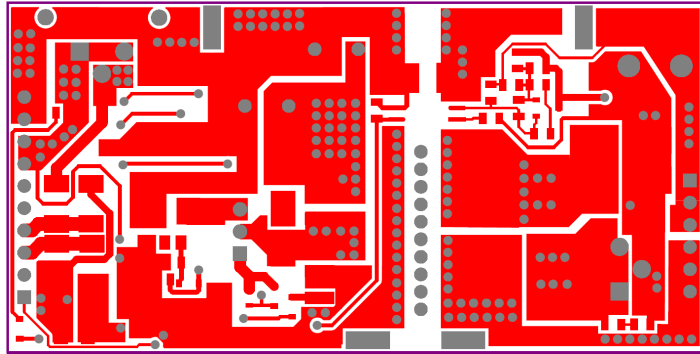

Figure 3. Layout Front

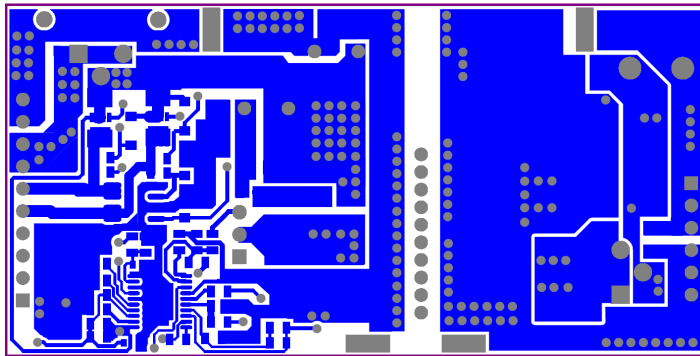

Figure 4. Layout Back

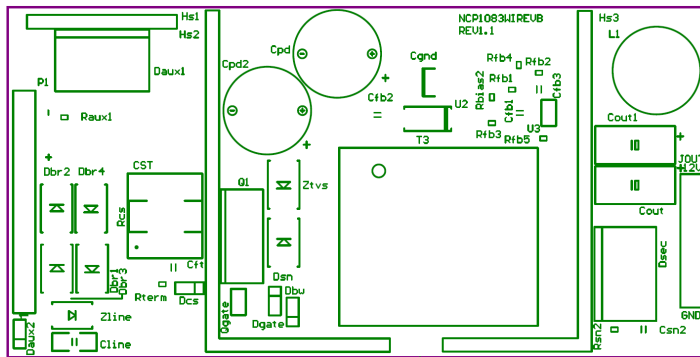

Figure 5. Silkscreen Front

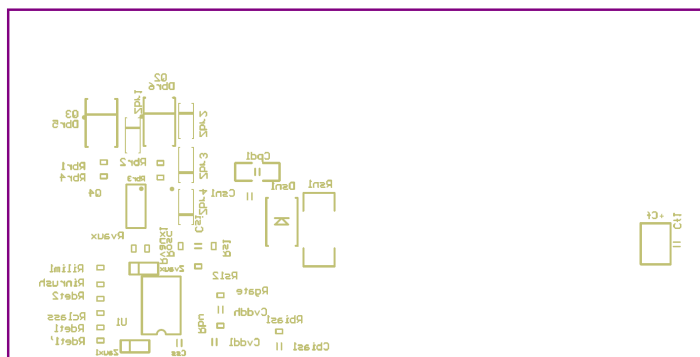

Figure 6. Silkscreen Back

NCP1083WIRGEVB

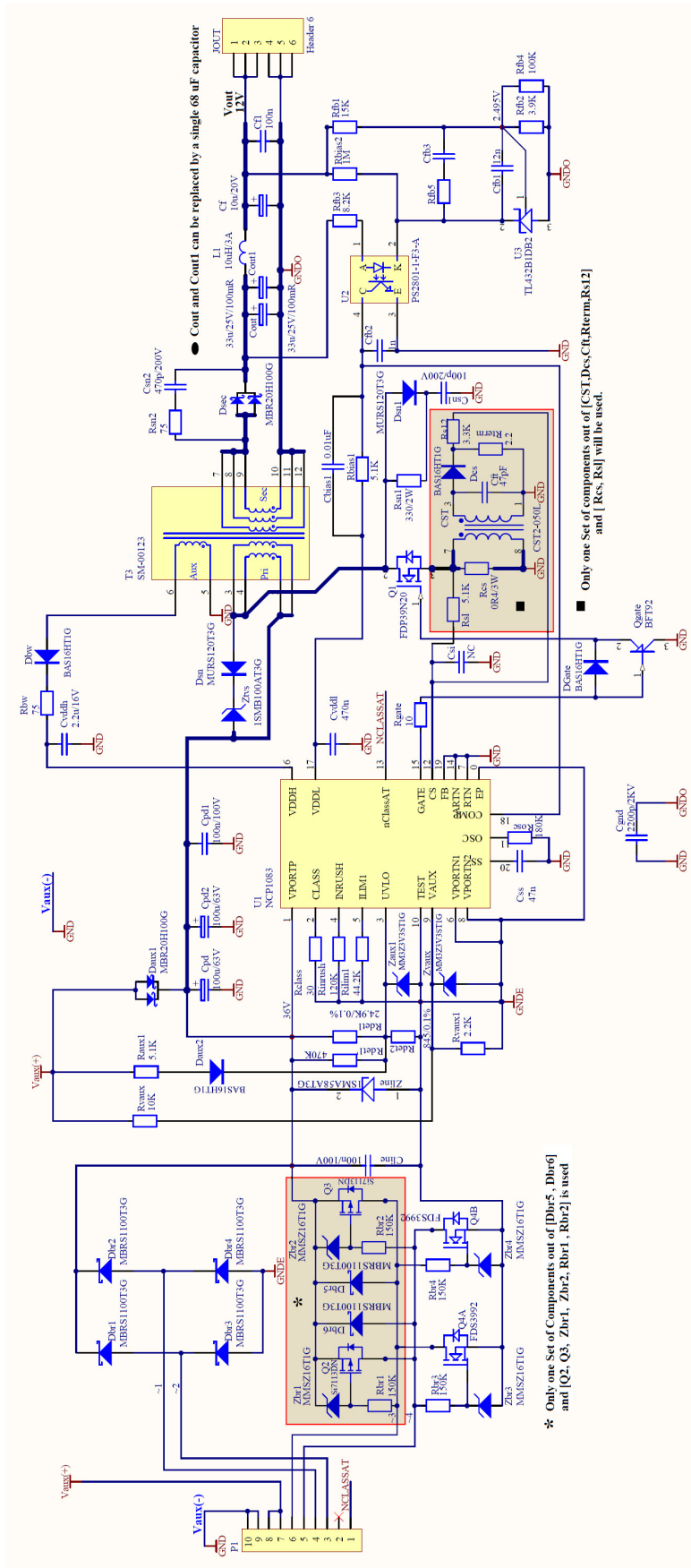

Figure 7. Schematic

NCP1083WIRGEVB

Table 3. Bill of Materials

Designator	Qty	Description	Value	Tolerance	Footprint	Manufacturer	Manufacturer Part Number	Substitution Allowed	Pb Free	NC
U1	1	Power over Ethernet controller	NCP1083		TSSOPEP20	ON Semiconductor	NCP1083DEG	No	Yes	
Cbias1, Cf1	2	Capacitor SMD	100 nF/50 V	10%	0805-C-S	Walsin	0805B103K500CT	Yes	Yes	
Cline, Cpd1	2	Capacitor SMD	100 nF/100 V	10%	1206-C	AVX	12061C104KAT2A	Yes	Yes	
Csn1	1	Capacitor SMD	100 pF/200 V	10%	0805-C-S	AVX	08052A101JAT2A	Yes	Yes	
Cfb1	1	Capacitor SMD	12 nF/50 V	10%	0805-C-S	AVX	08055C123KAT2A	Yes	Yes	
Cfb2	1	Capacitor SMD	1 nF/50 V	10%	0805-C-S	Walsin	0805B102K500CT	Yes	Yes	
Cvddh	1	Capacitor SMD	2.2 μ F/16 V	(+80%) to (-20%)	0805-C-S	AVX	0805YC225MAT2A	Yes	Yes	
Cgnd	1	Capacitor SMD	2200 pF/2 kV	10%	1812	Walsin	1812B222K202LT	Yes	Yes	
Cvddl	1	Capacitor SMD	470 nF/50 V	10%	0805-C-S	AVX	08055C474KAZ2A	No	Yes	
Csn2	1	Capacitor SMD	470 pF/200 V	10%	0805-C-S	AVX	08052C47KJAT2A	Yes	Yes	
Css	1	Capacitor SMD	47 nF/50 V	10%	0805-C-S	AVX	08055C473KAT2A	Yes	Yes	
Cft	1	Capacitor SMD	47 pF/50 V	10%	0805-C-S	Walsin	0805N470J500LT	Yes	Yes	
Cpd2, Cpd	2	Electrolytic Capacitor	100 μ F/63 V	(+20%) to (-20%)	CRD10.0L17.0R M5.0	Hitano	EXR101M63	No	Yes	
Cf	1	Capacitor Polar	10 μ F/20 V	10%	C-TANT-B	AVX	TAJB106K020R	Yes	Yes	
Cout, Cout1	2	Capacitor Polar	33 μ /25 V/ 100 mR	10%	C-TANT-E	AVX	TPSD336K025R0100	No	Yes	
T3	1	PoE Plus Transformer	SM-00123		EFD20	NUFLUX	SM-00123	No	Yes	
Daux2, Dcs, Dbw, Dgate	4	SMD Switching Diode	BAS16HT1G		SOD323	ON Semiconductor	BAS16HT1G	Yes	Yes	
Daux1, Dsec	2	Schottky Rectifier	MBR20H100CTG		TO-220AB	ON Semiconductor	MBR20H100CTG	No	Yes	
Dsn, Dsn1	2	SMD Ultrafast Rectifiers	MURS120T3G		403A-03	ON Semiconductor	MURS120T3G	No	Yes	
Dbr1, Dbr2, Dbr3, Dbr4, Dbr5, Dbr6	6	SMD Schottky Rectifier	MBRS1100T3G		403A-03	ON Semiconductor	MBRS1100T3G	No	Yes	
Zline	1	SMD TVS Zener	1SMA58AT3G		SMA	ON Semiconductor/ Multicomp	1SMA58AT3G/ SMAJ58A	Yes	Yes	
Ztvs	1	SMD TVS Zener	1SMB100AT3G		403A-03	ON Semiconductor/ Multicomp	1SMB100AT3G/ SMAJ58A	Yes	Yes	
Zaux1, Zvaux	2	SMD Zener	MM3Z3V3ST1G		SOD323	ON Semiconductor	MM3Z3V3ST1G	Yes	Yes	
Zbr3, Zbr4	2	SMD Zener	MMSZ16T1G		SOD123	ON Semiconductor	MMSZ16T1G	Yes	Yes	
JOUT	1	Header, 6-Pin	Header 6		HDR1X6	FCI	8614-00-36-1-Y0-10	Yes	Yes	
P1	1	Header, 10-Pin	Header 10		HDR1X10	FCI	8614-00-36-1-Y0-10	Yes	Yes	
L1	1	Drum Core Choke	10 μ H/3 A		10X12	Prismatic	9404037403	No	Yes	
Q1	1	MOSFET N-Channel	FDP39N20		TO-220-AB	Fairchild	FDP39N20	No	Yes	
Q4	1	MOSFET N-Channel	FDS3992		SO-8	Fairchild	FDS3992	No	Yes	
Qgate	1	Transistor PNP	BFT92		SOT23	Philips	BFT92	Yes	Yes	

NCP1083WIRGEVB

Designator	Qty	Description	Value	Tolerance	Footprint	Manufacturer	Manufacturer Part Number	Substitution Allowed	Pb Free	NC
U2	1	High Isolation Voltage SSOP Photocoupler	PS2801-1-F3-A		SSOP4	CEL	PS2801-1	No	Yes	
U3	1	Programmable Shunt Voltage Reference	TL432BIDBZTG4		SOT23	Texas-Instruments	TL432BIDBZTG4	No	Yes	
Rgate	1	Resistor SMD	10 Ω		0805-R-S	Walsin	WR08X10R0FTL	Yes	Yes	
Rfb4	1	Resistor SMD	100 kΩ	1%	0805-R-S	Walsin	WR08X1003FTL	Yes	Yes	
Rvaux	1	Resistor SMD	10 kΩ	1%	0805-R-S	Walsin	WR08X1002FTL	Yes	Yes	
Rinrush	1	Resistor SMD	121 kΩ	1%	0805-R-S	Walsin	WR08X1213FTL	Yes	Yes	
Rbr3, Rbr4	2	Resistor SMD	150 kΩ	1%	0805-R-S	Walsin	WR08X1503FTL	Yes	Yes	
Rfb1	1	Resistor SMD	15 kΩ	1%	0805-R-S	Walsin	WR08X1502FTL	Yes	Yes	
Rosc	1	Resistor SMD	182 kΩ	1%	0805-R-S	Walsin	WR08X1823FTL	Yes	Yes	
Rbias2	1	Resistor SMD	1 MΩ	1%	0805-R-S	Walsin	WR08X1004FTL	Yes	Yes	
Rterm	1	Resistor SMD	2.2 Ω	1%	0805-R-S	Walsin	WR08X2R2JTL	Yes	Yes	
Rvaux1	1	Resistor SMD	2.21 kΩ	1%	0805-R-S	Walsin	WR08X2211FTL	Yes	Yes	
Rdet1	1	Resistor SMD	24.9 kΩ	1%	0805-R-S	Walsin	WR08X2492FTL	Yes	Yes	
Rs12	1	Resistor SMD	3.3 kΩ	1%	0805-R-S	Walsin	WR08X3301FTL	Yes	Yes	
Rfb2	1	Resistor SMD	3.92 kΩ	1%	0805-R-S	Walsin	WR08X3921FTL	Yes	Yes	
Rclass	1	Resistor SMD	30.1 Ω	1%	0805-R-S	Yageo	RC0805FR-0730R1L	Yes	Yes	
Rsn1	1	Resistor SMD	330E/1W	5%	2512-S	Walsin	WR25X331JTL	Yes	Yes	
Rilm1	1	Resistor SMD	44.2 kΩ	1%	0805-R-S	Walsin	WR08X4422FTL	Yes	Yes	
Rdet1	1	Resistor SMD	475 kΩ	1%	0805-R-S	Walsin	WR08X4753FTL	Yes	Yes	
Raux1, Rbias1, Rsl	3	Resistor SMD	5.1 kΩ	5%	0805-R-S	Walsin	WR08X512JTL	Yes	Yes	
Rbw, Rsn2	2	Resistor SMD	75 Ω	1%	0805-R-S	Walsin	WR08X750JTL	Yes	Yes	
Rfb3	1	Resistor SMD	8.25 kΩ	1%	0805-R-S	Walsin	WR08X8251FTL	Yes	Yes	
Rdet2	1	Resistor SMD	845 Ω	1%	0805-R-S	Yageo	RC0805FR-07845RL	Yes	Yes	
CST	1	SMT Current Sensors-CST Series	500 μH		SMD	Coilcraft	CST2-050LB	No	Yes	
HS1	1	A10-220 Type copper heat sink	Custom, see drawing		25 mm X 14.5 mm			Yes	Yes	
HS2	1	L Type Mosfet copper heat sink	Custom, see drawing		25 mm X (38+20) mm			Yes	Yes	
HS3	1	L Type Diode copper heat sink	Custom, see drawing		25 mm X (38+20) mm			Yes	Yes	
	3	Screws	M3 X 10					Yes	Yes	
	6	Plain Washer	M3					Yes	Yes	
	3	Spring Washer	M3					Yes	Yes	
	3	Nut	M3					Yes	Yes	
Cfb3	1	Capacitor	NC		0805-C-S				Yes	NC
Csi	1	Capacitor	NC		0805-C-S				Yes	NC
Zbr1, Zbr2	2	Diode Zener 16 V	MMSZ16T1G		SOD123				Yes	NC
Rcs	1	Resistor	0R4/3W		2512-S				Yes	NC
Rbr1, Rbr2	2	Resistor	150 kΩ		0805-R-S				Yes	NC
Rfb5	1	Resistor	NC		0805-R-S				Yes	NC
Q2, Q3	2	P-Channel 30 V (D-S) MOSFET	Si7113DN		POWERPACK 1212-8				Yes	NC

NOTE: Only one set of components out of (Dbr5, Dbr6) and (Q2, Q3, Zbr1, Zbr2, Rbr1, Rbr2) is used.

NCP1083WIRGEVB

ON Semiconductor and  are registered trademarks of Semiconductor Components Industries, LLC (SCILLC). SCILLC reserves the right to make changes without further notice to any products herein. SCILLC makes no warranty, representation or guarantee regarding the suitability of its products for any particular purpose, nor does SCILLC assume any liability arising out of the application or use of any product or circuit, and specifically disclaims any and all liability, including without limitation special, consequential or incidental damages. "Typical" parameters which may be provided in SCILLC data sheets and/or specifications can and do vary in different applications and actual performance may vary over time. All operating parameters, including "Typicals" must be validated for each customer application by customer's technical experts. SCILLC does not convey any license under its patent rights nor the rights of others. SCILLC products are not designed, intended, or authorized for use as components in systems intended for surgical implant into the body, or other applications intended to support or sustain life, or for any other application in which the failure of the SCILLC product could create a situation where personal injury or death may occur. Should Buyer purchase or use SCILLC products for any such unintended or unauthorized application, Buyer shall indemnify and hold SCILLC and its officers, employees, subsidiaries, affiliates, and distributors harmless against all claims, costs, damages, and expenses, and reasonable attorney fees arising out of, directly or indirectly, any claim of personal injury or death associated with such unintended or unauthorized use, even if such claim alleges that SCILLC was negligent regarding the design or manufacture of the part. SCILLC is an Equal Opportunity/Affirmative Action Employer. This literature is subject to all applicable copyright laws and is not for resale in any manner.

PUBLICATION ORDERING INFORMATION

LITERATURE FULFILLMENT:

Literature Distribution Center for ON Semiconductor
P.O. Box 5163, Denver, Colorado 80217 USA
Phone: 303-675-2175 or 800-344-3860 Toll Free USA/Canada
Fax: 303-675-2176 or 800-344-3867 Toll Free USA/Canada
Email: orderlit@onsemi.com

N. American Technical Support: 800-282-9855 Toll Free
USA/Canada
Europe, Middle East and Africa Technical Support:
Phone: 421 33 790 2910
Japan Customer Focus Center
Phone: 81-3-5817-1050

ON Semiconductor Website: www.onsemi.com
Order Literature: <http://www.onsemi.com/orderlit>
For additional information, please contact your local
Sales Representative