



MODEL: SP-1609S
PRODUCT: Dynamic Speaker
EDITION: A/2016

THIS SPECIFICATION COVERS OUR PRODUCT OF DYNAMIC SPEAKER UNIT FOR MOBILE PHONE USE

SPEAKER ELECTROACOUSTIC CHARACTERISTICS

sound pressure level	92±3dB Spl @ 2KHZ 1.0V(Sine wave) 0.1m measured with baffle shown in Fig.1. (1CC BOX)
resonance frequency (FO)	850±20%Hz @ 1Vrms. (In 1CC BOX)
measuring diagram	Shown in Fig.1
typical frequency response curve	Shown in Fig.2.
rated noise power	0.7W (In 1CC Box)
short-term max. power	1.0W (In 1CC Box)
distortion	Less than 10% at 1KHz 1V
operation test	Must be free of audible noise (buzzes and rattles) (200 ~ 5000Hz frequency range, input level up to 2.0Vrms (In 1CC BOX))

GENERAL SPECIFICATIONS

operating temperature range	-25°C ~ +65°C
storage temperature range	-40°C ~ +85°C
ac impedance	8.0Ω±15% (@2KHz 1Vrms)
dimension	16 x 9 x 4.3 mm

TYPICAL FREQUENCY RESPONSE CURVE

FREQUENCY MEASURING CIRCUIT (SPEAKER MODE) (Fig.1)

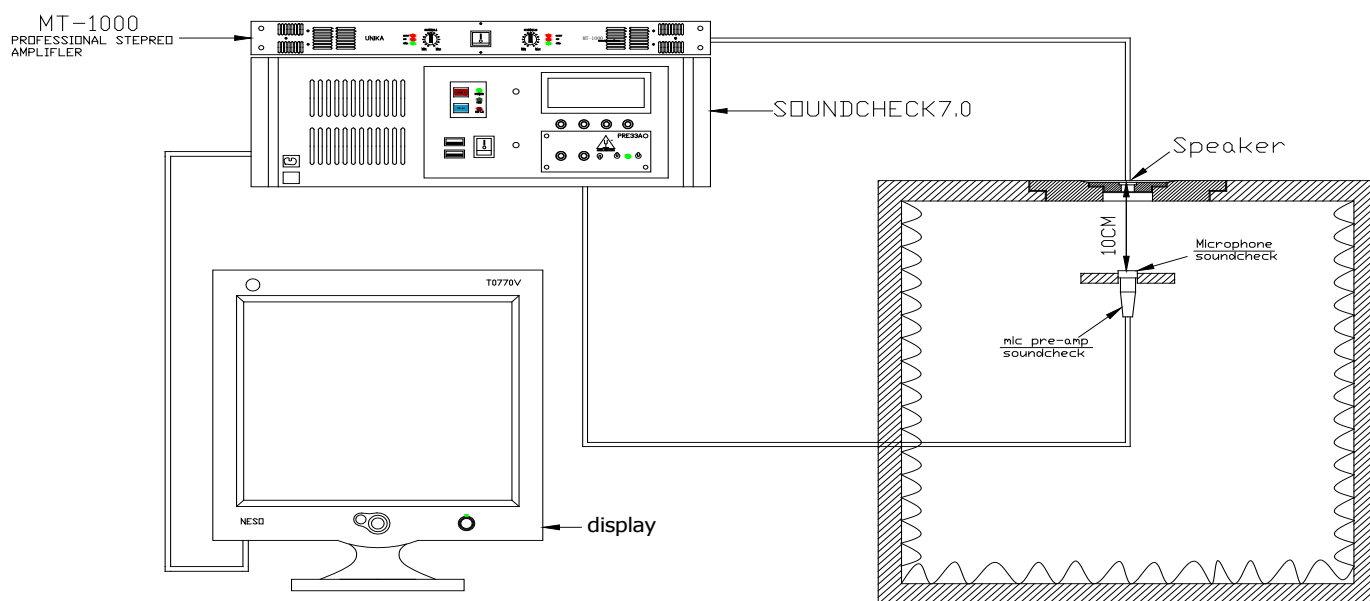

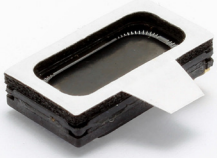

MODEL: SP-1609S
PRODUCT: Dynamic Speaker
EDITION: A/2016

Soberton Inc.

TYPICAL FREQUENCY RESPONSE CURVE (Continued)

TYPICAL FREQUENCY RESPONSE CURVE (SPEAKER MODE) (Fig.2)

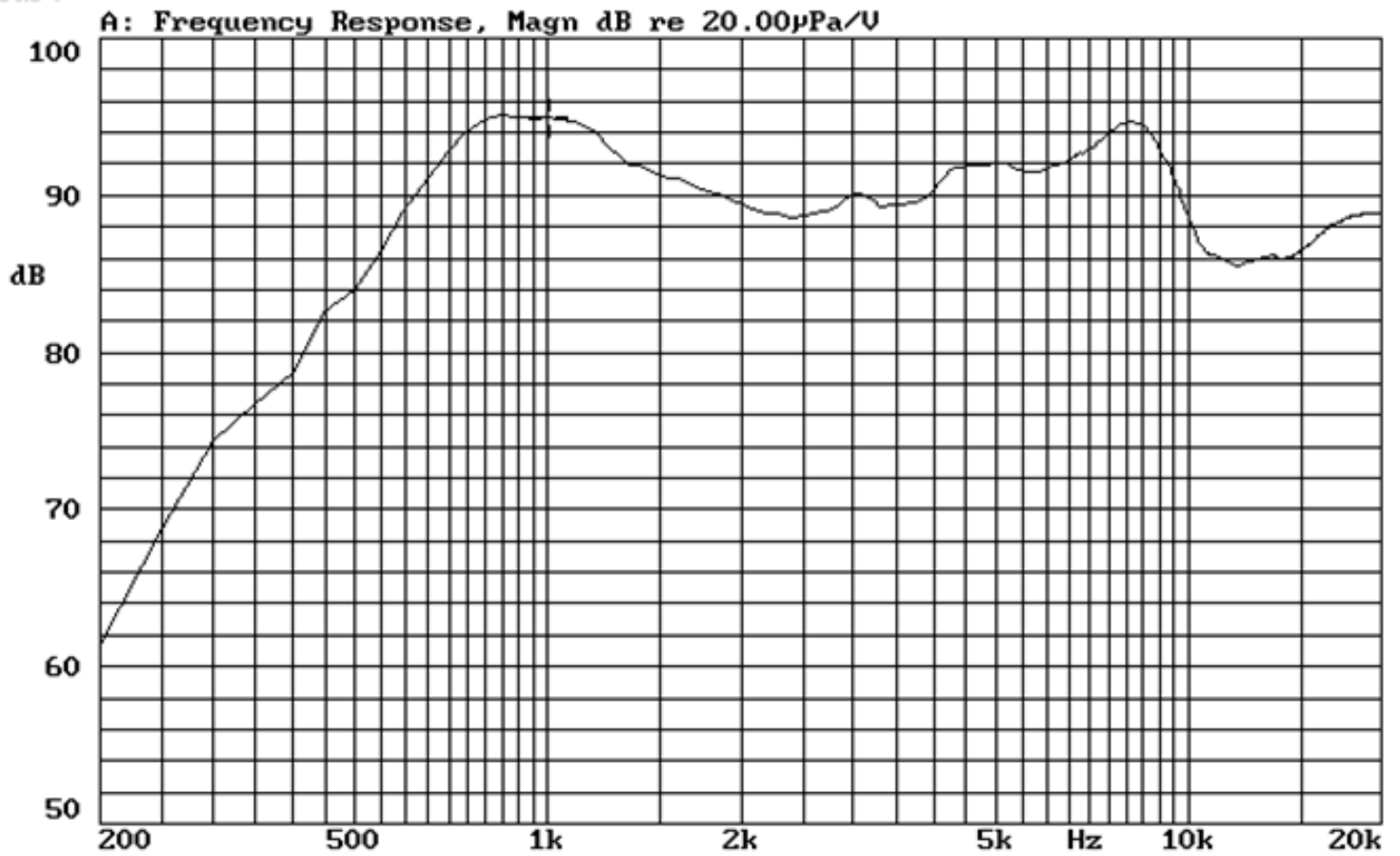

TEST CLIMATIC CONDITIONS

STANDARD TEST CONDITIONS

temperature	17~25°C
relative humidity	45%~80%(RH)
air pressure	860~1060 hPa



MODEL: SP-1609S
PRODUCT: Dynamic Speaker
EDITION: A/2016

RELIABILITY TESTS

The sound pressure as specified shall neither deviate more than $\pm 3\text{dB}$ from the initial value, nor have any significant damage after any of following testing.

HIGH TEMPERATURE TEST

high temperature	$+85\pm 2^{\circ}\text{C}$
duration	96 hours

LOW TEMPERATURE TEST

low temperature	$-40\pm 2^{\circ}\text{C}$
duration	96 hours

HEAT SHOCK TEST (See in Fig.3)

high temperature	$+85\pm 2^{\circ}\text{C}$
low temperature	$-40\pm 2^{\circ}\text{C}$
duration	1 hour (high), 1 hour (low)
changeover time	< 20 seconds
cycle	10

HUMIDITY TEST

temperature	$+40\pm 2^{\circ}\text{C}$
relative humidity	90~95%
duration	96 hours

TEMPERATURE CYCLE TEST (See in Fig.4)

temperature	-40°C $+85^{\circ}\text{C}$
duration	45 minutes 45 minutes
temperature gradient	1~3 $^{\circ}\text{C}/\text{min}$.
cycle	10

DROP TEST

mounted with dummy set mass	100 g
height	1.5 m
cycle	6 (1 each plain) onto the concrete board

LOAD TEST

noise signal	White noise (EIA filter)
input power	0.7 W (1CC BOX) (2.37Vrms)
duration	96 hours



MODEL: SP-1609S
PRODUCT: Dynamic Speaker
EDITION: A/2016

TEST METHOD

HEAT SHOCK TEST (Fig.3)

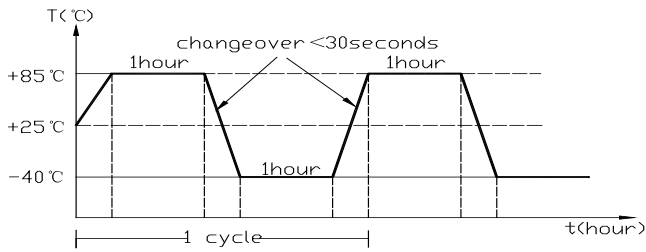

TEMP. CYCLE TEST (Fig.4)

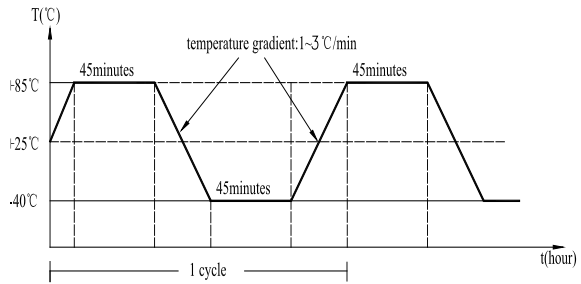

PRODUCT EXTERNAL VIEW AND DIMENSIONS (Fig.5)

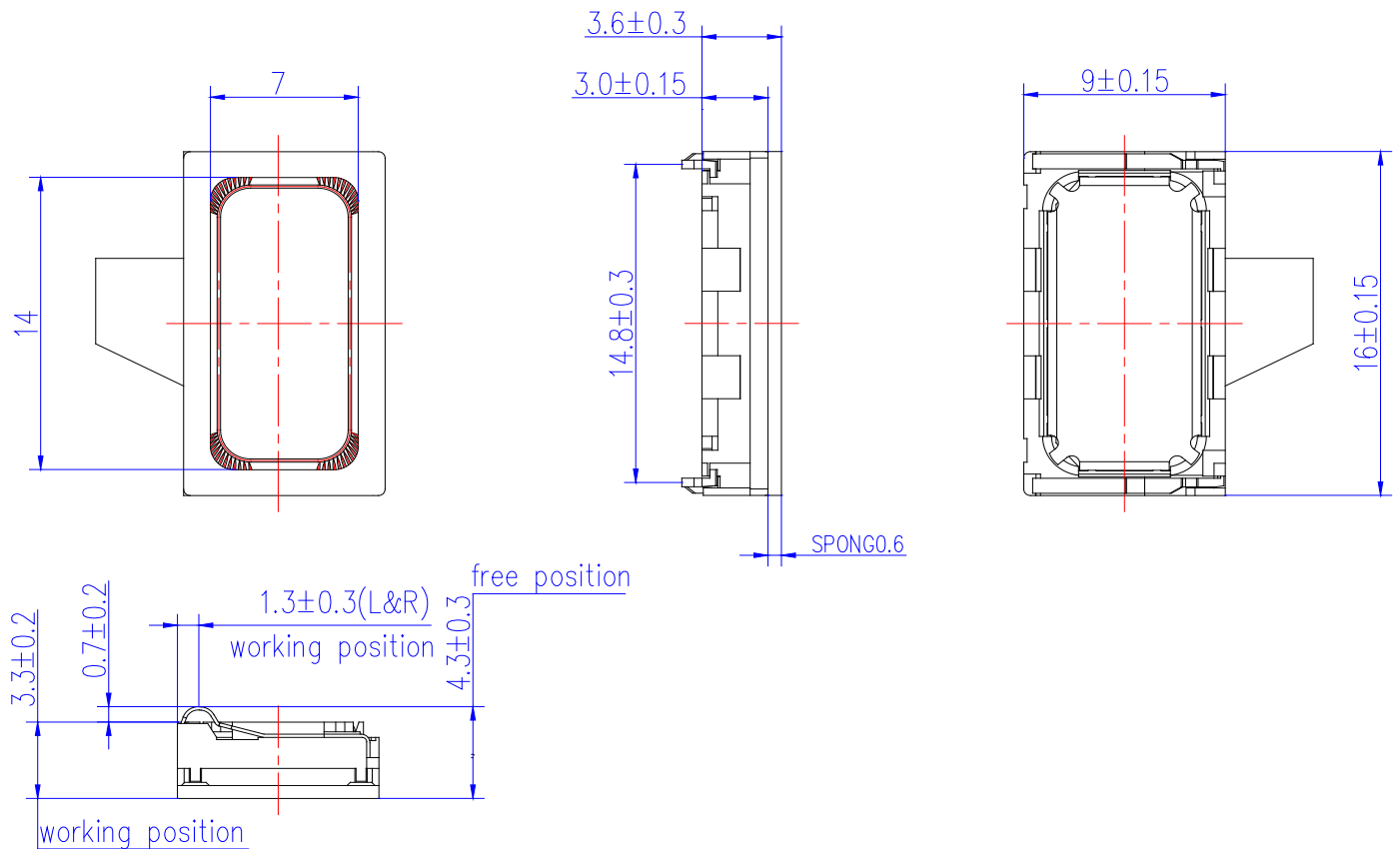

no	item	material	quantity
1	Magnet	Nd-Fe-B	1
2	U-Yoke	Iron	1
3	Pole Piece	Iron	1
4	Voice coil	Copper	1
5	Frame	PPA	1
6	Gasket	PE	1

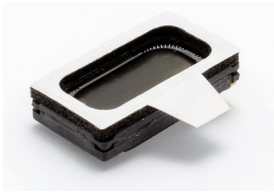

MODEL: SP-1609S
PRODUCT: Dynamic Speaker
EDITION: A/2016

Soberton Inc.

PACKING

