

1N648-1

FEATURES

- 1N648-1
- SILICON RECTIFIER
- METALLURGICALLY BONDED
- HERMETICALLY SEALED
- DOUBLE PLUG CONSTRUCTION

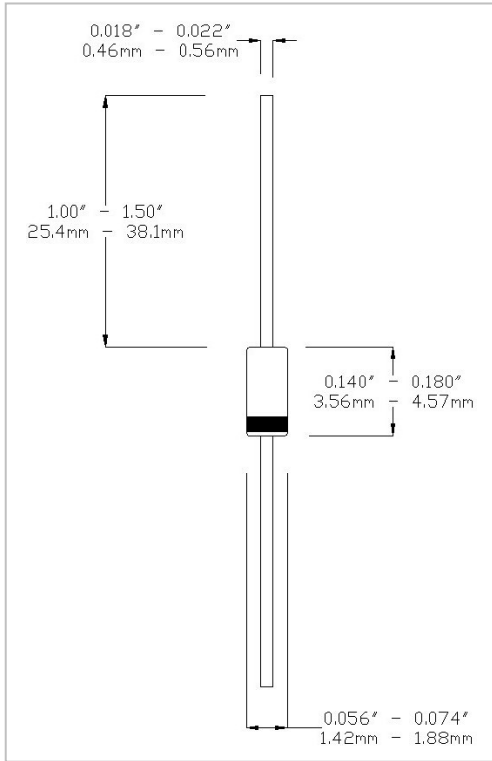

MAXIMUM RATINGS AT 25 °C

Operating Temperature:	-65°C to +175°C
Storage Temperature:	-65°C to +175°C
Surge Current A, sine 8.3ms:	5.0A
Total Power Dissipation:	500mW
Operating Current:	400mA, T _A = +25°C
Operating Current:	150mA, T _A = +150°C
Derating Factor:	2mA/°C above +25°C
Derating Factor:	6mA/°C above +150°C
D.C. Reverse Voltage (VRWM):	500V

DC ELECTRICAL CHARACTERISTICS

V _F				I _R			
Ambient (°C)	I _F mA	Min V	Max V	Ambient (°C)	V _R V (dc)	Min μA	Max μA
25	400	0.80	1.00	25	500	-	0.050
				25	600	-	50

DESIGN DATA

Case: Hermetically sealed glass package

Lead Material: Copper clad steel

Lead Finish: Tin/Lead

Marking: Blue body coat, Black digits.

Polarity: Cathode end is banded.

AC ELECTRICAL CHARACTERISTICS AT 25°C

	Symbol	Min	Max
Capacitance @ V _R = 4V	pF	-	20



WWW.MICROSEMI.COM

IRELAND - GORT ROAD, ENNIS, CO. CLARE

PHONE: +353 65 6840044
TOLL FREE: +186 62 702434
FAX: +353 65 6822298

U.S.A. DOMESTIC SALES CONTACT

PHONE: (617) 926 0404
TOLL FREE: 1 800 666 2999