

Important notice

Dear Customer,

On 7 February 2017 the former NXP Standard Product business became a new company with the tradename **Nexperia**. Nexperia is an industry leading supplier of Discrete, Logic and PowerMOS semiconductors with its focus on the automotive, industrial, computing, consumer and wearable application markets

In data sheets and application notes which still contain NXP or Philips Semiconductors references, use the references to Nexperia, as shown below.

Instead of <http://www.nxp.com>, <http://www.philips.com/> or <http://www.semiconductors.philips.com/>, use <http://www.nexperia.com>

Instead of sales.addresses@www.nxp.com or sales.addresses@www.semiconductors.philips.com, use salesaddresses@nexperia.com (email)

Replace the copyright notice at the bottom of each page or elsewhere in the document, depending on the version, as shown below:

- © NXP N.V. (year). All rights reserved or © Koninklijke Philips Electronics N.V. (year). All rights reserved

Should be replaced with:

- © **Nexperia B.V. (year). All rights reserved.**

If you have any questions related to the data sheet, please contact our nearest sales office via e-mail or telephone (details via salesaddresses@nexperia.com). Thank you for your cooperation and understanding,

Kind regards,

Team Nexperia



BUK7E4R3-75C

N-channel TrenchMOS standard level FET

Rev. 02 — 19 April 2011

Product data sheet

1. Product profile

1.1 General description

Standard level N-channel enhancement mode Field-Effect Transistor (FET) in a plastic package using TrenchMOS technology. This product has been designed and qualified to the appropriate AEC standard for use in automotive critical applications.

1.2 Features and benefits

- AEC Q101 compliant
- Suitable for standard level gate drive sources
- Suitable for thermally demanding environments due to 175 °C rating

1.3 Applications

- 12 V, 24 V and 42 V loads
- Automotive systems
- General purpose power switching
- Motors, lamps and solenoids

1.4 Quick reference data

Table 1. Quick reference data

Symbol	Parameter	Conditions	Min	Typ	Max	Unit
V_{DS}	drain-source voltage	$T_j \geq 25\text{ °C}$; $T_j \leq 175\text{ °C}$	-	-	75	V
I_D	drain current	$V_{GS} = 10\text{ V}$; $T_{mb} = 25\text{ °C}$; see Figure 1 ; see Figure 4	[1][2] -	-	100	A
P_{tot}	total power dissipation	$T_{mb} = 25\text{ °C}$; see Figure 2	-	-	333	W
Static characteristics						
$R_{DS(on)}$	drain-source on-state resistance	$V_{GS} = 10\text{ V}$; $I_D = 25\text{ A}$; $T_j = 25\text{ °C}$; see Figure 7 ; see Figure 8	-	3.7	4.3	m Ω
Avalanche ruggedness						
$E_{DS(AL)S}$	non-repetitive drain-source avalanche energy	$I_D = 100\text{ A}$; $V_{sup} \leq 75\text{ V}$; $R_{GS} = 50\text{ }\Omega$; $V_{GS} = 10\text{ V}$; $T_{j(init)} = 25\text{ °C}$; unclamped	-	-	630	mJ

[1] Continuous current is limited by package.

[2] Refer to document 9397 750 12572 for further information.



2. Pinning information

Table 2. Pinning information

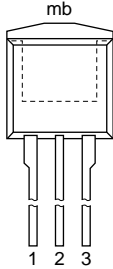
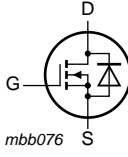
Pin	Symbol	Description	Simplified outline	Graphic symbol
1	G	gate		
2	D	drain		
3	S	source		
mb	D	mounting base; connected to drain		

SOT226 (I2PAK)

3. Ordering information

Table 3. Ordering information

Type number	Package		
	Name	Description	Version
BUK7E4R3-75C	I2PAK	plastic single-ended package (I2PAK); TO-262	SOT226

4. Limiting values

Table 4. Limiting values

In accordance with the Absolute Maximum Rating System (IEC 60134).

Symbol	Parameter	Conditions	Min	Max	Unit	
V_{DS}	drain-source voltage	$T_j \geq 25\text{ °C}; T_j \leq 175\text{ °C}$	-	75	V	
V_{DGR}	drain-gate voltage	$R_{GS} = 20\text{ k}\Omega$	-	75	V	
V_{GS}	gate-source voltage		-20	20	V	
I_D	drain current	$T_{mb} = 100\text{ °C}; V_{GS} = 10\text{ V};$ see Figure 1 ; see Figure 4	[1][2]	-	100	A
		$T_{mb} = 25\text{ °C}; V_{GS} = 10\text{ V};$ see Figure 1 ; see Figure 4	[1][2]	-	100	A
			[3][2]	-	192	A
I_{DM}	peak drain current	$T_{mb} = 25\text{ °C};$ pulsed; $t_p \leq 10\text{ }\mu\text{s};$ see Figure 4	-	769	A	
P_{tot}	total power dissipation	$T_{mb} = 25\text{ °C};$ see Figure 2	-	333	W	
T_{stg}	storage temperature		-55	175	°C	
T_j	junction temperature		-55	175	°C	
Source-drain diode						
I_S	source current	$T_{mb} = 25\text{ °C}$	[2][1]	-	100	A
			[2][3]	-	192	A
I_{SM}	peak source current	pulsed; $t_p \leq 10\text{ }\mu\text{s}; T_{mb} = 25\text{ °C}$	-	769	A	
Avalanche ruggedness						
$E_{DS(AL)S}$	non-repetitive drain-source avalanche energy	$I_D = 100\text{ A}; V_{sup} \leq 75\text{ V}; R_{GS} = 50\text{ }\Omega;$ $V_{GS} = 10\text{ V}; T_{j(init)} = 25\text{ °C};$ unclamped	-	630	mJ	
$E_{DS(AL)R}$	repetitive drain-source avalanche energy	see Figure 3	[4][5][6][7]	-	mJ	

[1] Continuous current is limited by package.

[2] Refer to document 9397 750 12572 for further information.

[3] Current is limited by power dissipation chip rating.

[4] Maximum value not quoted. Repetitive rating defined in avalanche rating figure.

[5] Single-pulse avalanche rating limited by maximum junction temperature of 175 °C.

[6] Repetitive avalanche rating limited by an average junction temperature of 170 °C.

[7] Refer to application note AN10273 for further information.

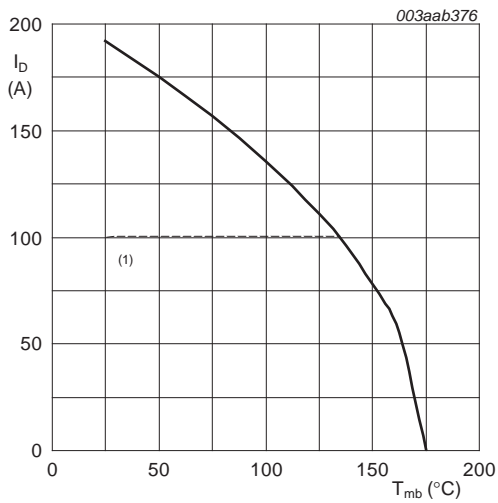

$V_{GS} \geq 10\text{ V}$
 (1) Capped at 100 A due to package.

Fig 1. Continuous drain current as a function of mounting base temperature

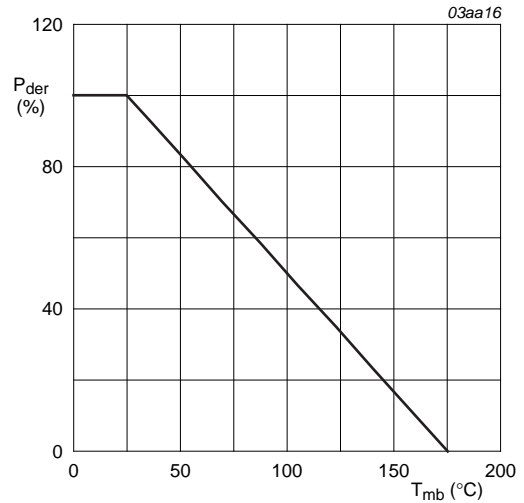

$$P_{der} = \frac{P_{tot}}{P_{tot(25^\circ\text{C})}} \times 100\%$$

Fig 2. Normalized total power dissipation as a function of mounting base temperature

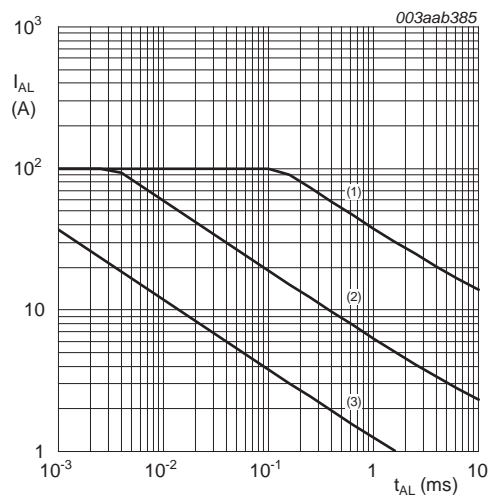
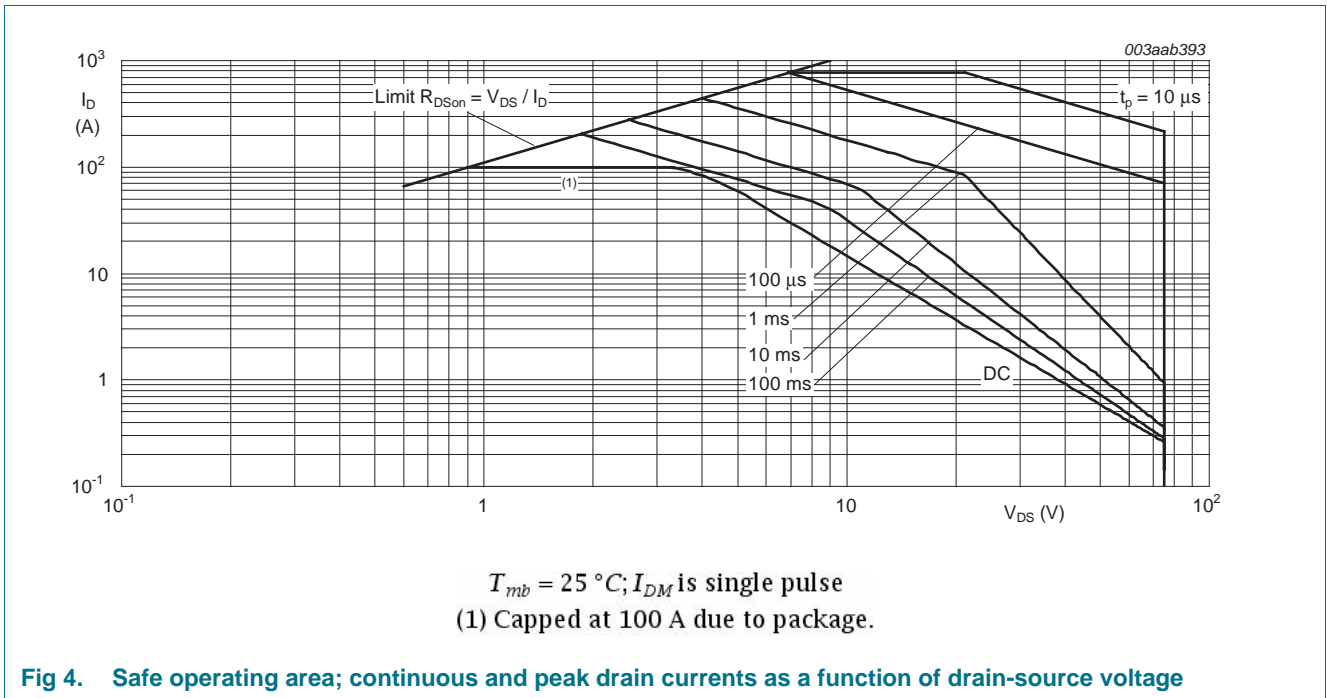

Fig 3. Single-pulse and repetitive avalanche rating; avalanche current as a function of avalanche time.



5. Thermal characteristics

Table 5. Thermal characteristics

Symbol	Parameter	Conditions	Min	Typ	Max	Unit
$R_{th(j-mb)}$	thermal resistance from junction to mounting base		-	-	0.45	K/W
$R_{th(j-a)}$	thermal resistance from junction to ambient	vertical in free air	-	50	-	K/W

6. Characteristics

Table 6. Characteristics

Symbol	Parameter	Conditions	Min	Typ	Max	Unit
Static characteristics						
$V_{(BR)DSS}$	drain-source breakdown voltage	$I_D = 250 \mu A; V_{GS} = 0 V; T_j = -55 \text{ }^\circ C$	70	-	-	V
		$I_D = 250 \mu A; V_{GS} = 0 V; T_j = 25 \text{ }^\circ C$	75	-	-	V
$V_{GS(th)}$	gate-source threshold voltage	$I_D = 1 \text{ mA}; V_{DS} = V_{GS}; T_j = -55 \text{ }^\circ C$; see Figure 5 ; see Figure 6	-	-	4.4	V
V_{GSth}	gate-source threshold voltage	$I_D = 1 \text{ mA}; V_{DS} = V_{GS}; T_j = 25 \text{ }^\circ C$; see Figure 5 ; see Figure 6	2	3	4	V
		$I_D = 1 \text{ mA}; V_{DS} = V_{GS}; T_j = 175 \text{ }^\circ C$; see Figure 5 ; see Figure 6	1	-	-	V
I_{DSS}	drain leakage current	$V_{DS} = 75 \text{ V}; V_{GS} = 0 \text{ V}; T_j = 25 \text{ }^\circ C$	-	0.02	1	μA
I_{GSS}	gate leakage current	$V_{GS} = 20 \text{ V}; V_{DS} = 0 \text{ V}; T_j = 25 \text{ }^\circ C$	-	2	100	nA
		$V_{GS} = -20 \text{ V}; V_{DS} = 0 \text{ V}; T_j = 25 \text{ }^\circ C$	-	2	100	nA
R_{DSon}	drain-source on-state resistance	$V_{GS} = 10 \text{ V}; I_D = 25 \text{ A}; T_j = 175 \text{ }^\circ C$; see Figure 7 ; see Figure 8	-	-	9	m Ω
		$V_{GS} = 10 \text{ V}; I_D = 25 \text{ A}; T_j = 25 \text{ }^\circ C$; see Figure 7 ; see Figure 8	-	3.7	4.3	m Ω
I_{DSS}	drain leakage current	$V_{DS} = 75 \text{ V}; V_{GS} = 0 \text{ V}; T_j = 175 \text{ }^\circ C$	-	-	500	μA
Dynamic characteristics						
$Q_{G(tot)}$	total gate charge	$I_D = 25 \text{ A}; V_{DS} = 60 \text{ V}; V_{GS} = 10 \text{ V}$; see Figure 9	-	142	-	nC
Q_{GS}	gate-source charge		-	36	-	nC
Q_{GD}	gate-drain charge		-	67	-	nC
C_{iss}	input capacitance	$V_{GS} = 0 \text{ V}; V_{DS} = 25 \text{ V}; f = 1 \text{ MHz}$; $T_j = 25 \text{ }^\circ C$; see Figure 10	-	8744	11659	pF
C_{oss}	output capacitance		-	923	1108	pF
C_{rss}	reverse transfer capacitance		-	579	793	pF
$t_{d(on)}$	turn-on delay time	$V_{DS} = 30 \text{ V}; R_L = 1.2 \text{ } \Omega; V_{GS} = 10 \text{ V}$; $R_{G(ext)} = 10 \text{ } \Omega$	-	61	-	ns
t_r	rise time		-	100	-	ns
$t_{d(off)}$	turn-off delay time		-	194	-	ns
t_f	fall time		-	90	-	ns
L_D	internal drain inductance	from contact screw on mounting base to centre of die	-	3.5	-	nH
		from drain lead 6mm from package to centre of die	-	4.5	-	nH
		from upper edge of drain mounting base to centre of die	-	2.5	-	nH
L_S	internal source inductance	from source lead to source bonding pad	-	7.5	-	nH
Source-drain diode						
V_{SD}	source-drain voltage	$I_S = 25 \text{ A}; V_{GS} = 0 \text{ V}; T_j = 25 \text{ }^\circ C$; see Figure 11	-	0.85	1.2	V
t_{rr}	reverse recovery time	$I_S = 20 \text{ A}; dI_S/dt = -100 \text{ A}/\mu s; V_{GS} = 0 \text{ V}$; $V_{DS} = 25 \text{ V}$	-	83	-	ns
Q_r	recovered charge		-	155	-	nC

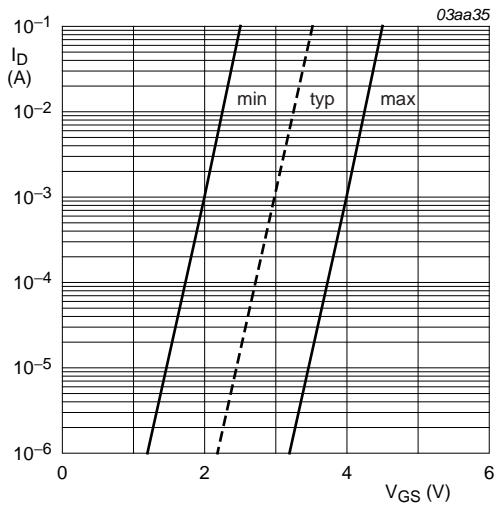

$$T_j = 25^\circ\text{C}; V_{DS} = 5\text{V}$$

Fig 5. Sub-threshold drain current as a function of gate-source voltage

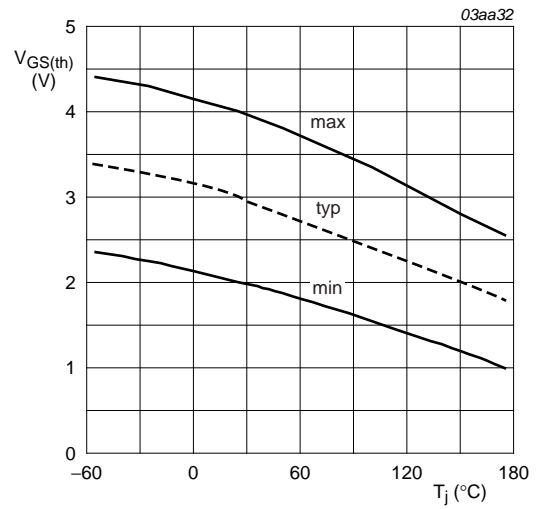

$$I_D = 1\text{mA}; V_{DS} = V_{GS}$$

Fig 6. Gate-source threshold voltage as a function of junction temperature

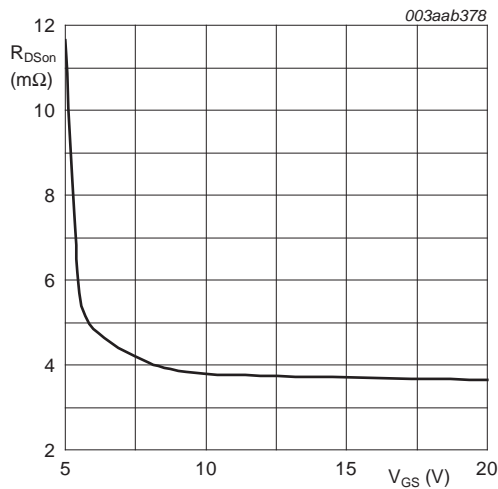

$$T_j = 25^\circ\text{C}; I_D = 25\text{A}$$

Fig 7. Drain source on-state resistance as a function of gate-source voltage; typical values

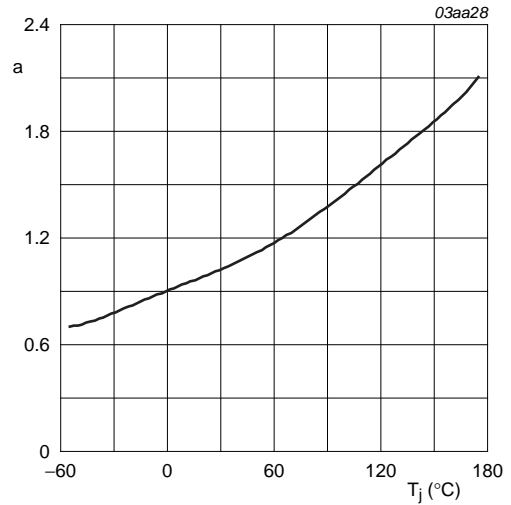

$$a = \frac{R_{DSon}}{R_{DSon(25^\circ\text{C})}}$$

Fig 8. Normalized drain-source on-state resistance factor as a function of junction temperature

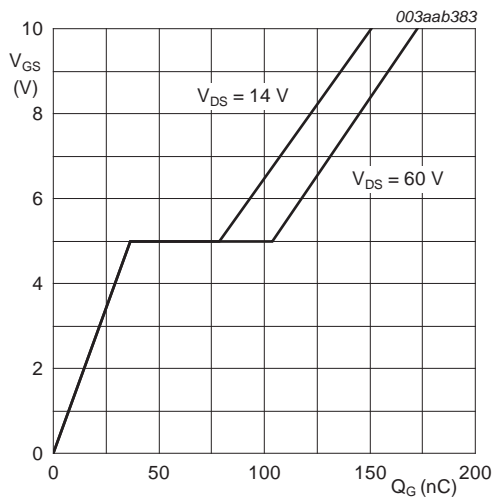

$T_j = 25\text{ }^\circ\text{C}; I_D = 25\text{ A}$

Fig 9. Gate-source voltage as a function of gate charge; typical values

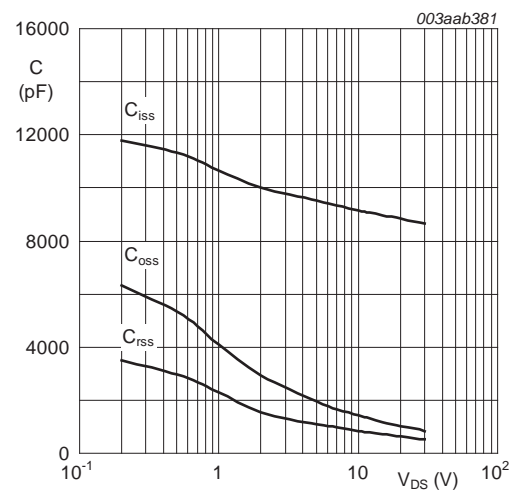

$V_{GS} = 0\text{ V}; f = 1\text{ MHz}$

Fig 10. Input, output and reverse transfer capacitances as a function of drain-source voltage; typical values

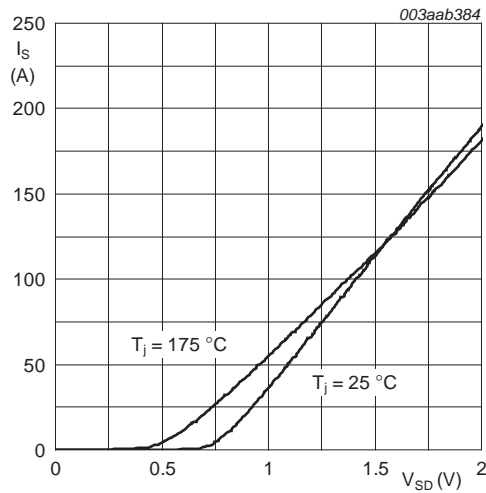

$V_{GS} = 0\text{ V}$

Fig 11. Source current as a function of source-drain diode; typical values

7. Package outline

Plastic single-ended package (I2PAK); low-profile 3-lead TO-262

SOT226

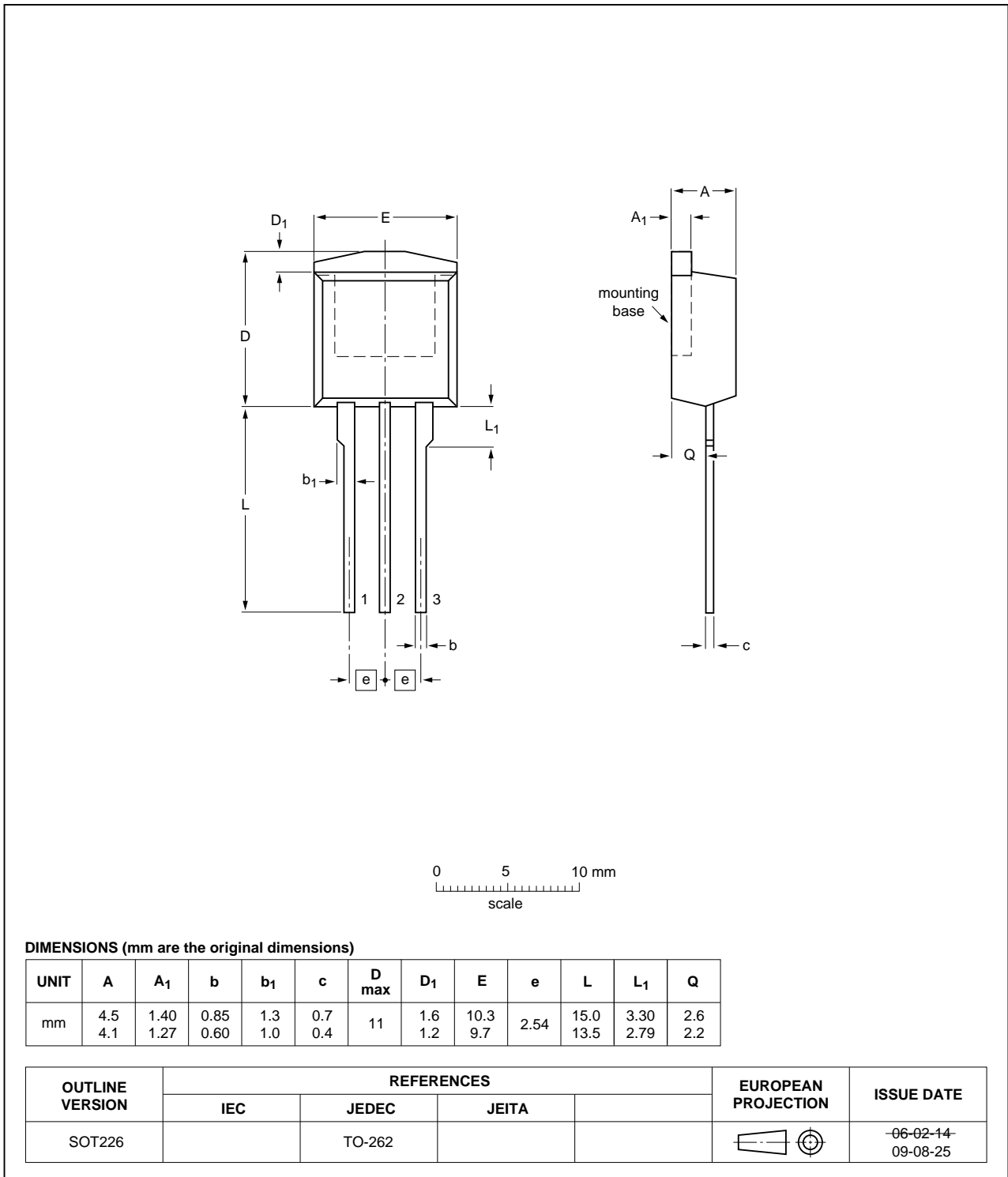

Fig 12. Package outline SOT226 (I2PAK)

8. Revision history

Table 7. Revision history

Document ID	Release date	Data sheet status	Change notice	Supersedes
BUK7E4R3-75C v.2	20110419	Product data sheet	-	BUK75_7E4R3-75C v.1
Modifications:	<ul style="list-style-type: none">• The format of this data sheet has been redesigned to comply with the new identity guidelines of NXP Semiconductors.• Legal texts have been adapted to the new company name where appropriate.• Type number BUK7E4R3-75C separated from data sheet BUK75_7E4R3-75C v.1.			
BUK75_7E4R3-75C v.1	20060810	Product data sheet	-	-

9. Legal information

9.1 Data sheet status

Document status ^[1] ^[2]	Product status ^[3]	Definition
Objective [short] data sheet	Development	This document contains data from the objective specification for product development.
Preliminary [short] data sheet	Qualification	This document contains data from the preliminary specification.
Product [short] data sheet	Production	This document contains the product specification.

[1] Please consult the most recently issued document before initiating or completing a design.

[2] The term 'short data sheet' is explained in section "Definitions".

[3] The product status of device(s) described in this document may have changed since this document was published and may differ in case of multiple devices. The latest product status information is available on the Internet at URL <http://www.nxp.com>.

9.2 Definitions

Preview — The document is a preview version only. The document is still subject to formal approval, which may result in modifications or additions. NXP Semiconductors does not give any representations or warranties as to the accuracy or completeness of information included herein and shall have no liability for the consequences of use of such information.

Draft — The document is a draft version only. The content is still under internal review and subject to formal approval, which may result in modifications or additions. NXP Semiconductors does not give any representations or warranties as to the accuracy or completeness of information included herein and shall have no liability for the consequences of use of such information.

Short data sheet — A short data sheet is an extract from a full data sheet with the same product type number(s) and title. A short data sheet is intended for quick reference only and should not be relied upon to contain detailed and full information. For detailed and full information see the relevant full data sheet, which is available on request via the local NXP Semiconductors sales office. In case of any inconsistency or conflict with the short data sheet, the full data sheet shall prevail.

Product specification — The information and data provided in a Product data sheet shall define the specification of the product as agreed between NXP Semiconductors and its customer, unless NXP Semiconductors and customer have explicitly agreed otherwise in writing. In no event however, shall an agreement be valid in which the NXP Semiconductors product is deemed to offer functions and qualities beyond those described in the Product data sheet.

9.3 Disclaimers

Limited warranty and liability — Information in this document is believed to be accurate and reliable. However, NXP Semiconductors does not give any representations or warranties, expressed or implied, as to the accuracy or completeness of such information and shall have no liability for the consequences of use of such information.

In no event shall NXP Semiconductors be liable for any indirect, incidental, punitive, special or consequential damages (including - without limitation - lost profits, lost savings, business interruption, costs related to the removal or replacement of any products or rework charges) whether or not such damages are based on tort (including negligence), warranty, breach of contract or any other legal theory.

Notwithstanding any damages that customer might incur for any reason whatsoever, NXP Semiconductors' aggregate and cumulative liability towards customer for the products described herein shall be limited in accordance with the *Terms and conditions of commercial sale* of NXP Semiconductors.

Right to make changes — NXP Semiconductors reserves the right to make changes to information published in this document, including without limitation specifications and product descriptions, at any time and without notice. This document supersedes and replaces all information supplied prior to the publication hereof.

Suitability for use in automotive applications — This NXP Semiconductors product has been qualified for use in automotive applications. The product is not designed, authorized or warranted to be suitable for use in medical, military, aircraft, space or life support equipment, nor in applications where failure or malfunction of an NXP Semiconductors product can reasonably be expected to result in personal injury, death or severe property or environmental damage. NXP Semiconductors accepts no liability for inclusion and/or use of NXP Semiconductors products in such equipment or applications and therefore such inclusion and/or use is at the customer's own risk.

Quick reference data — The Quick reference data is an extract of the product data given in the Limiting values and Characteristics sections of this document, and as such is not complete, exhaustive or legally binding.

Applications — Applications that are described herein for any of these products are for illustrative purposes only. NXP Semiconductors makes no representation or warranty that such applications will be suitable for the specified use without further testing or modification.

Customers are responsible for the design and operation of their applications and products using NXP Semiconductors products, and NXP Semiconductors accepts no liability for any assistance with applications or customer product design. It is customer's sole responsibility to determine whether the NXP Semiconductors product is suitable and fit for the customer's applications and products planned, as well as for the planned application and use of customer's third party customer(s). Customers should provide appropriate design and operating safeguards to minimize the risks associated with their applications and products.

NXP Semiconductors does not accept any liability related to any default, damage, costs or problem which is based on any weakness or default in the customer's applications or products, or the application or use by customer's third party customer(s). Customer is responsible for doing all necessary testing for the customer's applications and products using NXP Semiconductors products in order to avoid a default of the applications and the products or of the application or use by customer's third party customer(s). NXP does not accept any liability in this respect.

Limiting values — Stress above one or more limiting values (as defined in the Absolute Maximum Ratings System of IEC 60134) will cause permanent damage to the device. Limiting values are stress ratings only and (proper) operation of the device at these or any other conditions above those given in the Recommended operating conditions section (if present) or the

Characteristics sections of this document is not warranted. Constant or repeated exposure to limiting values will permanently and irreversibly affect the quality and reliability of the device.

Terms and conditions of commercial sale — NXP Semiconductors products are sold subject to the general terms and conditions of commercial sale, as published at <http://www.nxp.com/profile/terms>, unless otherwise agreed in a valid written individual agreement. In case an individual agreement is concluded only the terms and conditions of the respective agreement shall apply. NXP Semiconductors hereby expressly objects to applying the customer's general terms and conditions with regard to the purchase of NXP Semiconductors products by customer.

No offer to sell or license — Nothing in this document may be interpreted or construed as an offer to sell products that is open for acceptance or the grant, conveyance or implication of any license under any copyrights, patents or other industrial or intellectual property rights.

Export control — This document as well as the item(s) described herein may be subject to export control regulations. Export might require a prior authorization from national authorities.

9.4 Trademarks

Notice: All referenced brands, product names, service names and trademarks are the property of their respective owners.

Adelante, Bitport, Bitsound, CoolFlux, CoReUse, DESFire, EZ-HV, FabKey, GreenChip, HiPerSmart, HITAG, I²C-bus logo, ICODE, I-CODE, ITEC, Labelution, MIFARE, MIFARE Plus, MIFARE Ultralight, MoReUse, QLPAK, Silicon Tuner, SiliconMAX, SmartXA, STARplug, TOPFET, TrenchMOS, TriMedia and UCODE — are trademarks of NXP B.V.

HD Radio and HD Radio logo — are trademarks of iBiquity Digital Corporation.

10. Contact information

For more information, please visit: <http://www.nxp.com>

For sales office addresses, please send an email to: salesaddresses@nxp.com

11. Contents

1	Product profile	1
1.1	General description	1
1.2	Features and benefits	1
1.3	Applications	1
1.4	Quick reference data	1
2	Pinning information	2
3	Ordering information	2
4	Limiting values	3
5	Thermal characteristics	5
6	Characteristics	6
7	Package outline	9
8	Revision history	10
9	Legal information	11
9.1	Data sheet status	11
9.2	Definitions	11
9.3	Disclaimers	11
9.4	Trademarks	12
10	Contact information	12

Please be aware that important notices concerning this document and the product(s) described herein, have been included in section 'Legal information'.

© NXP B.V. 2011.

All rights reserved.

For more information, please visit: <http://www.nxp.com>

For sales office addresses, please send an email to: salesaddresses@nxp.com

Date of release: 19 April 2011

Document identifier: BUK7E4R3-75C