

DETAILS

Product Number	FP13025_LISA2-W-PIN
Family	Lisa
Type	Assembly
Color	black
Diameter	10 mm
Height	6,8 mm
Style	round
Optic Material	PMMA
Holder Material	
Fastening	glue, pin
Status	production ready
ROHS Compliant	Yes
Date Updated	15/04/2016



OPTICAL PROPERTIES

LED	Viewing	Light	Effi-		Connector
	Angle	Beam	ciency	cd/lm	
XT-E	32 deg	Wide	84 %	2.200	-
XP-G2	36 deg	Wide	88 %	2.200	-
XP-G3	39 deg	Wide	84 %	1.860	-
H35C1 (LEMWA33)	40 deg	Wide	88 %	2.000	-
LUXEON T	36 deg	Wide	86 %	2.000	-
LUXEON H50-2	sim: 30	Wide	sim: 89 %	sim: 2.800	-
LUXEON TX	34 deg	Wide	88 %	2.500	-
NCSxx19B	34 deg	Wide	84 %	2.600	-
NVSxx19B/NVSxx19C	38 deg	Wide	86 %	2.000	-
SFH 4715S	24 deg	Wide	-	-	-
SFH 4725S	24 deg	Wide	-	-	-
Oslon Square EC	33 deg	Wide	85 %	2.400	-
Oslon Black	sim: 22	Wide	sim: 90 %	sim: 5.700	-
LH351Z	38 deg	Wide	88 %	2.100	-
LH351B	39 deg	Wide	88 %	1.880	-
Z8Y22P	sim: 38	Wide	sim: 84 %	sim: 1.590	-

Relative intensity of FP13025_LISA2-W-PIN_(SFH_4715S)

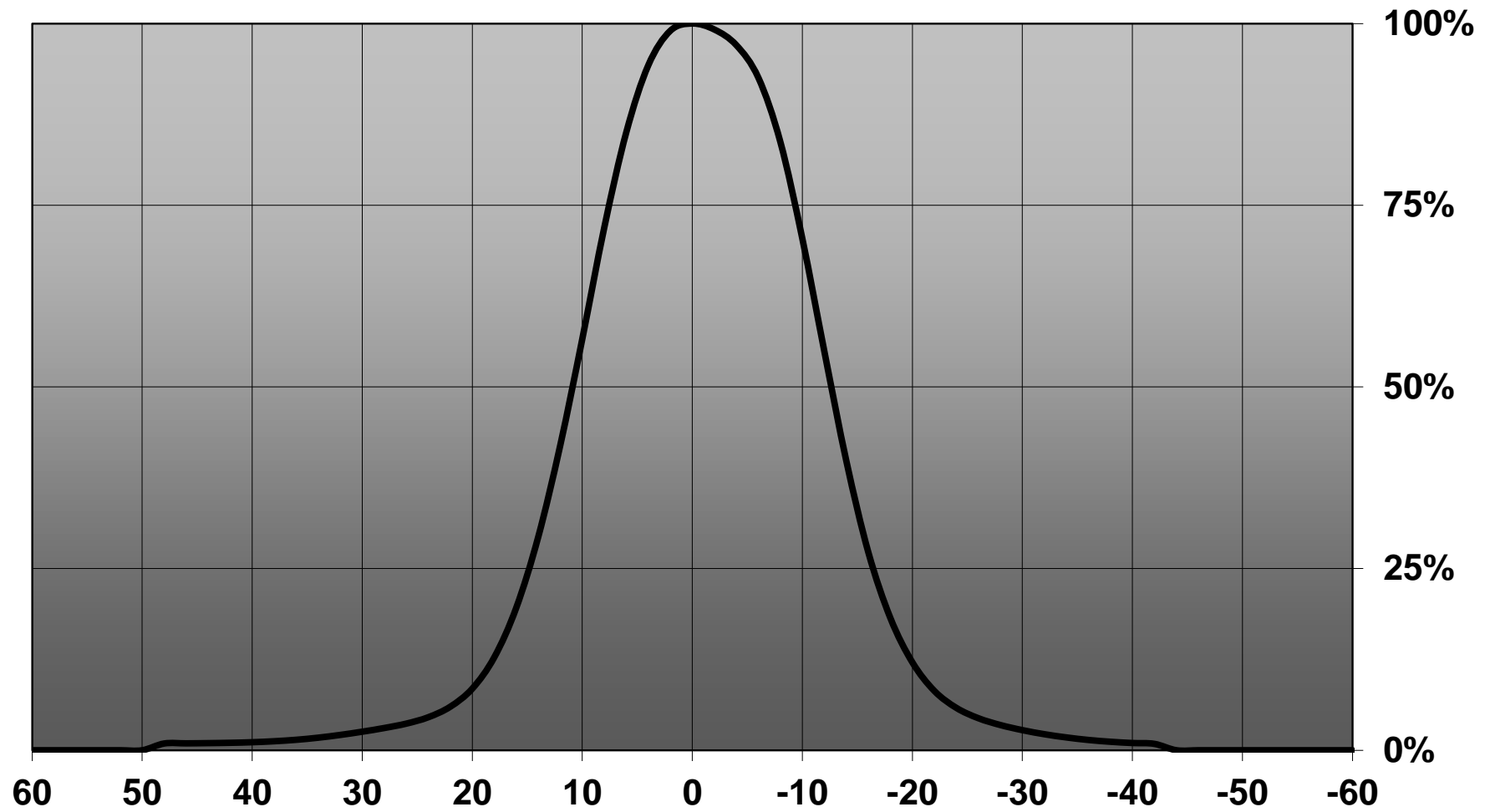

Relative intensity of FP13025_LISA2-W-PIN_(SFH4725)

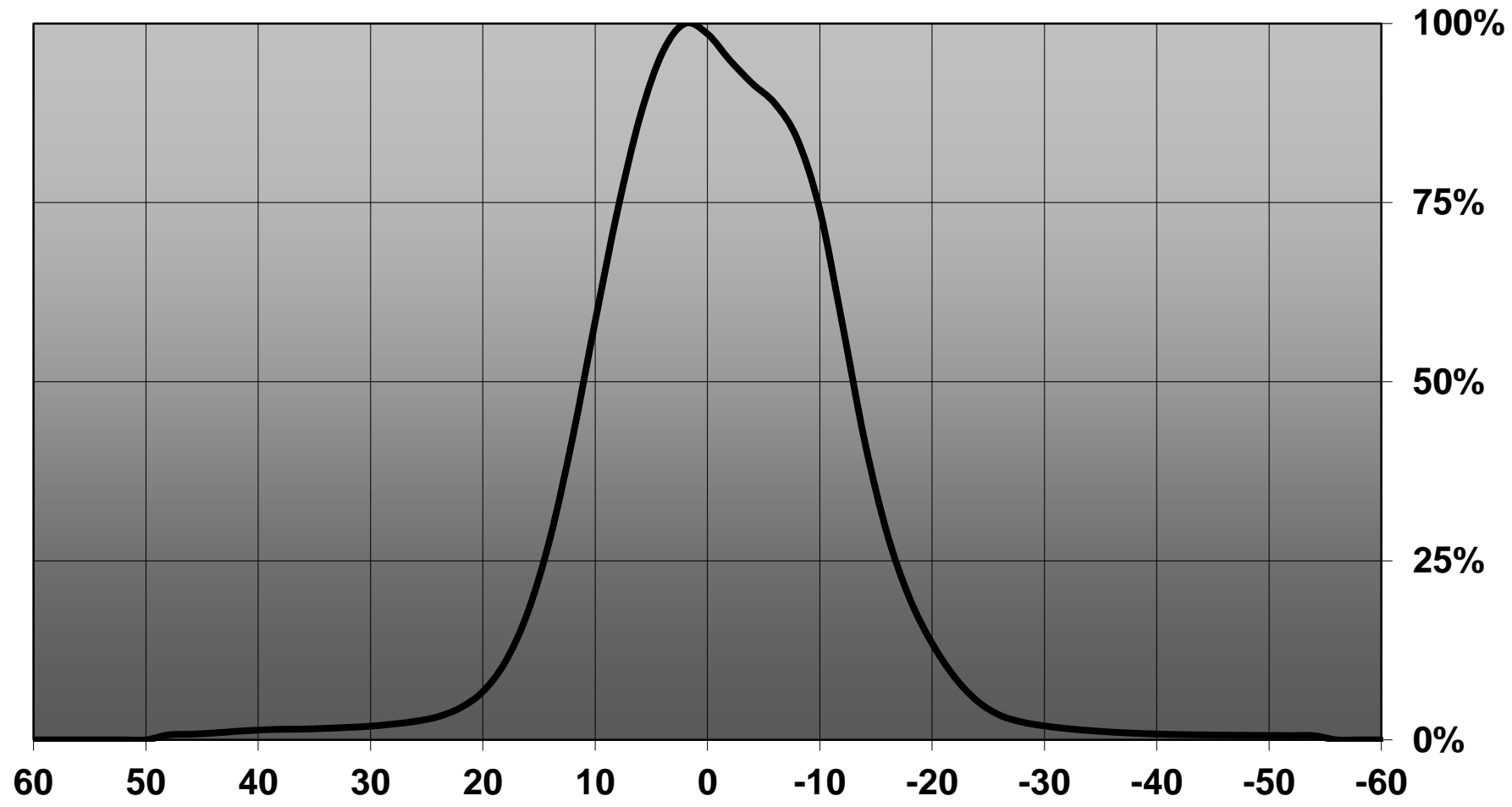

Relative intensity of FP13025_LISA2-W-PIN_(LH351B)

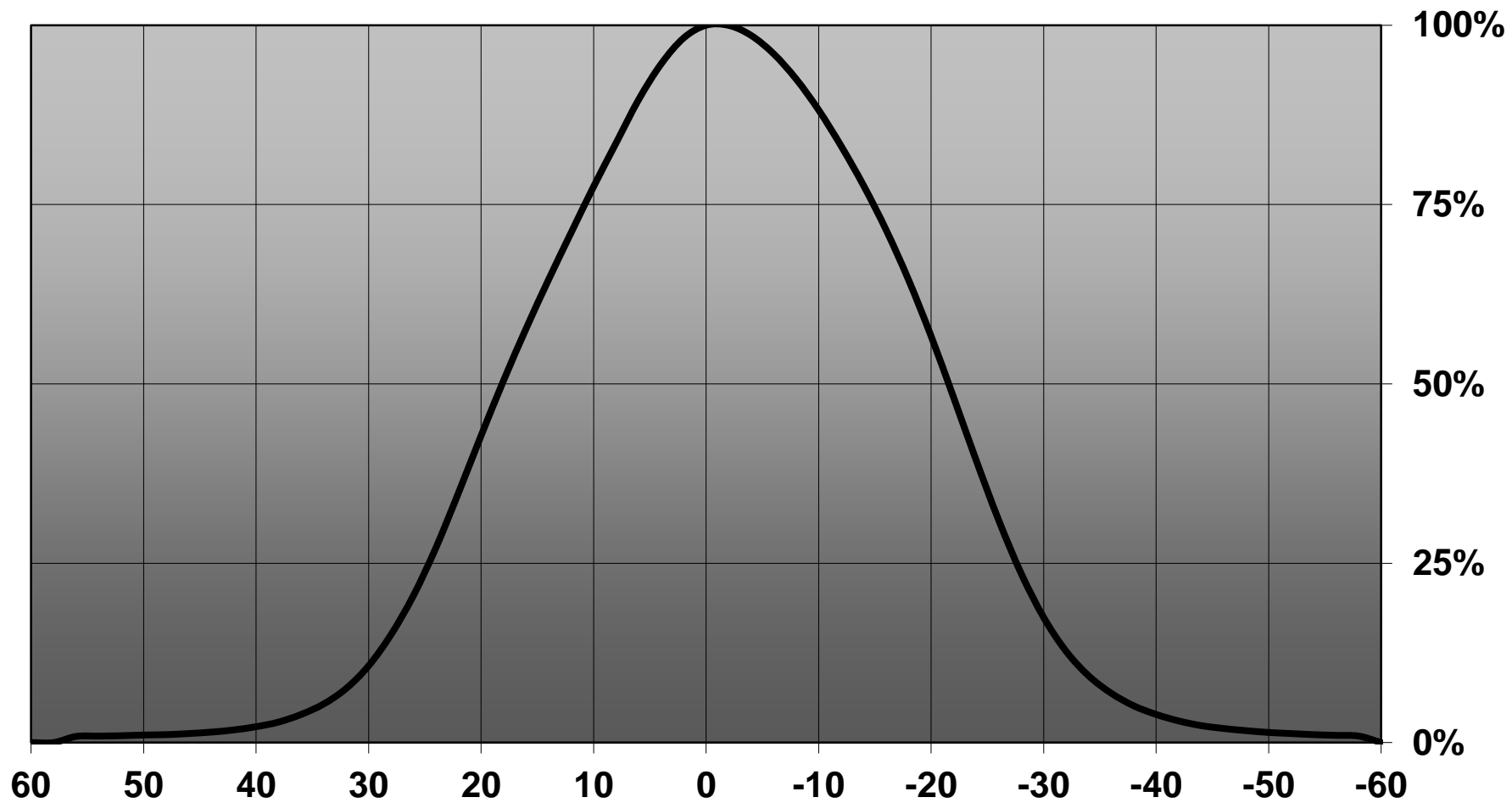

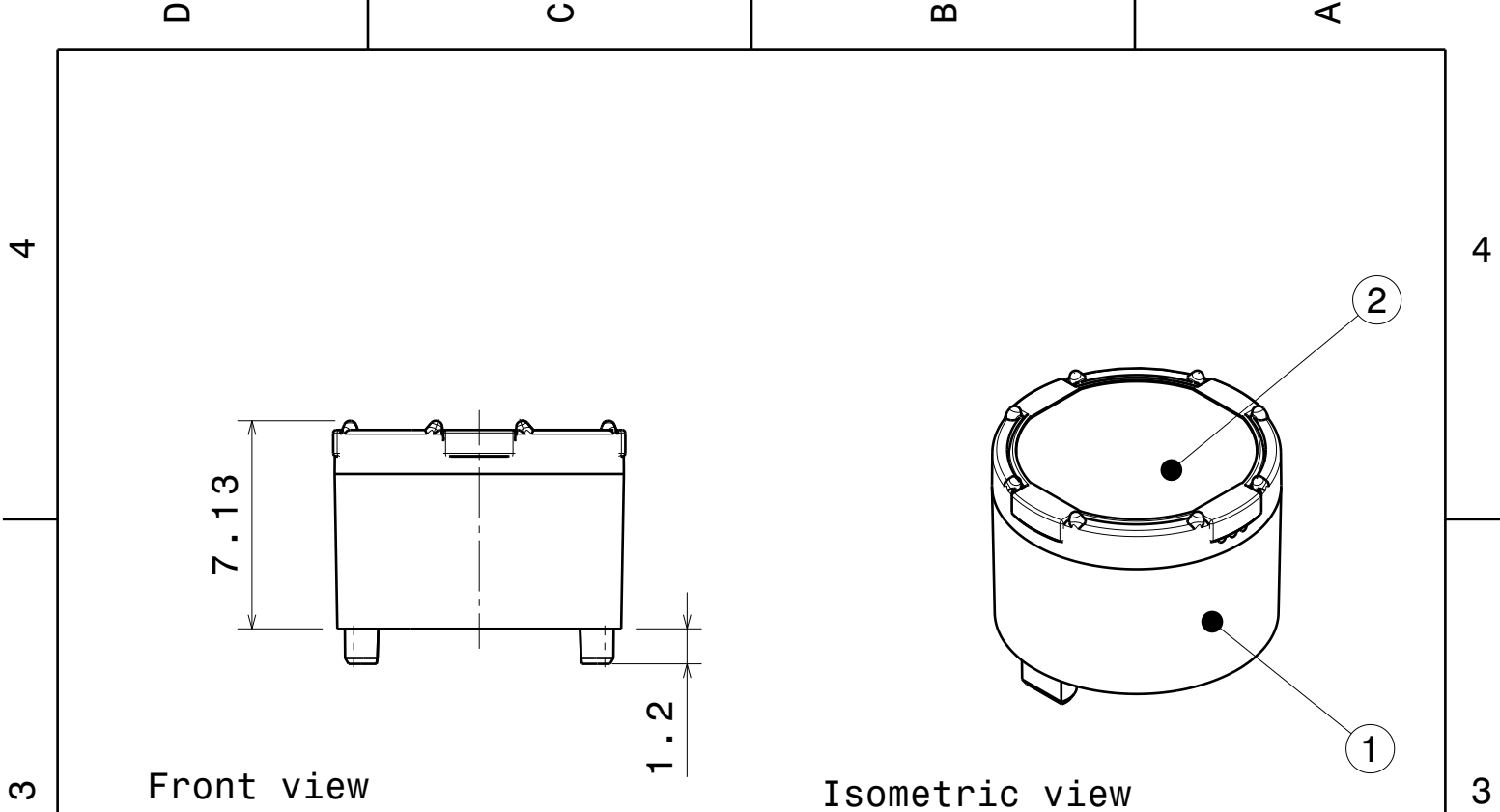

Front view

Isometric view

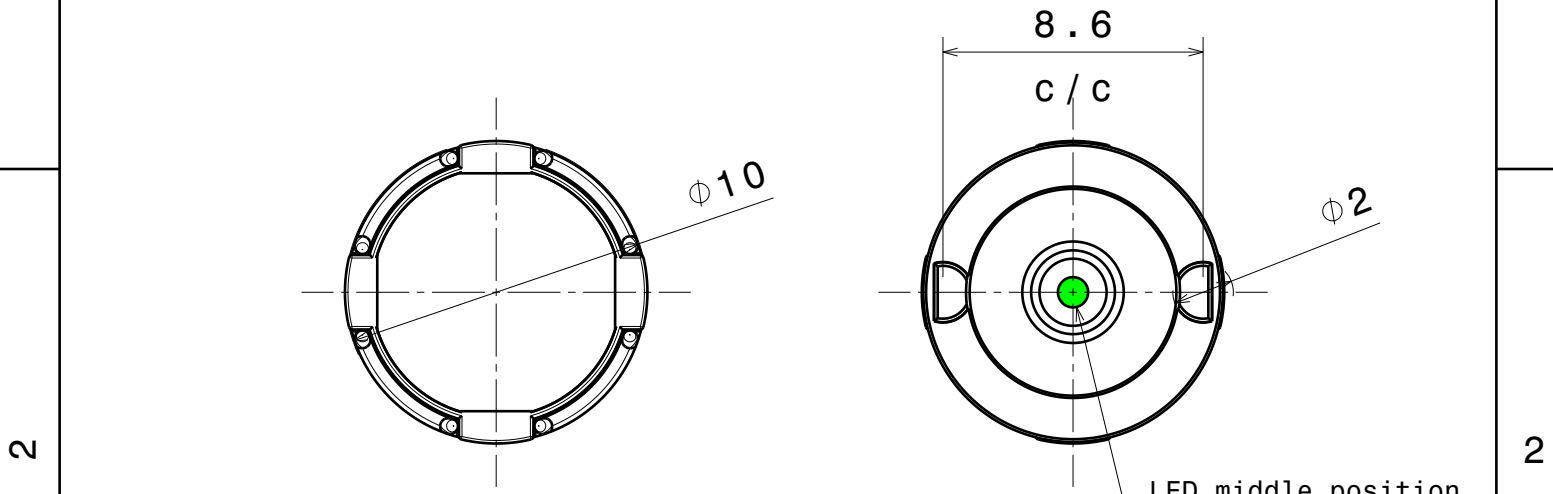

Top view

Bottom view

INDEX	PART NO	DESCRIPTION	MATERIAL	COLOUR
1	F10989	LISA2-HLD-PIN	PC	black
2	-	LISA2_lens	PMMA	

Tolerances if not otherwise shown
 According to DIN ISO 2768-1
 Linear measures:
 up to 30mm class M, otherwise class C
 According to DIN ISO 2768-2
 Form and position: class L

LEDiL LediL Oy
 Salorankatu 10
 FIN 24240 SALO
 Finland

THIRD ANGLE PROJECTION:

DRAWING TITLE
Lisa2-PIN-XP assembly

This drawing is the property of LEDiL Oy. It may not be reproduced, copied or communicated without a written agreement with LEDiL Oy.

SIZE	PART NUMBER
A4	-

SCALE	4:1	WEIGHT	0,5 g	SHEET	1/1
-------	-----	--------	-------	-------	-----

Luminaire: LEDIL OY FP13025_LISA2-W-PIN & FP13031_LISA2-W-CLIP-XTE (Cree XT-E 98lm @ 250mA) Efficiency=84%
Lamps: 1 x CREE XT-E (98.9lm)

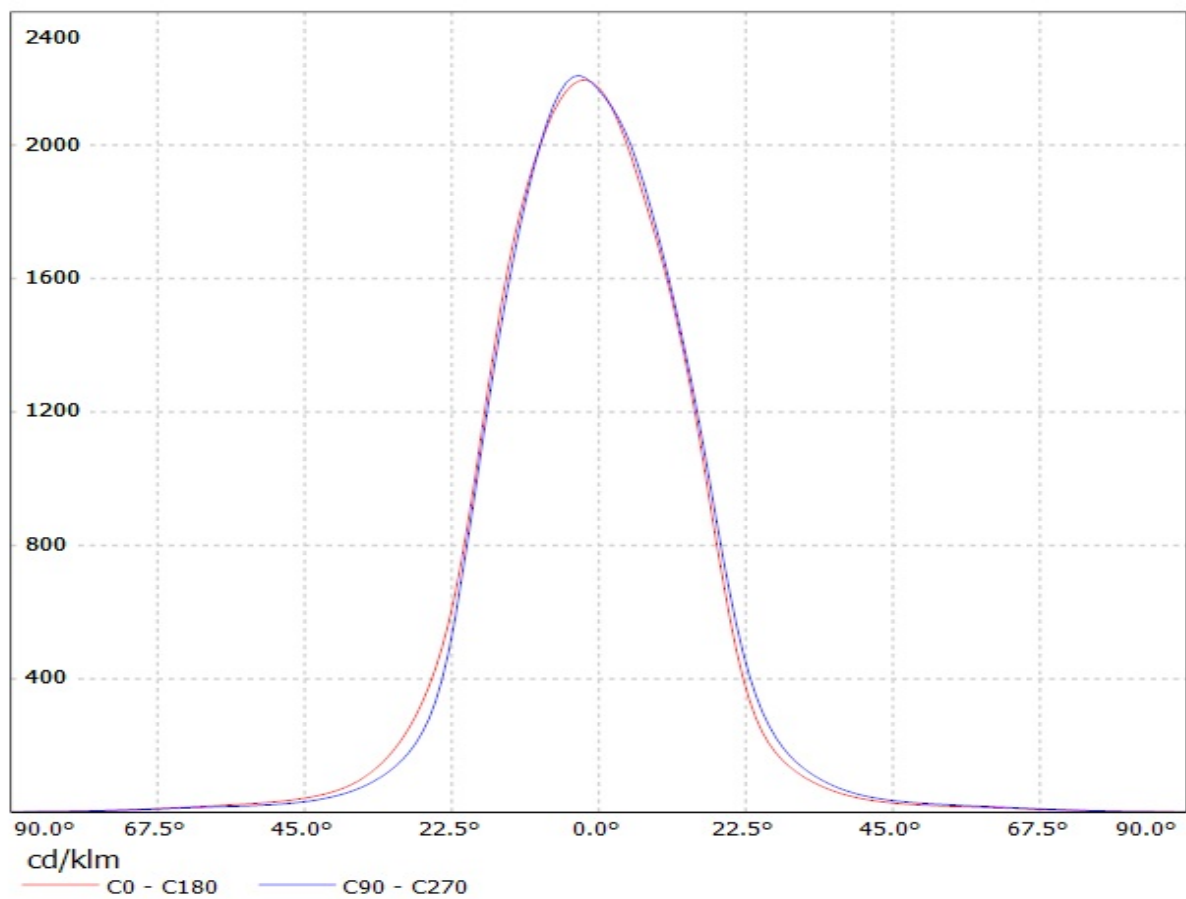

Luminaire: LEDiL Oy FP13025&FP13031_LISA2-W_(PIN&CLIP)_ (XP-G2) Eff.88%
Lamps: 1 x Cree_(XP-G2) 104lm@250mA CCT=6600K P=0.76W I=250mA

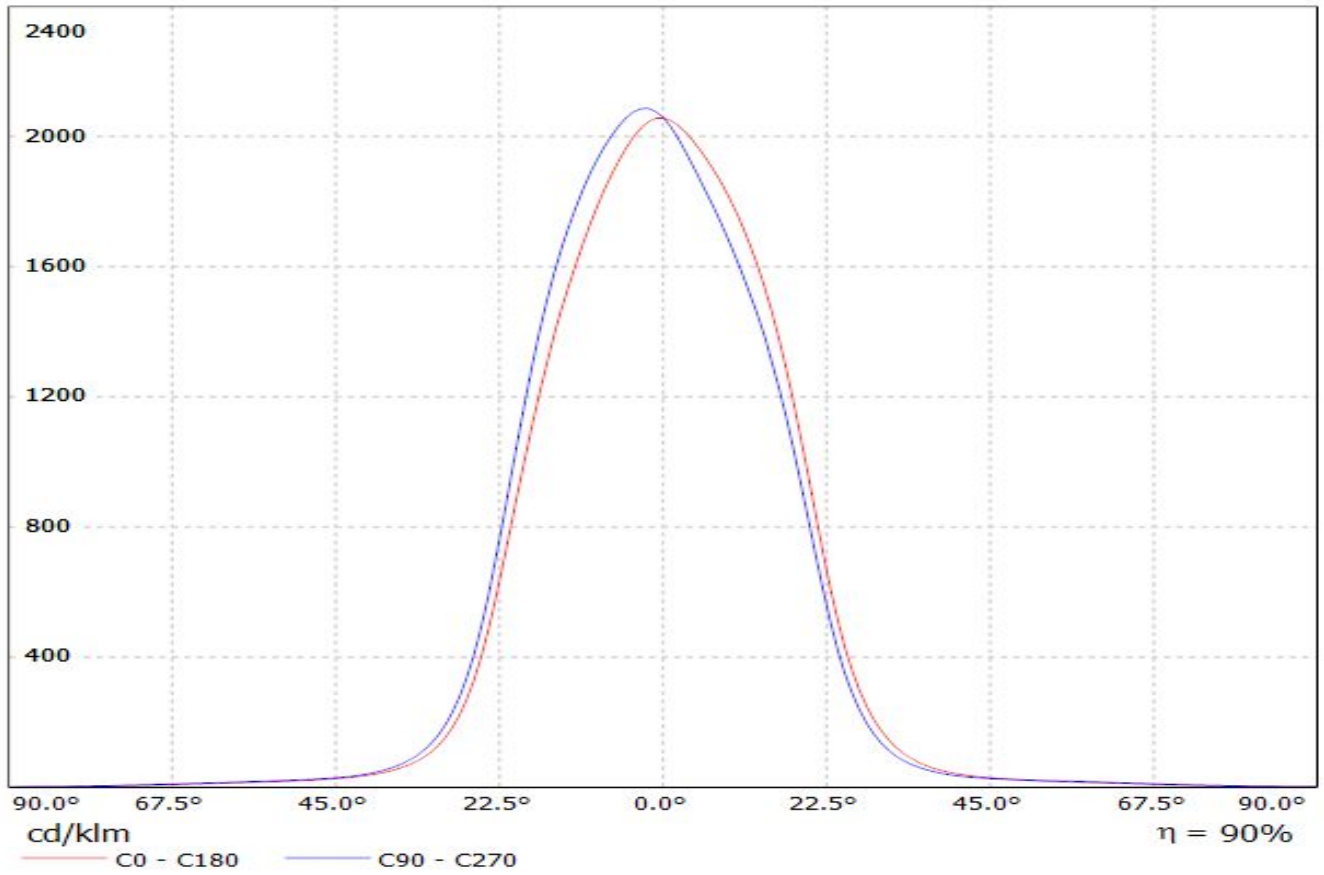

Luminaire: Ledil Oy
Lamps: 1 x

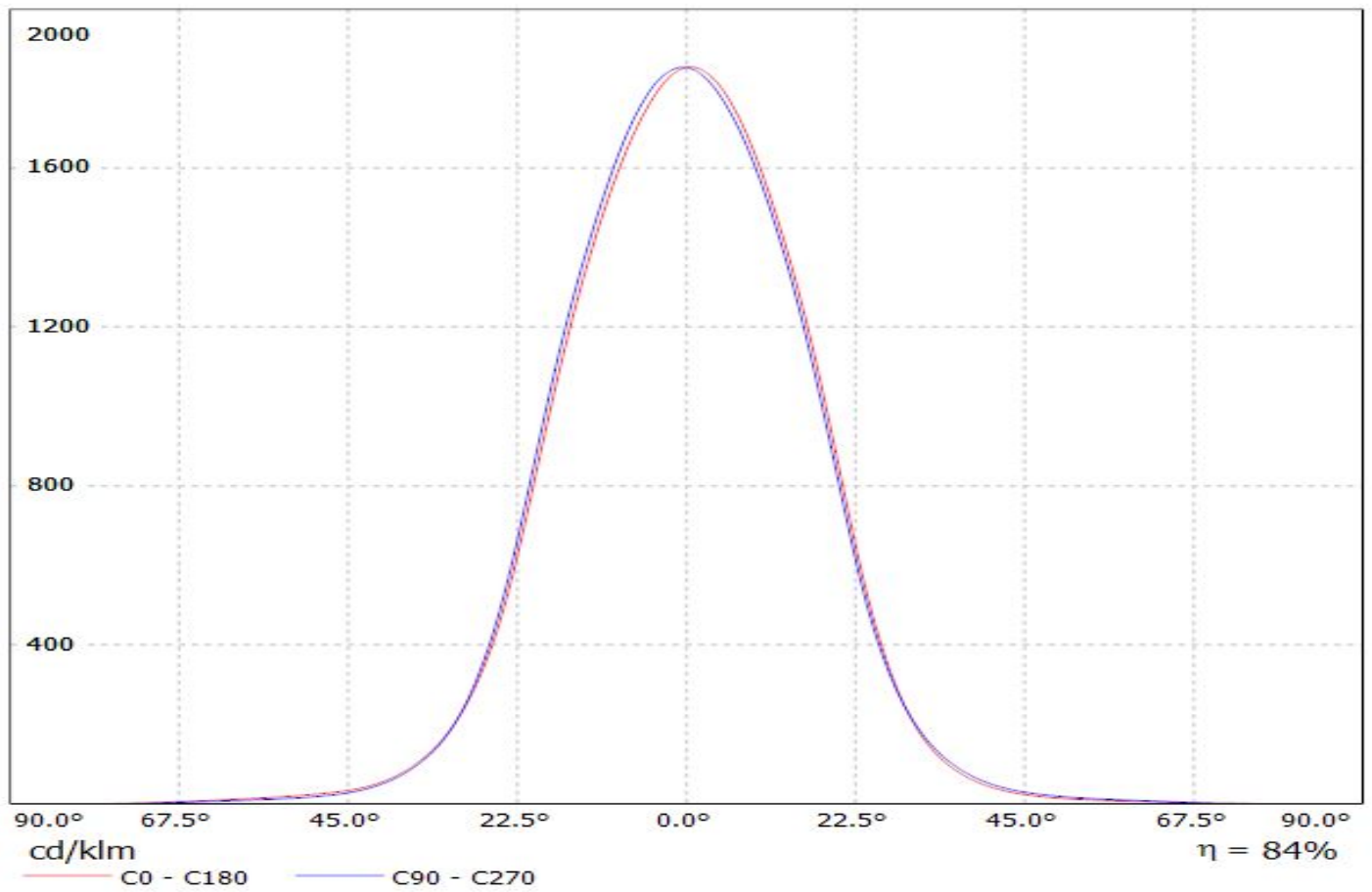

Luminaire: Ledil Oy FP13025_LISA2-W-PIN_(3535_Ceramic_gen2) Efficiency=88%
Lamps: 1 x LG 3535 Ceramic gen2 (PKG5700K) 116lm @ 250mA CCT=6200K P=0.7W I=250mA

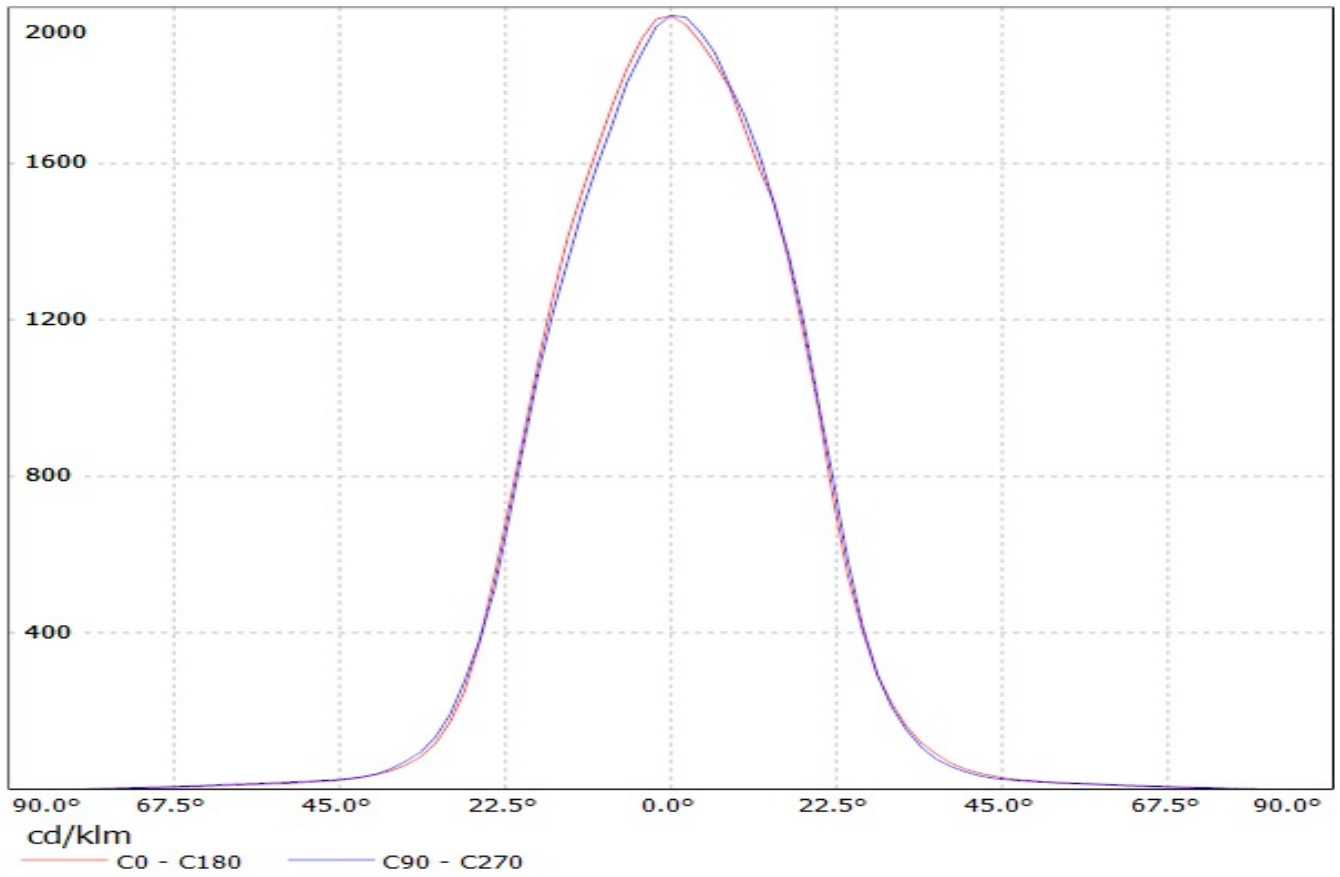

Luminaire: LEDiL Oy FP13031 & FP13025_LISA2-W_(CLIP/PIN) Eff.86.1%
Lamps: 1 x LUXEON_T (74lm@250mA)

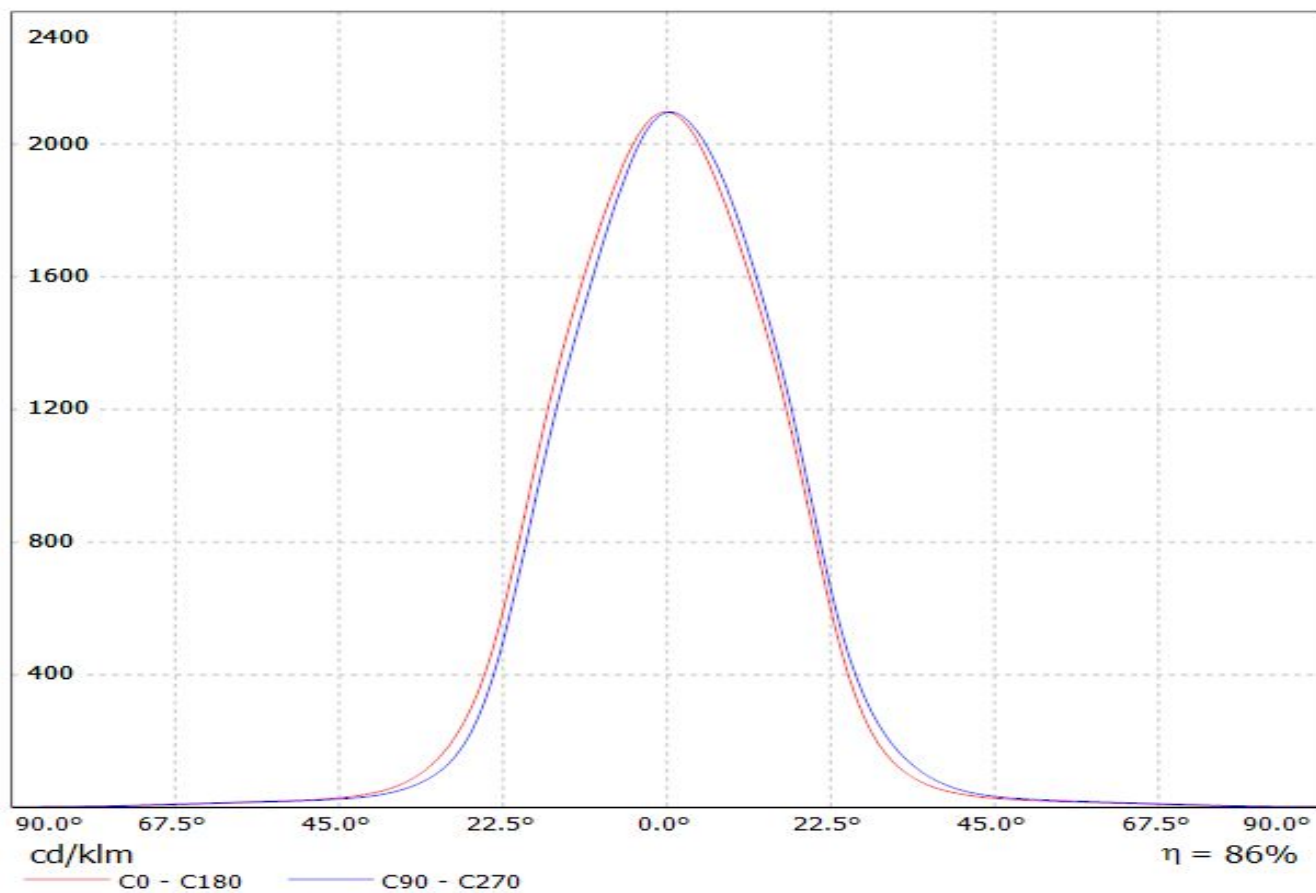

Luminaire: Ledil Oy FP13025_LISA2-W-PIN_(Luxeon_TX) Efficiency=88%
Lamps: 1 x Luxeon TX (L1T2-3585) 82lm @ 250mA CCT= P=0.73W I=250mA

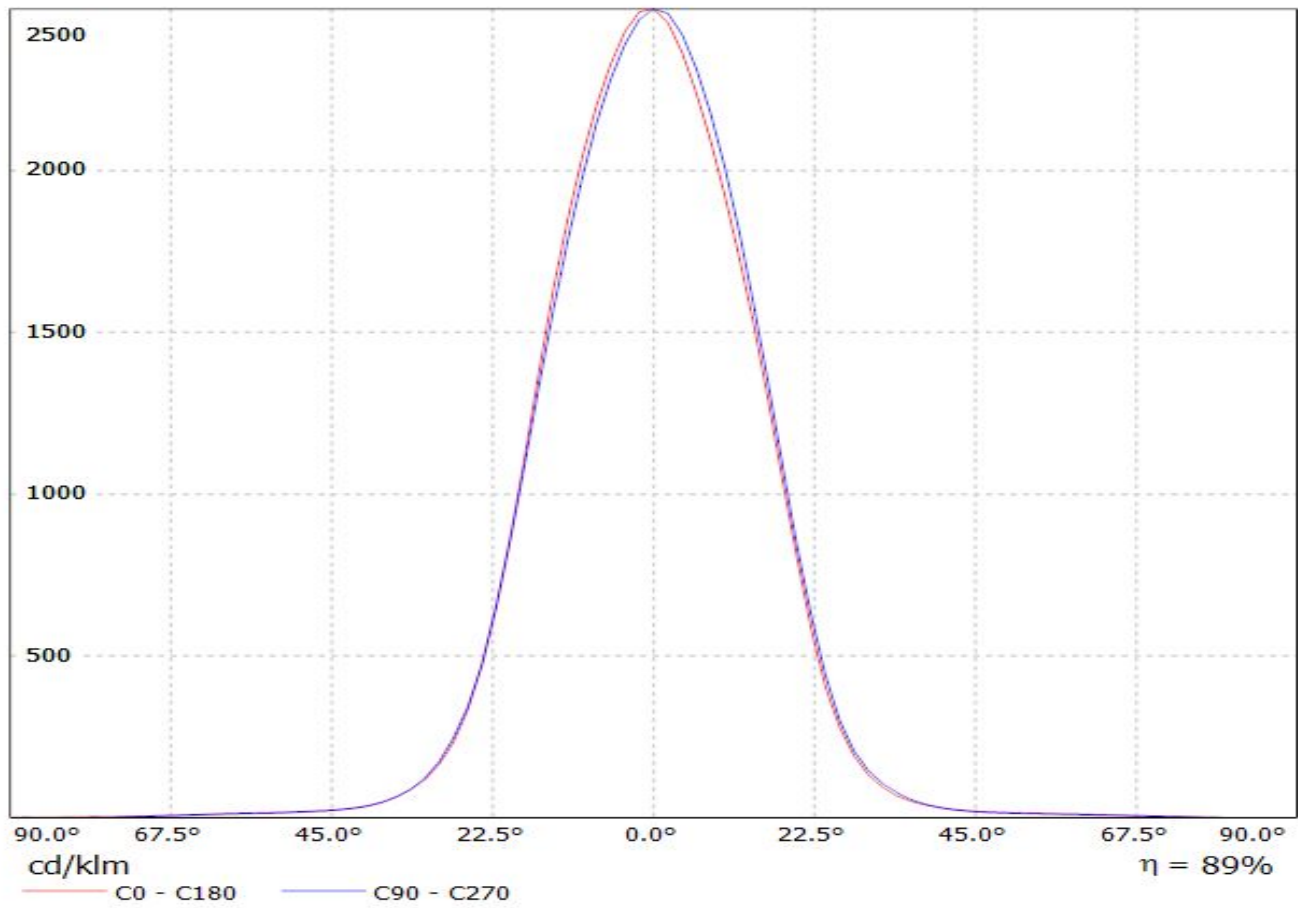

Luminaire: Ledil Oy FP13025&FP13031_LISA2-W Eff. 84%
Lamps: 1 x Nichia NCSxx19B (NCSL119BE) 88lm @ 250mA CCT=3000K P=0.8W I=250mA

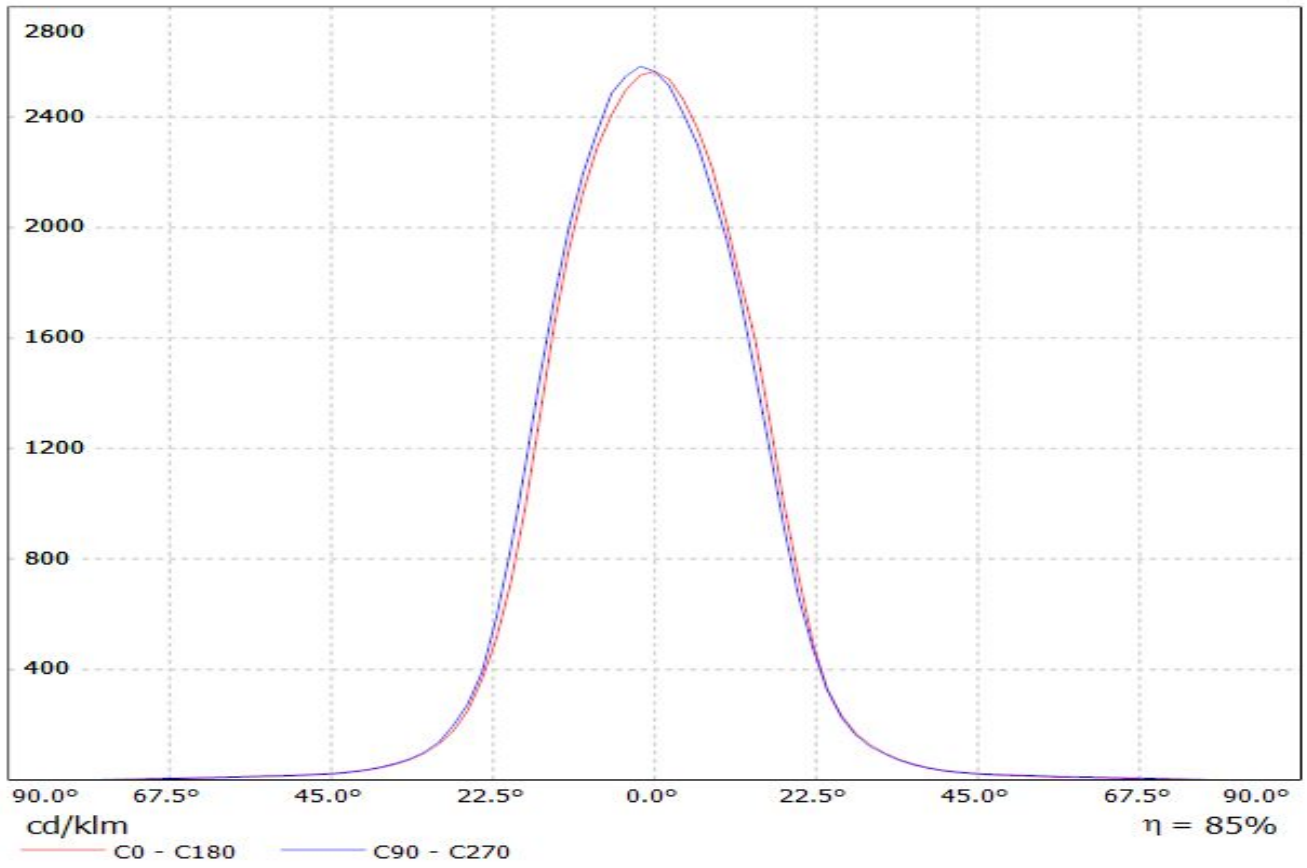

Luminaire: LEDiL Oy FP13025_LISA2-W-PIN_(NVSL219CE)
Lamps: 1 x Nichia_NVSL219CE_101.052lm@250mA_P=0.713154W_I=0.25A

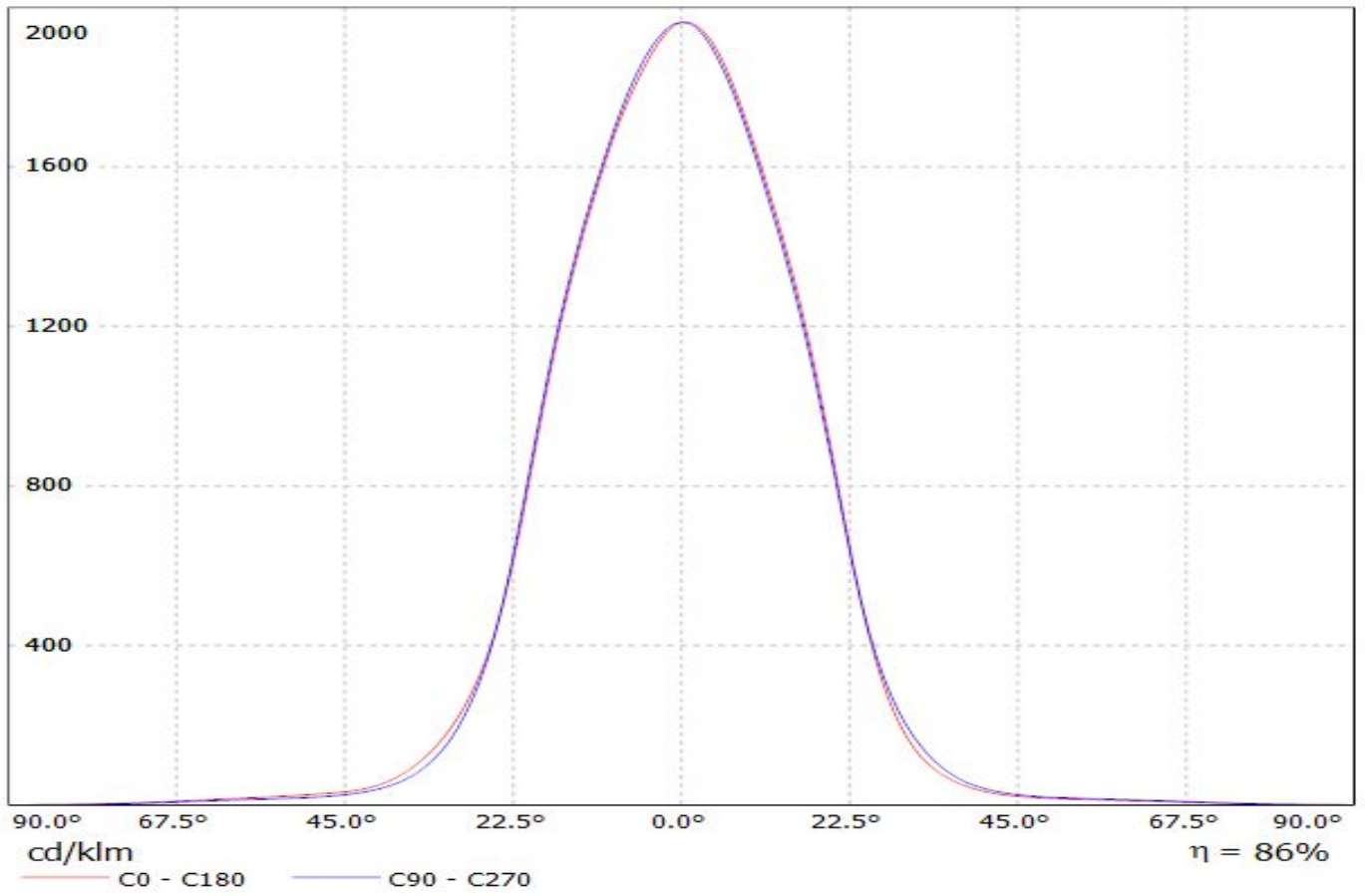

Luminaire: LEDiL Oy
Lamps: 1 x FP13025_LISA2-W-CLIP_(SQ)

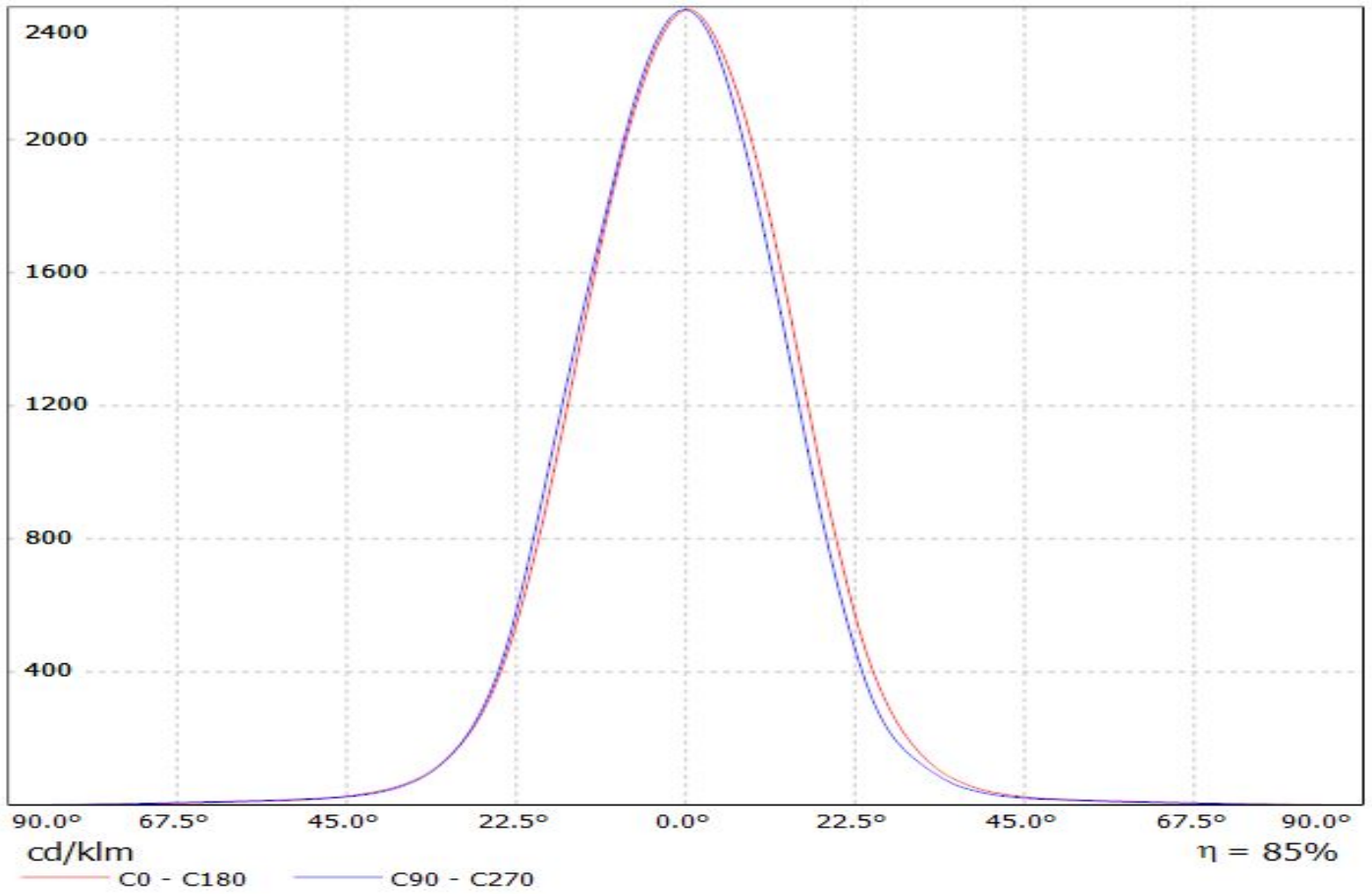

Luminaire: Ledil Oy FP13025_LISA2-W-PIN_(Oslon_Black)_SIMULATED
Lamps: 1 x Osram Oslon Black - LCW H9GP

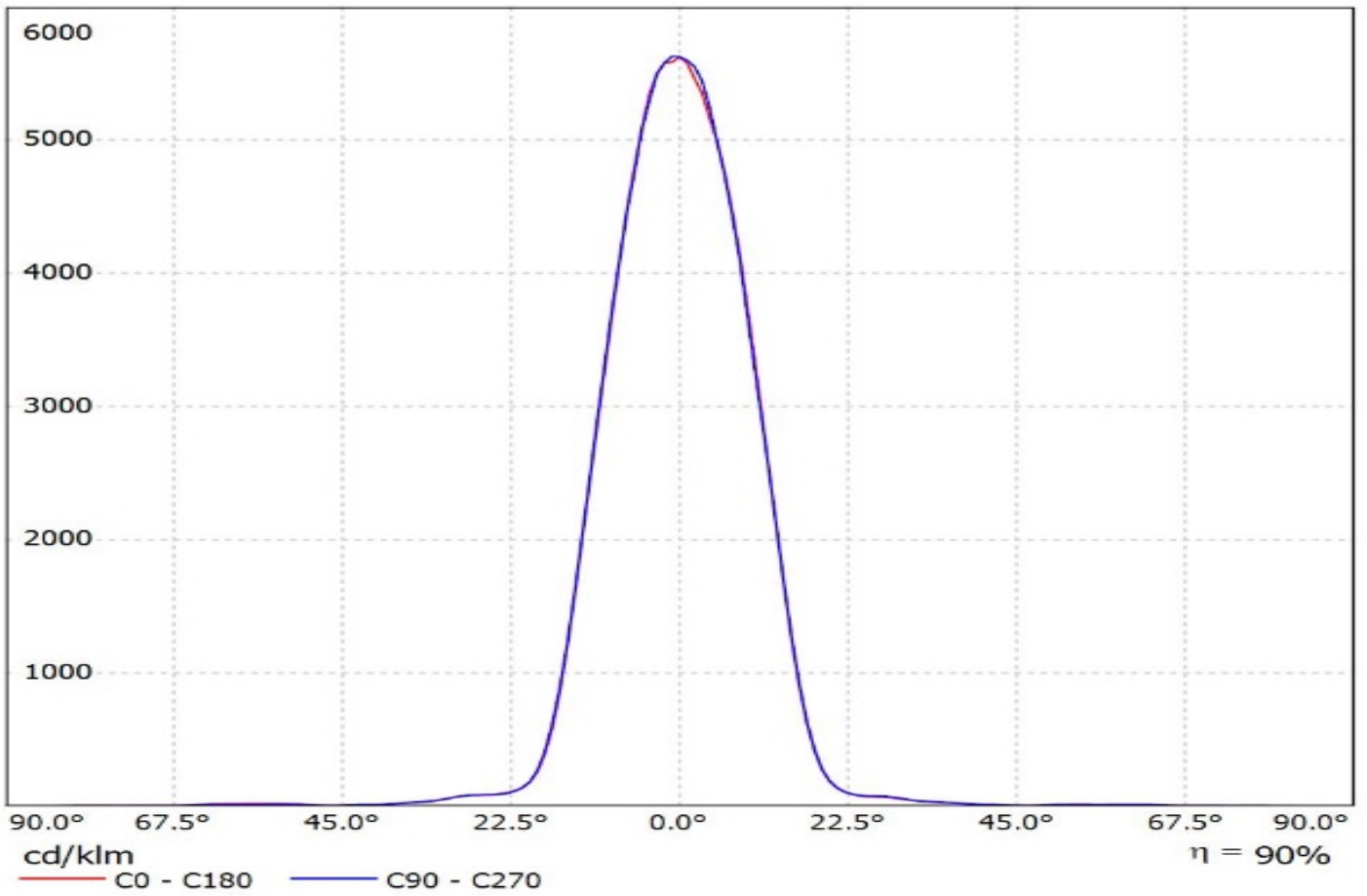

Luminaire: Ledil Oy FP13025_LISA2-W-PIN_(LH351Z) Efficiency=88%
Lamps: 1 x Samsung LH351Z (90.14lm @ 250mA) CCT=6500K P=0.7W I=250mA

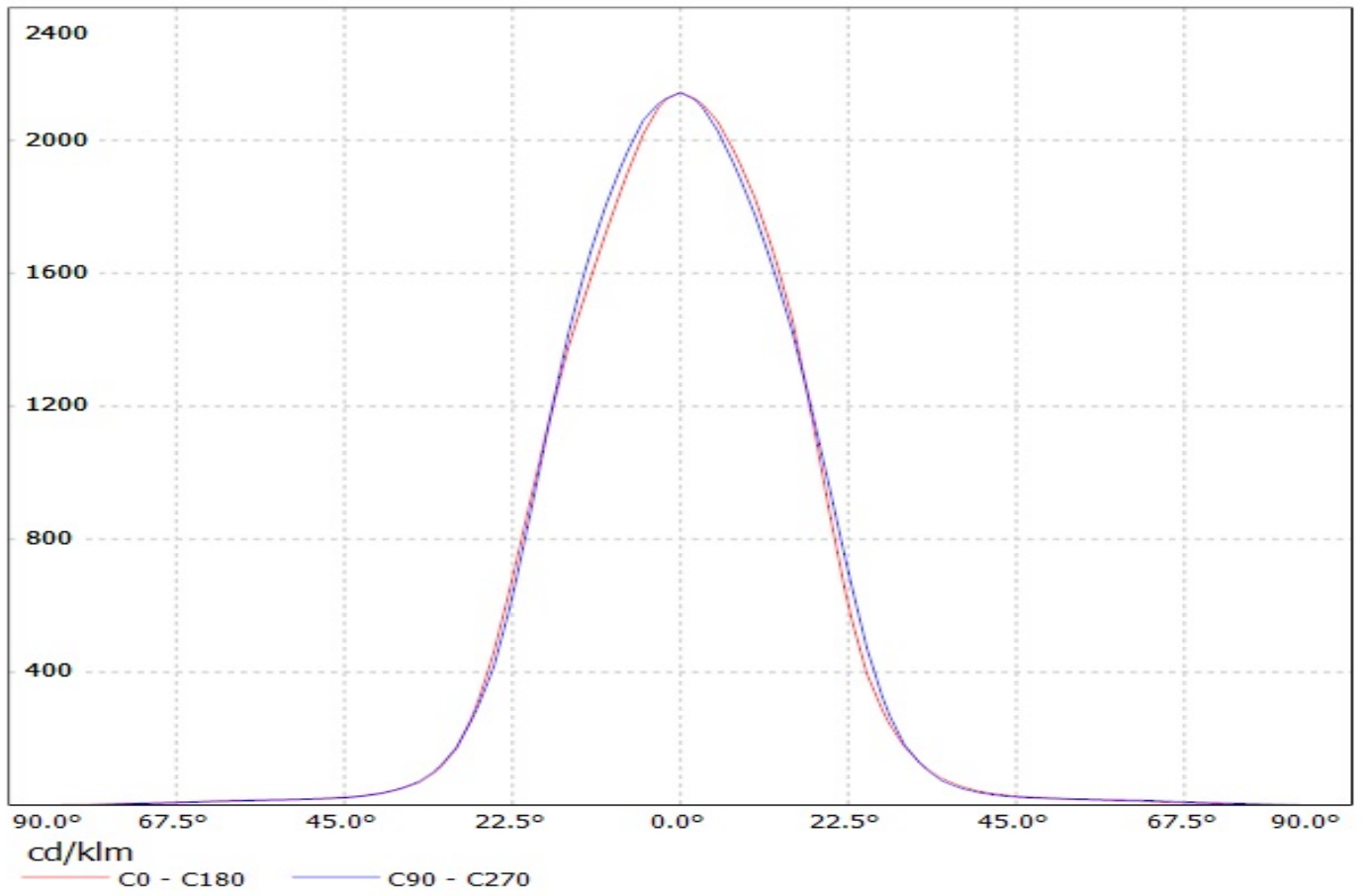

Luminaire: Ledil Oy FP13025_LISA2-W-PIN_Seoul_Z8Y22P_SIMULATED
Lamps: 1 x Seoul Z8Y22P

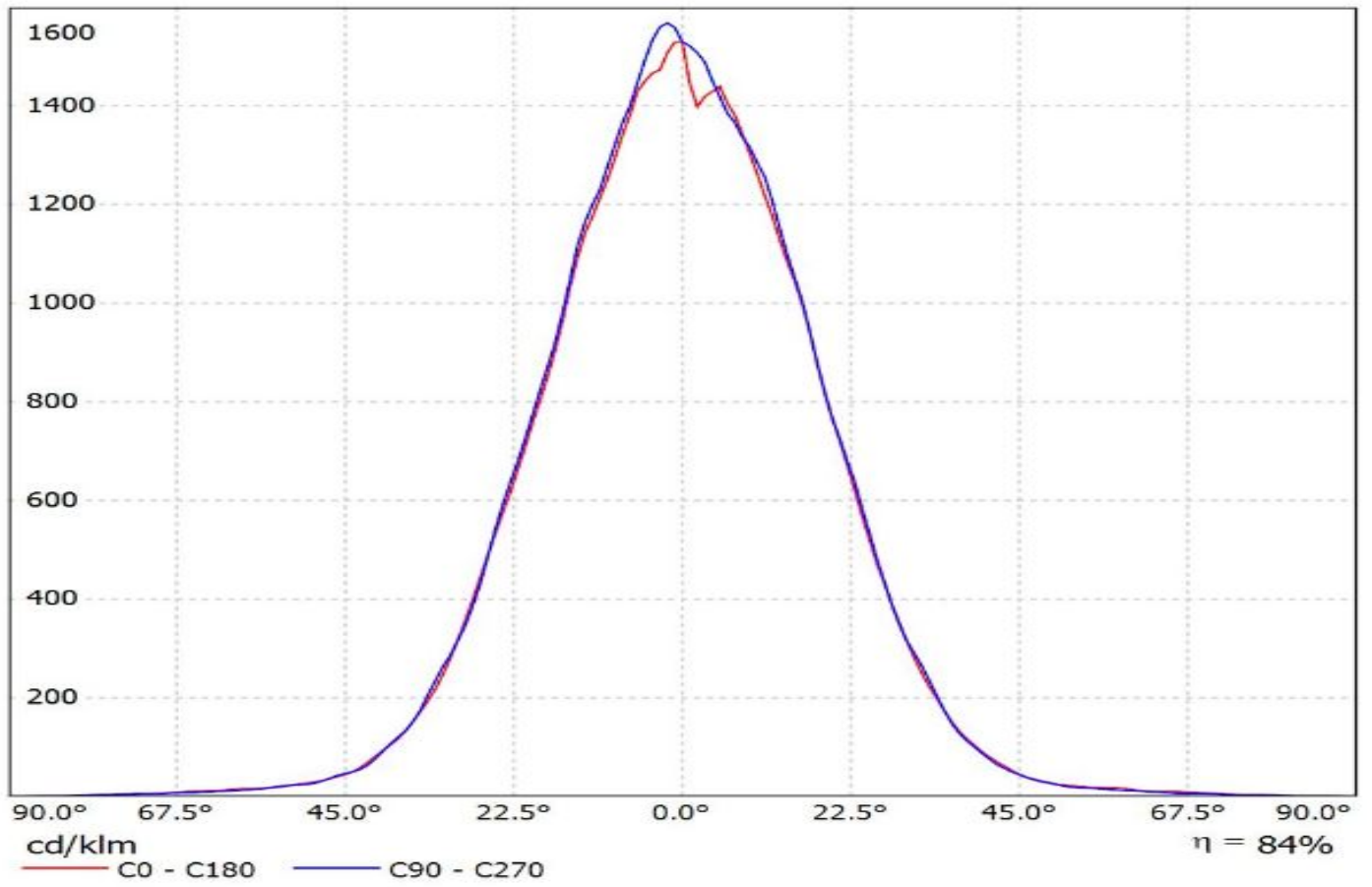

Luminaire: LEDIL OY FP13025_LISA2-W-PIN & FP13031_LISA2-W-CLIP-XTE (Cree XT-E 98lm @ 250mA) Efficiency=84%
Lamps: 1 x CREE XT-E (98.9lm)

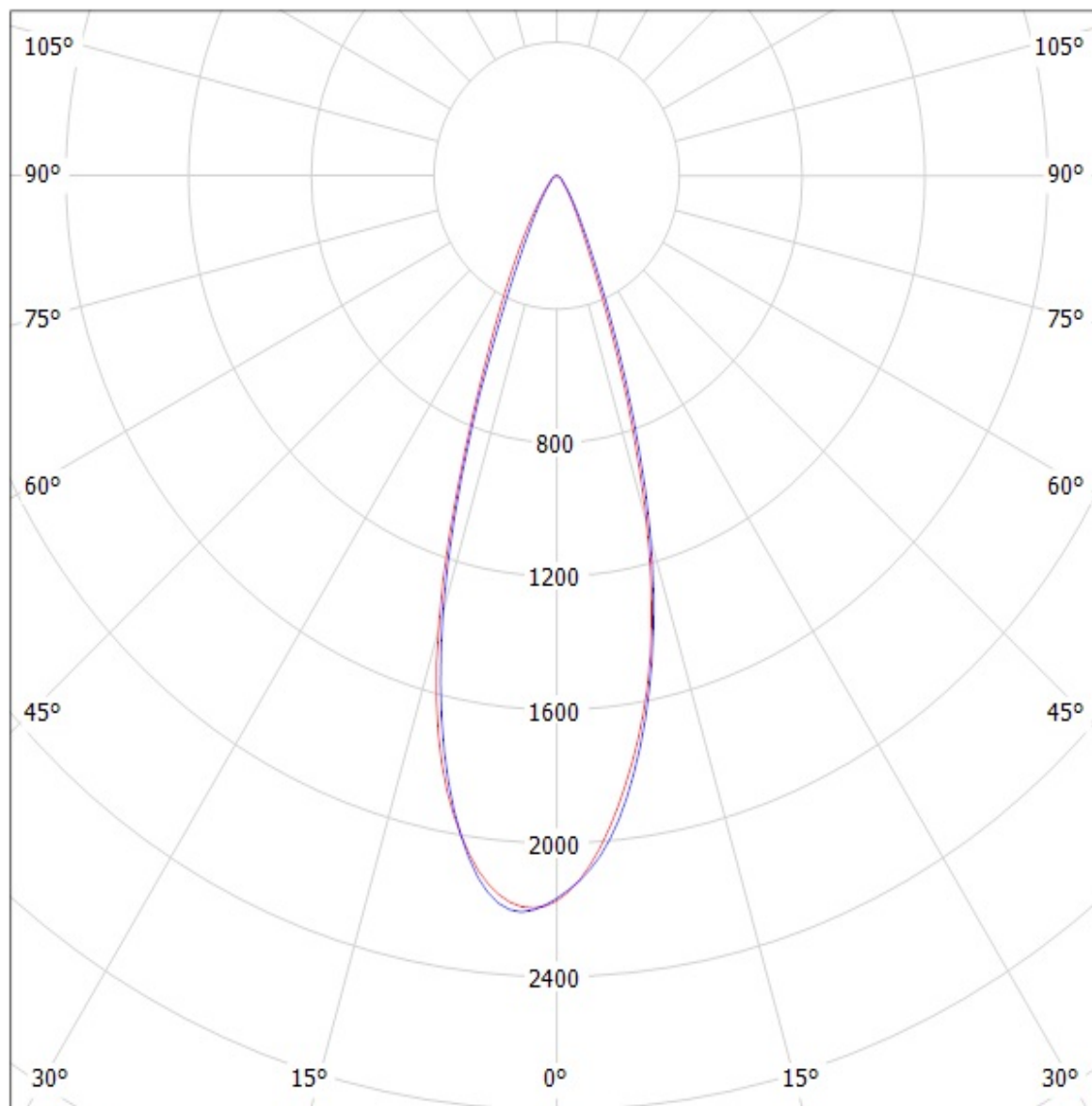

cd/klm

— C0 - C180 — C90 - C270

Luminaire: LEDiL Oy FP13025&FP13031_LISA2-W_(PIN&CLIP)_(XP-G2) Eff.88%
Lamps: 1 x Cree_(XP-G2) 104lm@250mA CCT=6600K P=0.76W I=250mA

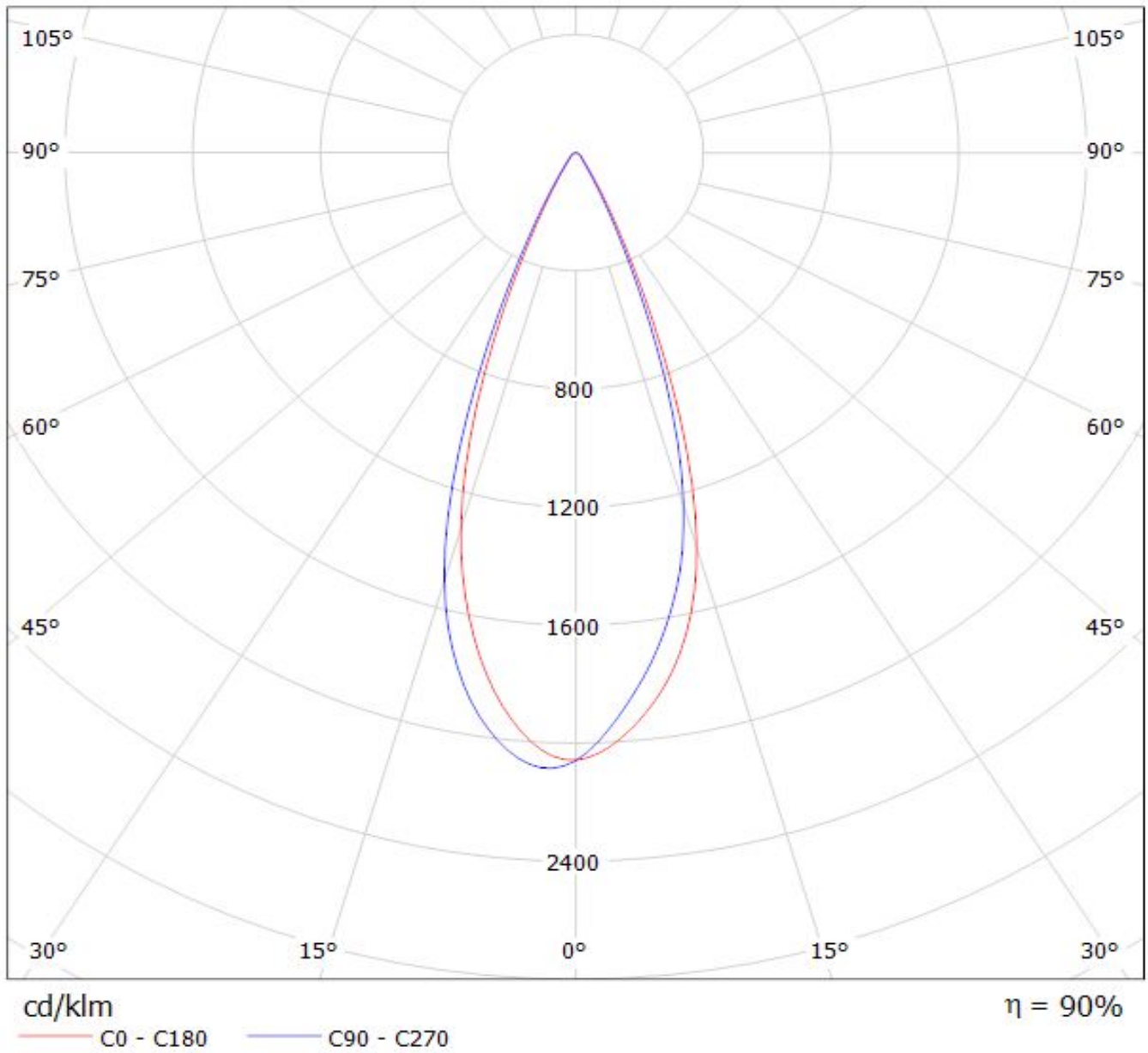

Luminaire: Ledil Oy
Lamps: 1 x

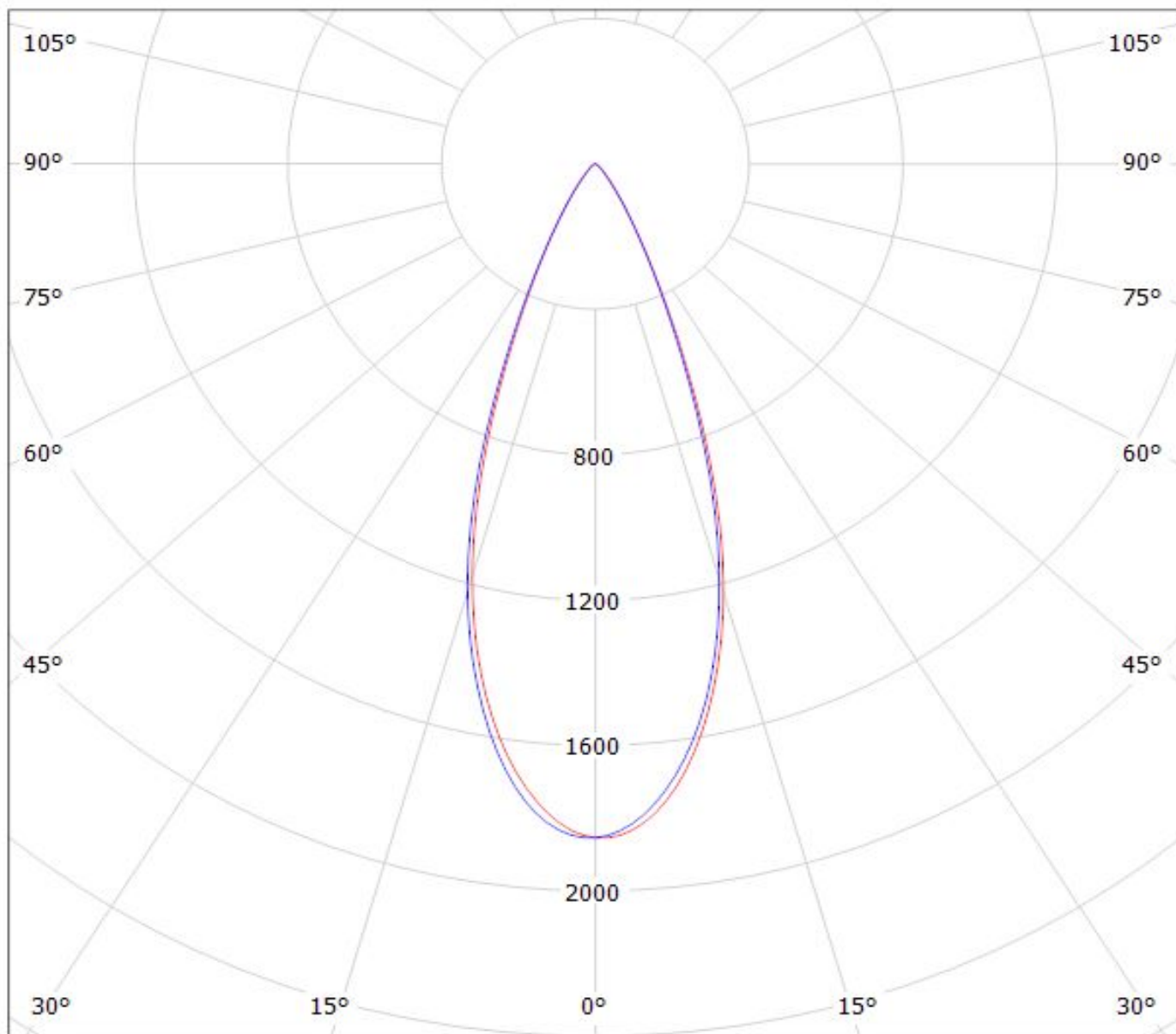

cd/klm

— C0 - C180 — C90 - C270

$\eta = 84\%$

Luminaire: Ledil Oy FP13025_LISA2-W-PIN_(3535_Ceramic_gen2) Efficiency=88%
Lamps: 1 x LG 3535 Ceramic gen2 (PKG5700K) 116lm @ 250mA CCT=6200K P=0.7W I=250mA

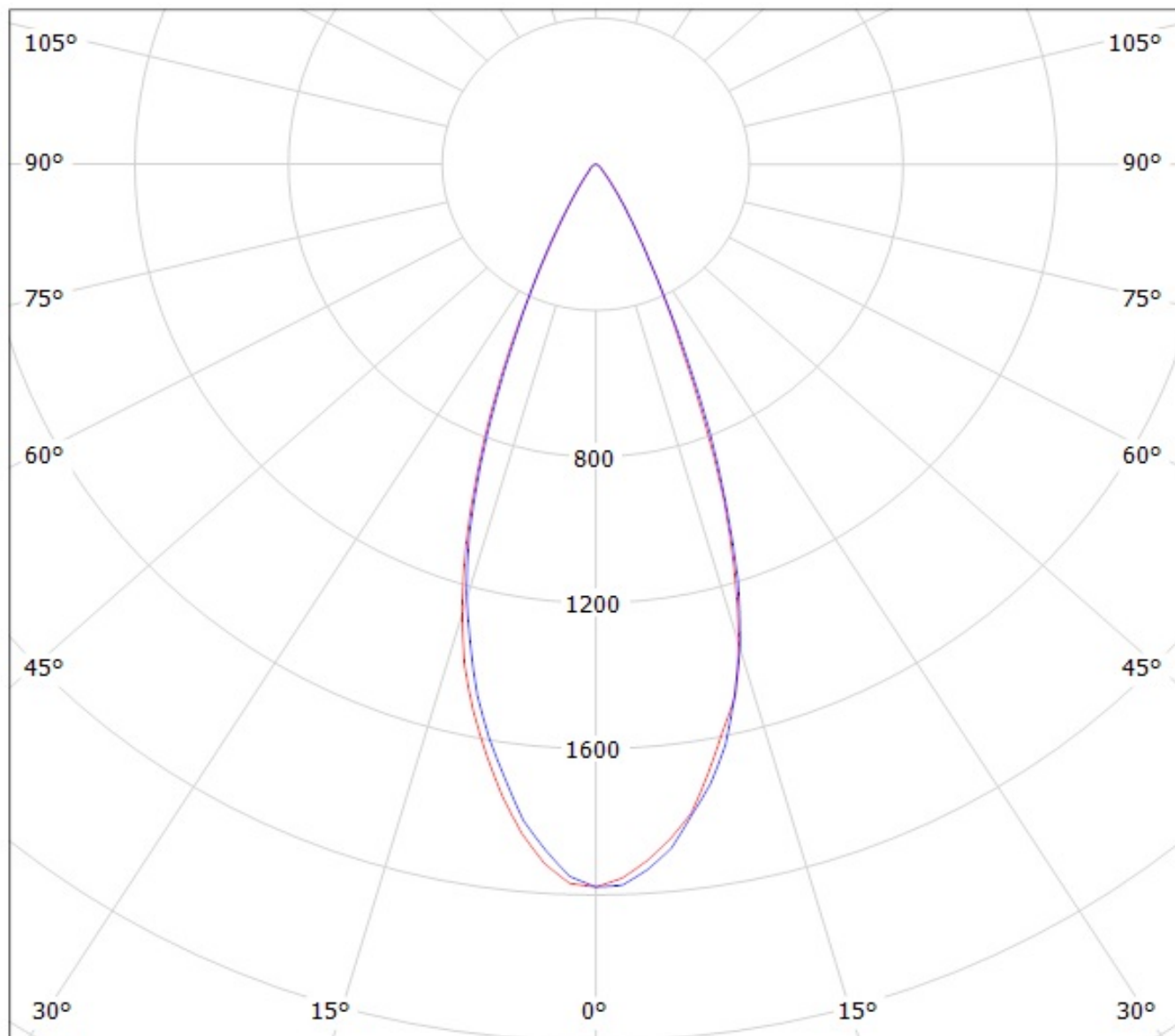

cd/klm

— C0 - C180 — C90 - C270

Luminaire: LEDiL Oy FP13031 & FP13025_LISA2-W_(CLIP/PIN) Eff.86.1%
Lamps: 1 x LUXEON_T (74lm@250mA)

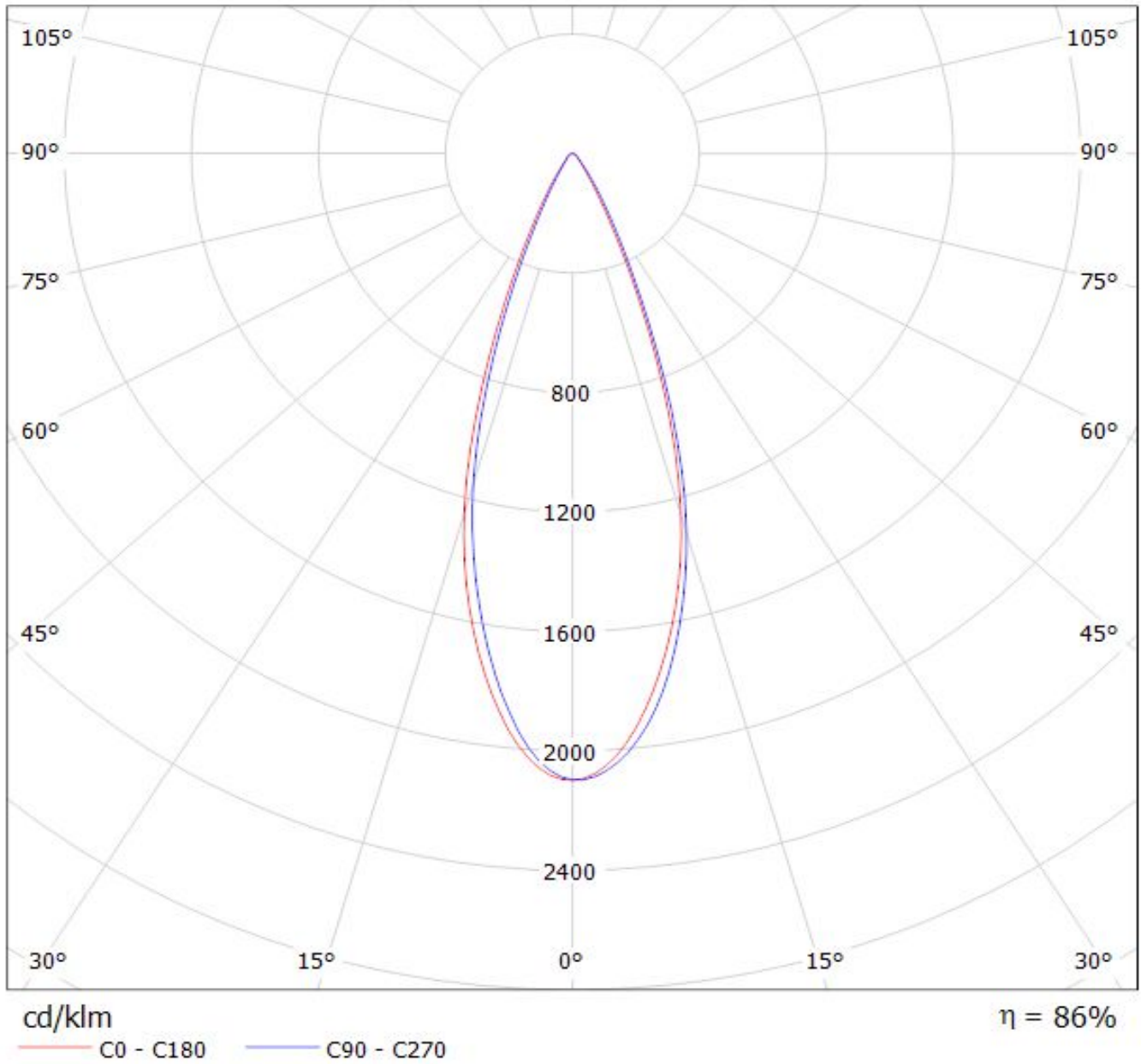

Luminaire: Ledil Oy FP13025_LISA2-W-PIN_(Luxeon_TX) Efficiency=88%
Lamps: 1 x Luxeon TX (L1T2-3585) 82lm @ 250mA CCT= P=0.73W I=250mA

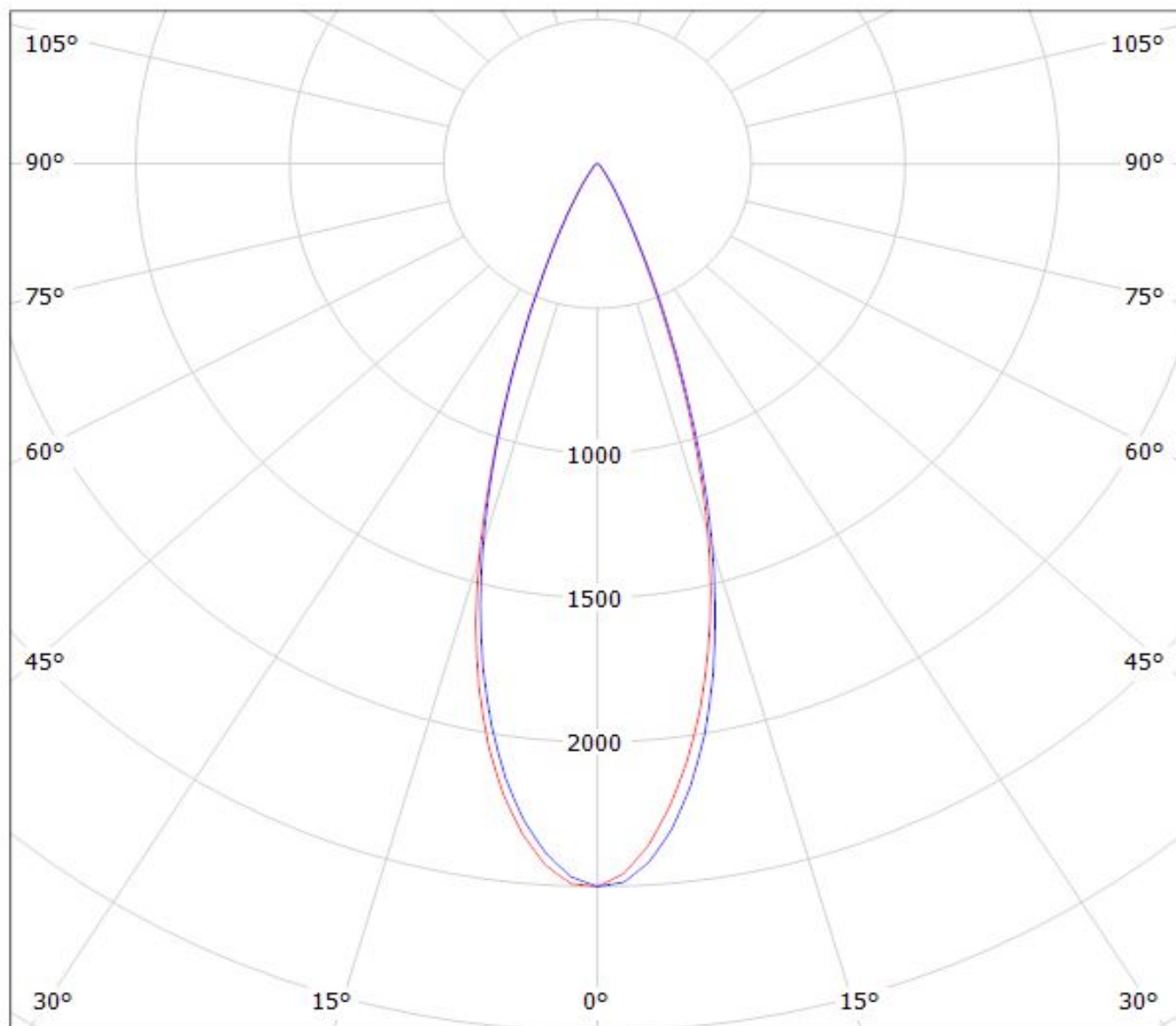

cd/klm

— C0 - C180

— C90 - C270

$\eta = 89\%$

Luminaire: Ledil Oy FP13025&FP13031_LISA2-W Eff. 84%

Lamps: 1 x Nichia NCSxx19B (NCSL119BE) 88lm @ 250mA CCT=3000K P=0.8W I=250mA

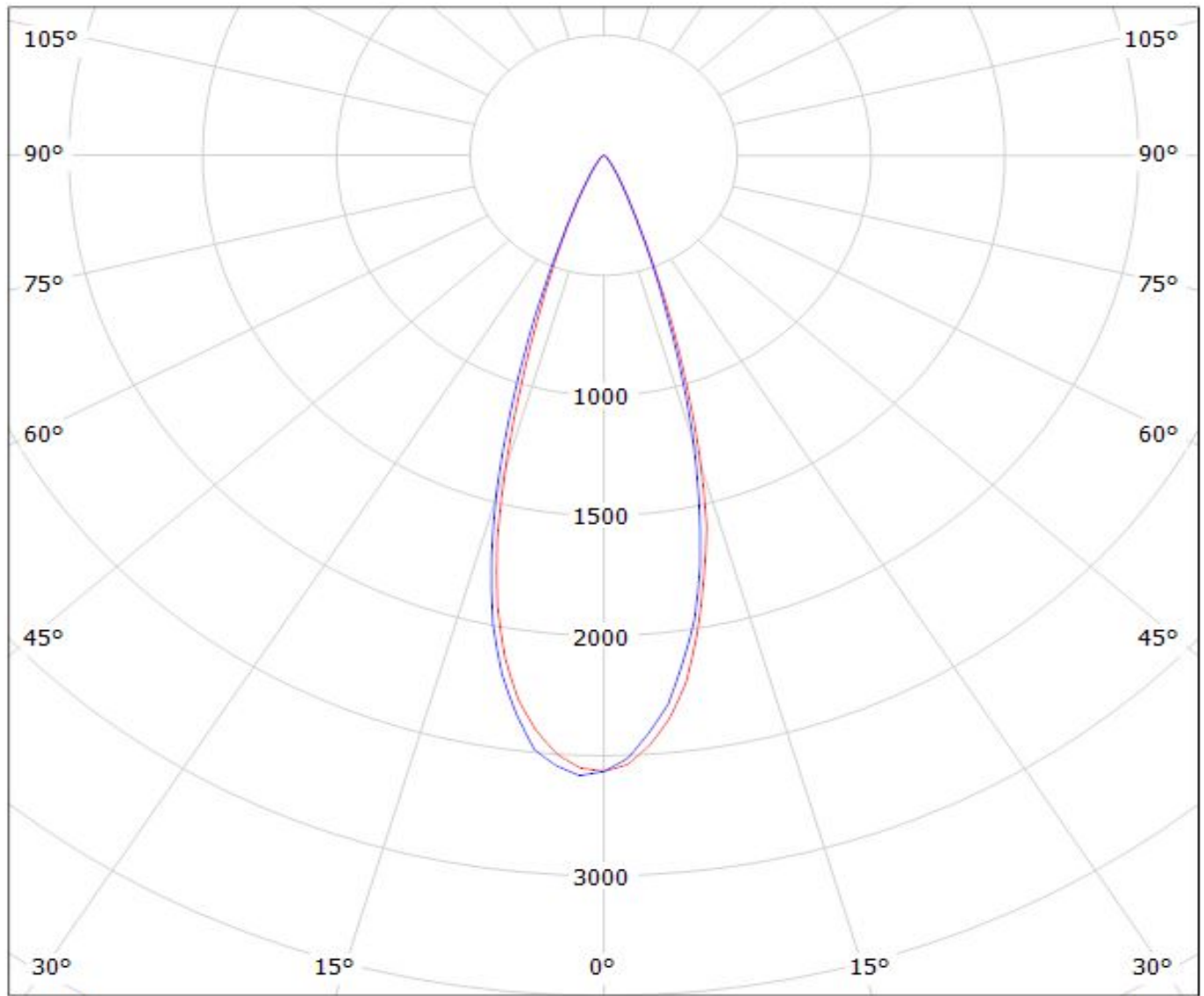

cd/klm

— C0 - C180

— C90 - C270

$\eta = 85\%$

Luminaire: LEDiL Oy FP13025_LISA2-W-PIN_(NVSL219CE)

Lamps: 1 x Nichia_NVSL219CE_101.052lm@250mA_P=0.713154W_I=0.25A

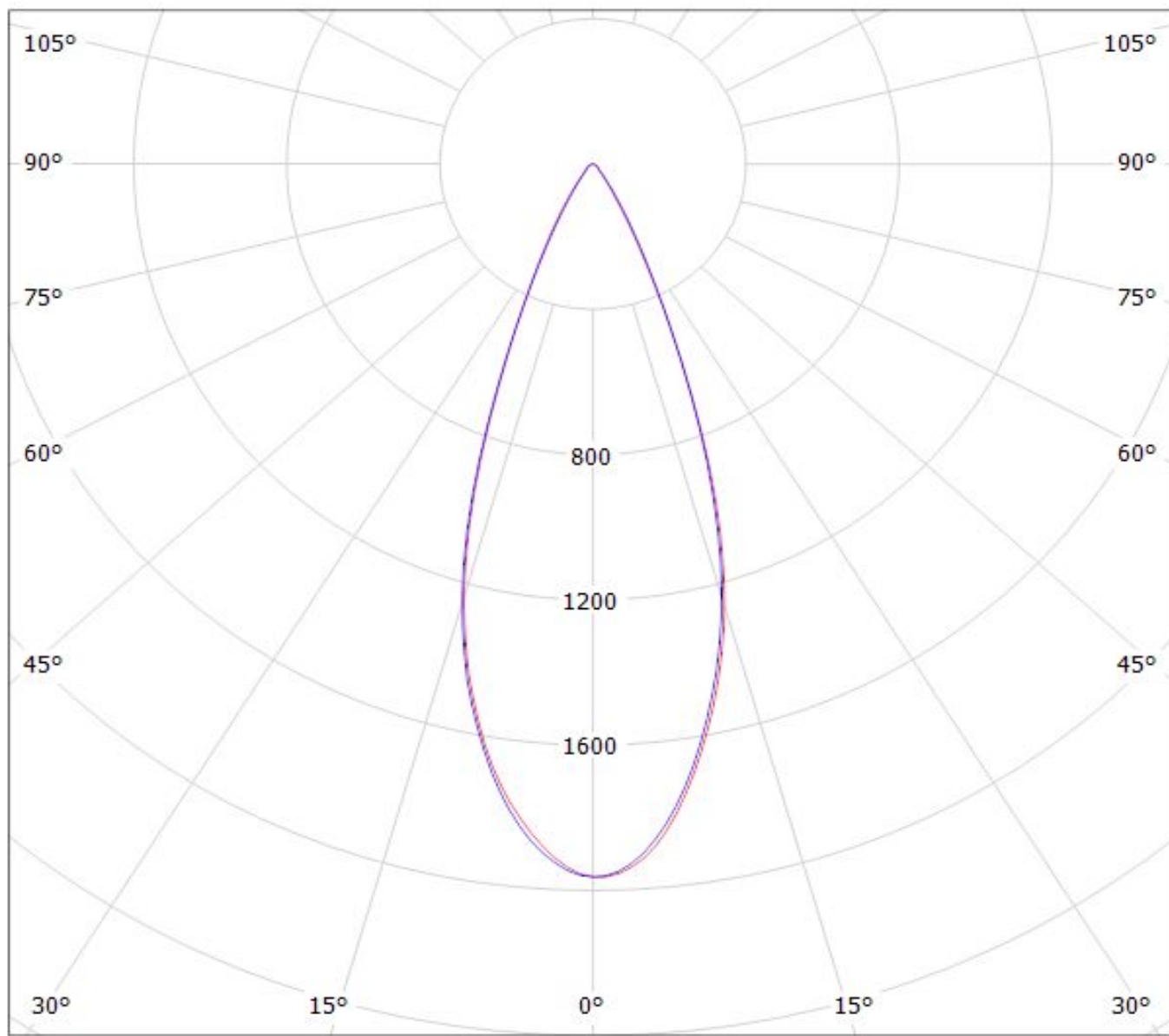

cd/klm

$\eta = 86\%$

— C0 - C180

— C90 - C270

Luminaire: LEDiL Oy
Lamps: 1 x FP13025_LISA2-W-CLIP_(SQ)

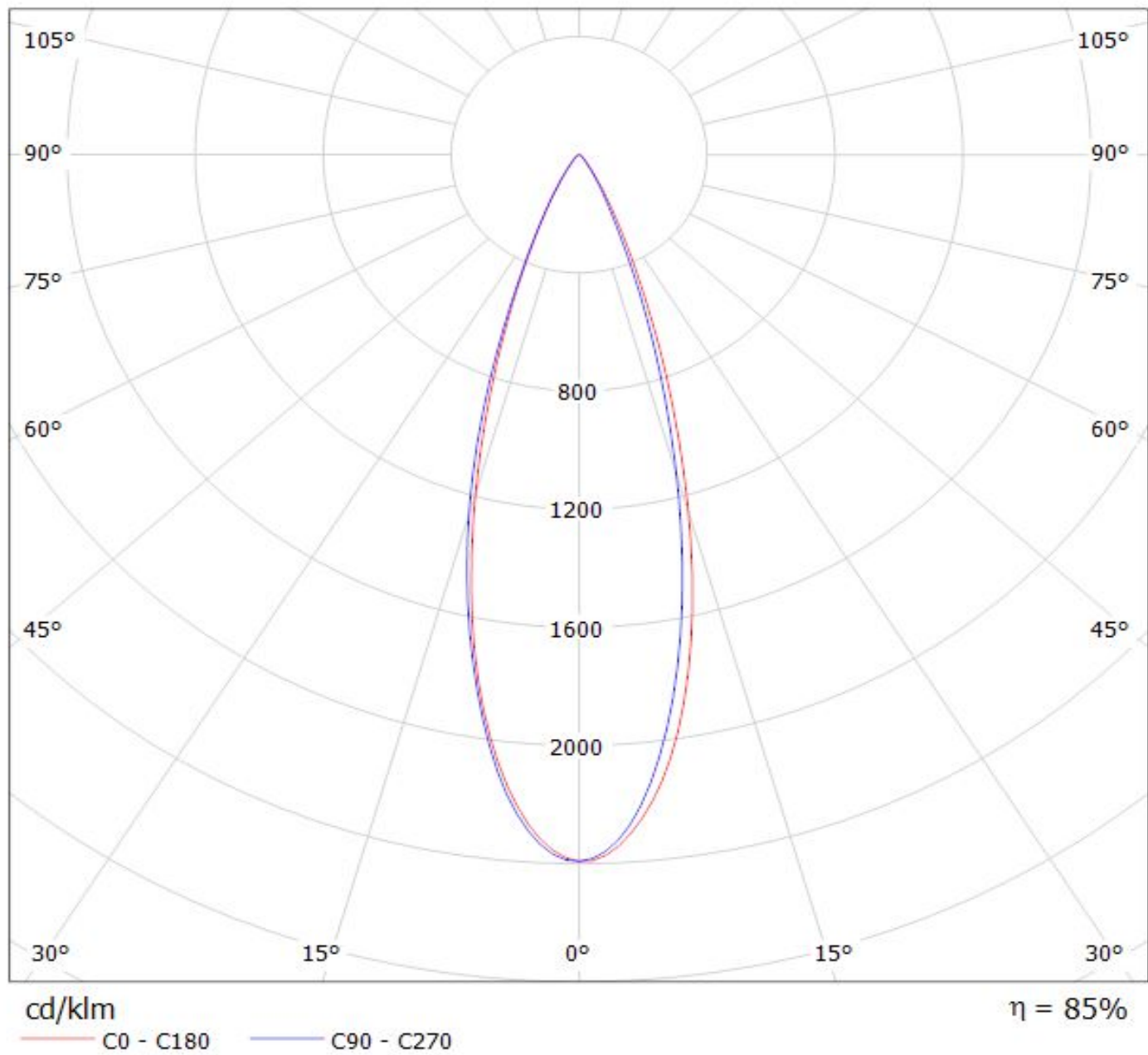

Luminaire: Ledil Oy FP13025_LISA2-W-PIN_(Oslon_Black)_SIMULATED
Lamps: 1 x Osram Oslon Black - LCW H9GP

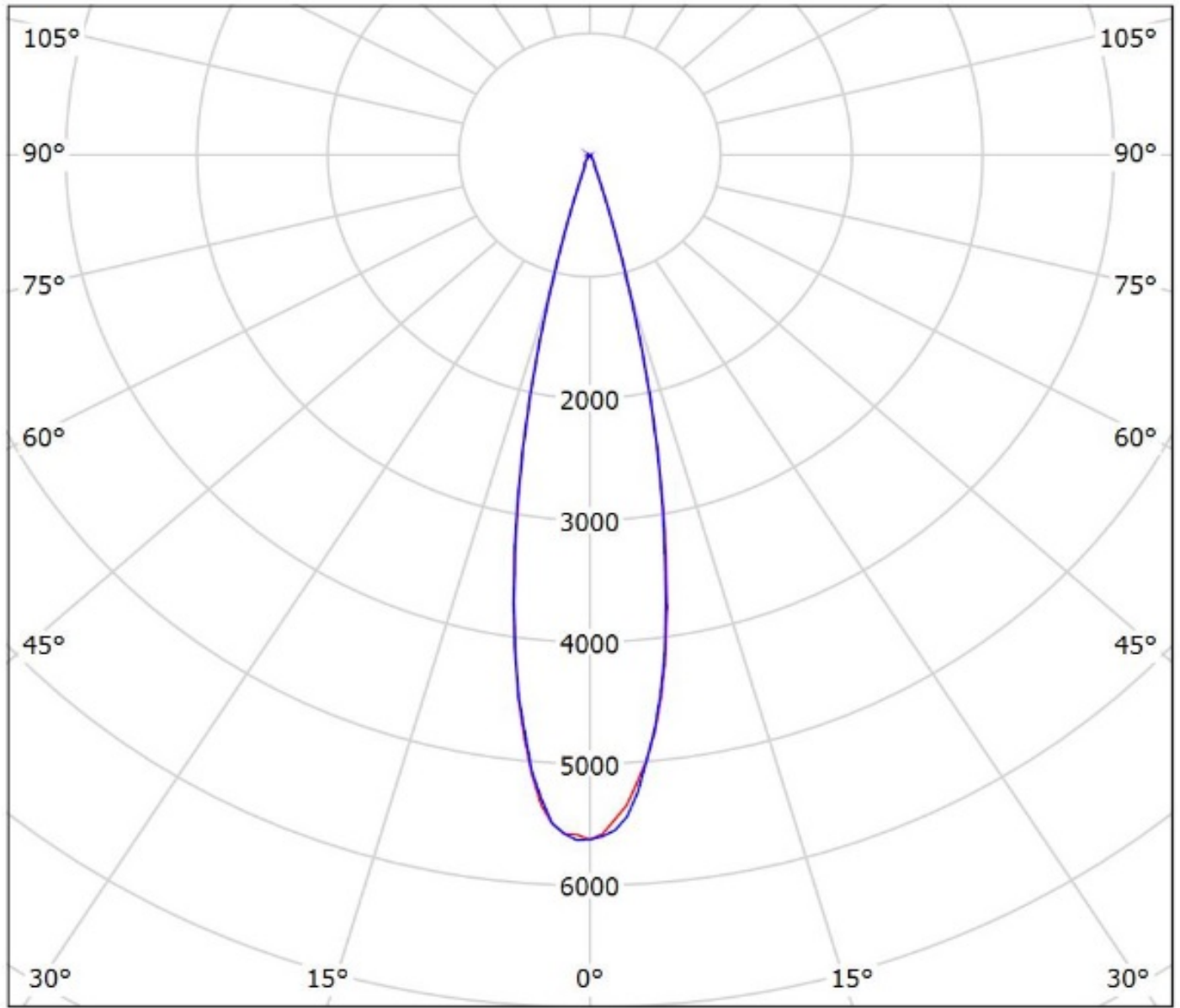

cd/klm
— C0 - C180 — C90 - C270

η = 90%

Luminaire: Ledil Oy FP13025_LISA2-W-PIN_(LH351Z) Efficiency=88%
Lamps: 1 x Samsung LH351Z (90.14lm @ 250mA) CCT=6500K P=0.7W I=250mA

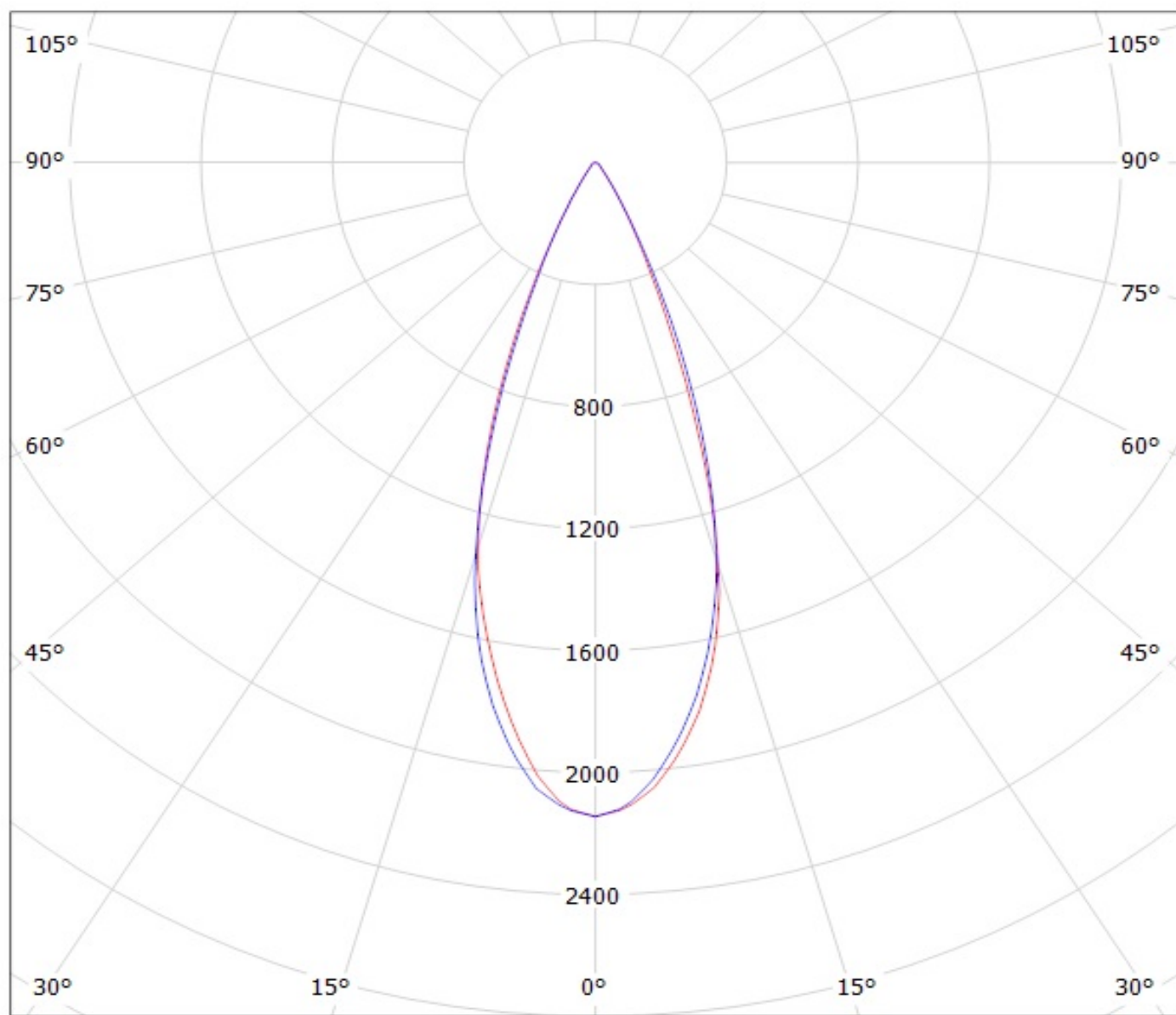

cd/klm

— C0 - C180

— C90 - C270

Luminaire: Ledil Oy FP13025_LISA2-W-PIN_Seoul_Z8Y22P_SIMULATED

Lamps: 1 x Seoul Z8Y22P

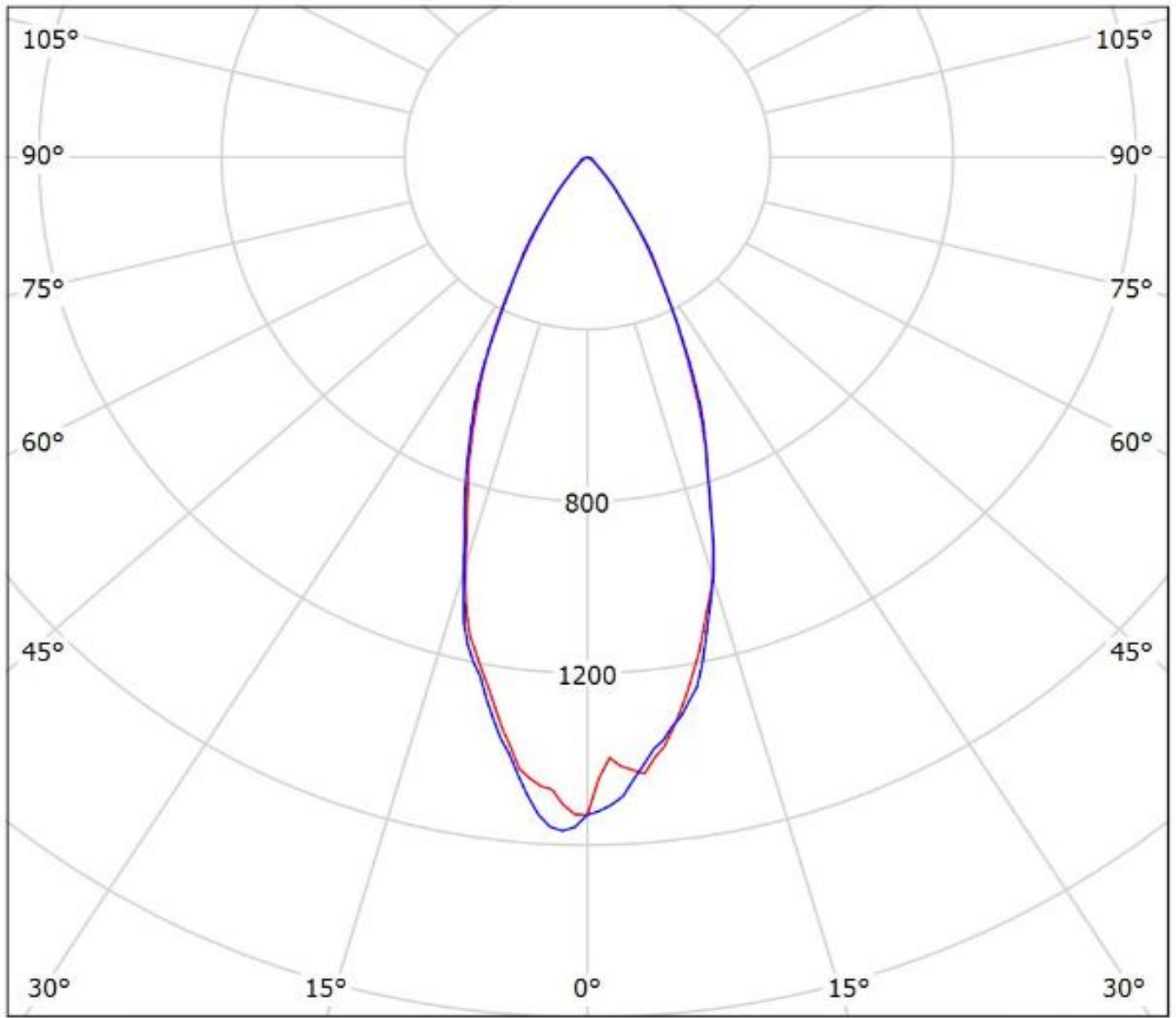

cd/klm

— C0 - C180 — C90 - C270

$\eta = 84\%$

NOTE: The typical divergence will be changed by different color, chip size and chip position tolerance. The typical total divergence is the full angle measured where the luminous intensity is half of the peak value.