

CCA 2,5/ 6-G-5,08 P26THRR56

Order No.: 1955073

<http://eshop.phoenixcontact.de/phoenix/treeViewClick.do?UID=1955073>

Header, Nominal current: 12 A, Rated voltage (III/2): 320 V,
Number of positions: 6, Pitch: 5.08 mm, Color: black, Metal surface:
Sn, Assembly: SMD/THT/THR, User information and design
recommendations on through hole reflow technology can be found at:
<http://www.combicon.com>

Commercial data

GTIN (EAN)	 4 017918 925888
Note	Made-to-order
sales group	E172
Pack	330 pcs.
Customs tariff	85366990
Catalog page information	Page 239 (CC-2009)

Product notesWEEE/RoHS-compliant since:
01/01/2003

<http://www.download.phoenixcontact.com>
Please note that the data given here has been taken from the online catalog. For comprehensive information and data, please refer to the user documentation. The General Terms and Conditions of Use apply to Internet downloads.

Technical data**Dimensions / positions**

Length	12 mm
Pitch	5.08 mm

Dimension a	25.4 mm
Number of positions	6
Pin dimensions	1 x 1 mm
Pin spacing	5.08 mm
Hole diameter	1.6 mm

Technical data

Range of articles	CCA 2,5/...-G
Insulating material group	IIIa
Rated surge voltage (III/3)	4 kV
Rated surge voltage (III/2)	4 kV
Rated surge voltage (II/2)	4 kV
Rated voltage (III/2)	320 V
Rated voltage (II/2)	400 V
Connection in acc. with standard	EN-VDE
Nominal current I_N	12 A
Nominal voltage U_N	250 V
Maximum load current	12 A (per position)
Insulating material	LCP
Inflammability class acc. to UL 94	V0
Nominal voltage, UL/CUL Use Group B	250 V
Nominal current, UL/CUL Use Group B	10 A
Nominal voltage, UL/CUL Use Group D	300 V
Nominal current, UL/CUL Use Group D	10 A

Certificates / Approvals



Certification

CUL, UL

Accessories

Item	Designation	Description
General		
1954362	CR-MSTB NAT HT	HT keying section, prior to the reflow soldering process it is inserted into the recess on the header, made from high-temperature-resistant beige insulation material
Marking		
1051993	B-STIFT	Marker pen, for manual labeling of unprinted Zack strips, smear-proof and waterproof, line thickness 0.5 mm
0804303	SK 5,08/3,8: 0-9	Marker card, printed horizontally, self-adhesive, 10-section marker strip, 12 identical decades marked 0-9, sufficient for 120 terminal blocks
0804293	SK 5,08/3,8:FORTL.ZAHLEN	Marker card, printed horizontally, self-adhesive, 12 identical decades marked 1-10, 11-20 etc. up to 91-(99)100, sufficient for 120 terminal blocks
0805085	SK 5,08/3,8:SO	Marker card, special printing, self-adhesive, labeled acc. to customer requirements, 12 identical marker strips per card, max. 25-position labeling per strip, color: white
0805412	SK 5,08/3,8:UNBEDRUCKT	Marker cards, unprinted, with pitch divisions, self-adhesive, 10-section marker strips, 12 strips per card, can be labeled with the M-PEN
Plug/Adapter		
1734401	CR-MSTB	Coding section, inserted into the recess in the header or the inverted plug, red insulating material

Diagrams/Drawings

Drilling plan/solder pad geometry

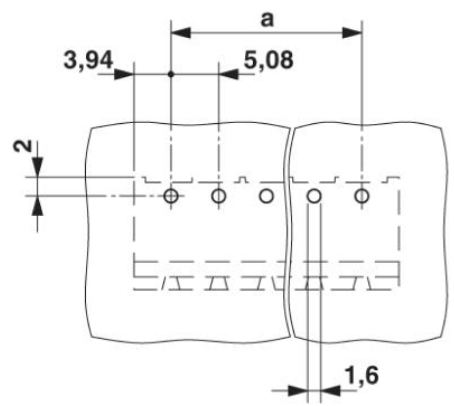

Dimensioned drawing

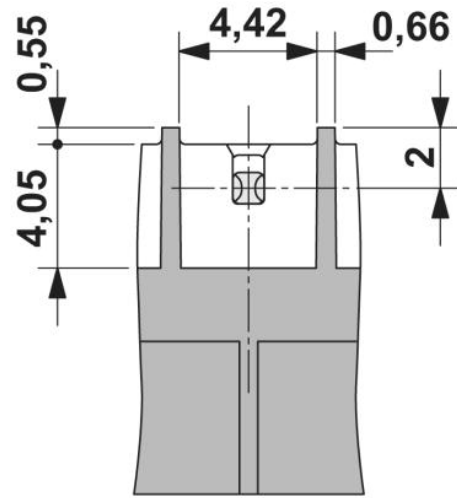
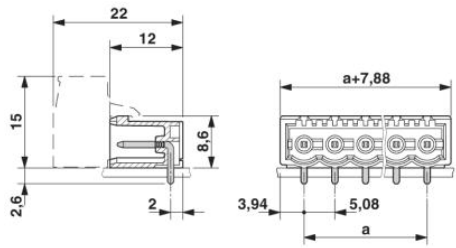

Bottom view, free space for solder paste,
0.5 mm deep

Direction of the arrow = feeding direction

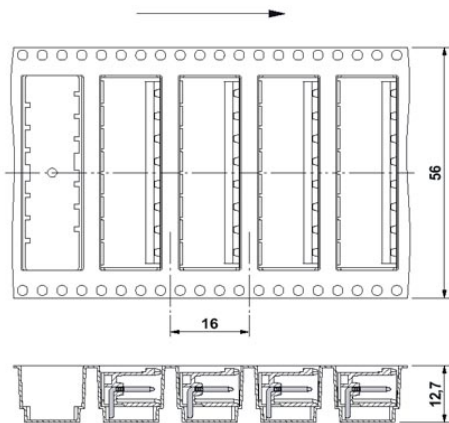

Address

PHOENIX CONTACT Deutschland GmbH
Flachmarktstr. 8
32825 Blomberg, Germany
Phone +49 5235 3 12000
Fax +49 5235 3 41200
<http://www.phoenixcontact.de>



© 2010 Phoenix Contact
Technical modifications reserved;