

Vision Sensor FZ4 Series

Keep on Evolving to the top of Image Sensing



» Speed evolution by Quad Processing

» Shape Search II : Cutting edge algorithm for search evolution

Keep on Evolving

Speed and accuracy determine the basic performance of sensing. Usability efficiently puts that performance to work. OMRON's FZ Series of Vision Sensors represent an evolutionary journey that takes these three aspects from the past and into the future to allow you to increase quality.

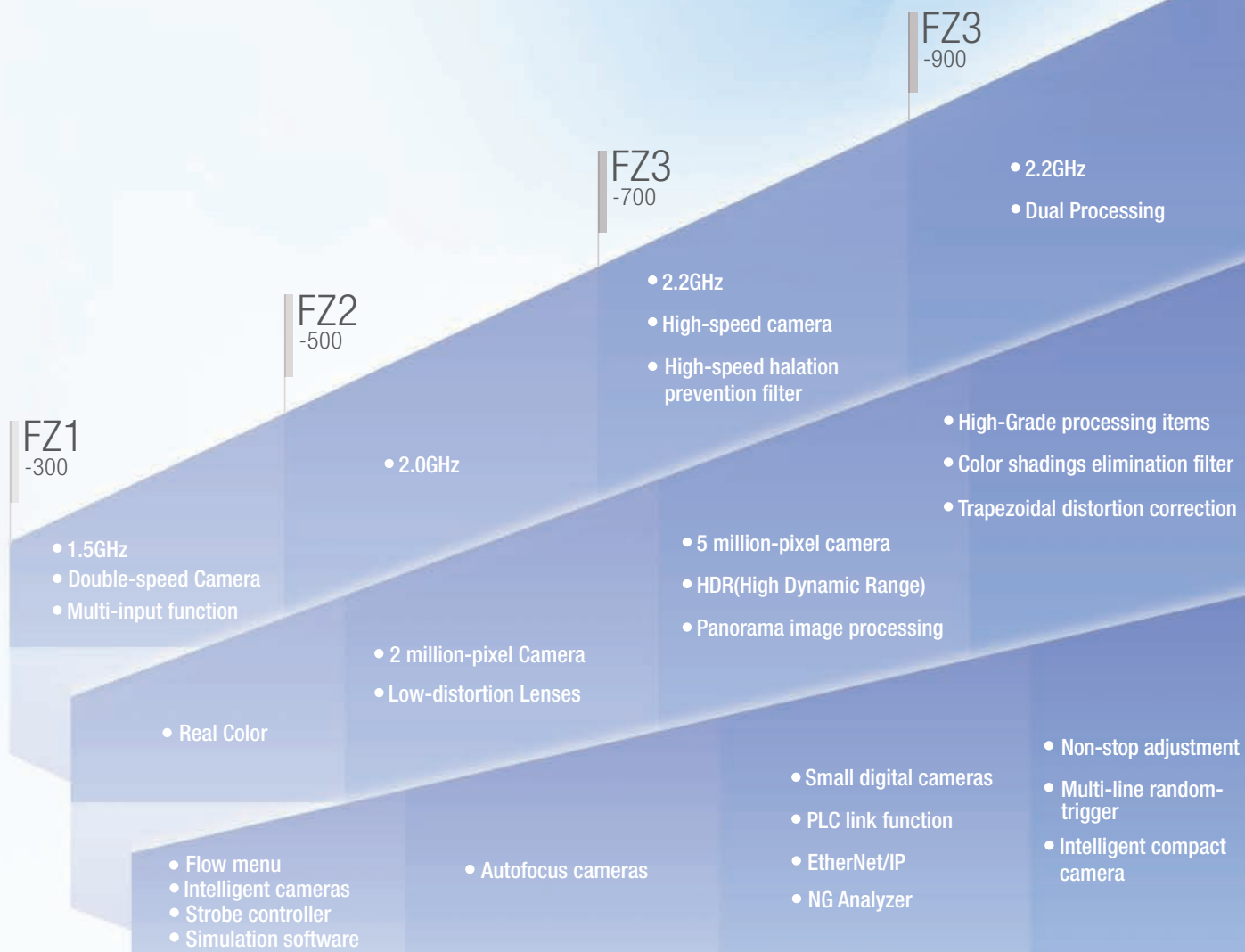



FZ4 -1100

Class No.1 speed

- Quad Processing
- 2.4GHz

➤ P4



Speed

Greatest Detection Class No.1 speed

- Shape Search II

➤ P6

Image Filters

- Brightness Correct Filter
- Stripe Removal Filter II
- Precise Calibration

➤ P18



Accuracy

Utility

- Remote Operation
- User Data

➤ P11

➤ P13



Usability

Class No.1 speed

Quad Processing

Single processing led to dual processing, and now the FZ4 takes evolution one step farther with quad processing featuring multi-core, multi-thread operation. Parallel execution of the process flow is automatically calculated to achieve optimum allocation of tasks according to the processor load to achieve the fastest processing in this class. The rapidly-evolving Intel® processors are used. Performance is maximized with a unique software structure that is matched to the processors.

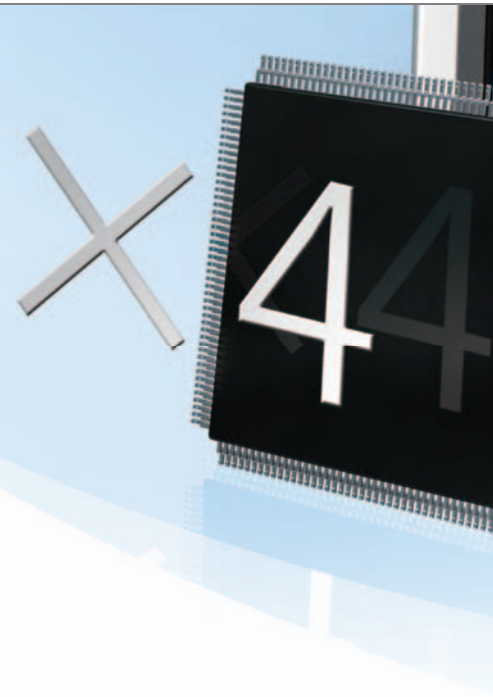

Four-track Parallel Processing

Software that has been designed specifically for quad processing automatically determines the faster processing scheme. Maximum speed has been achieved even for High-resolution Cameras and search processing, both of which place a high load on the system.

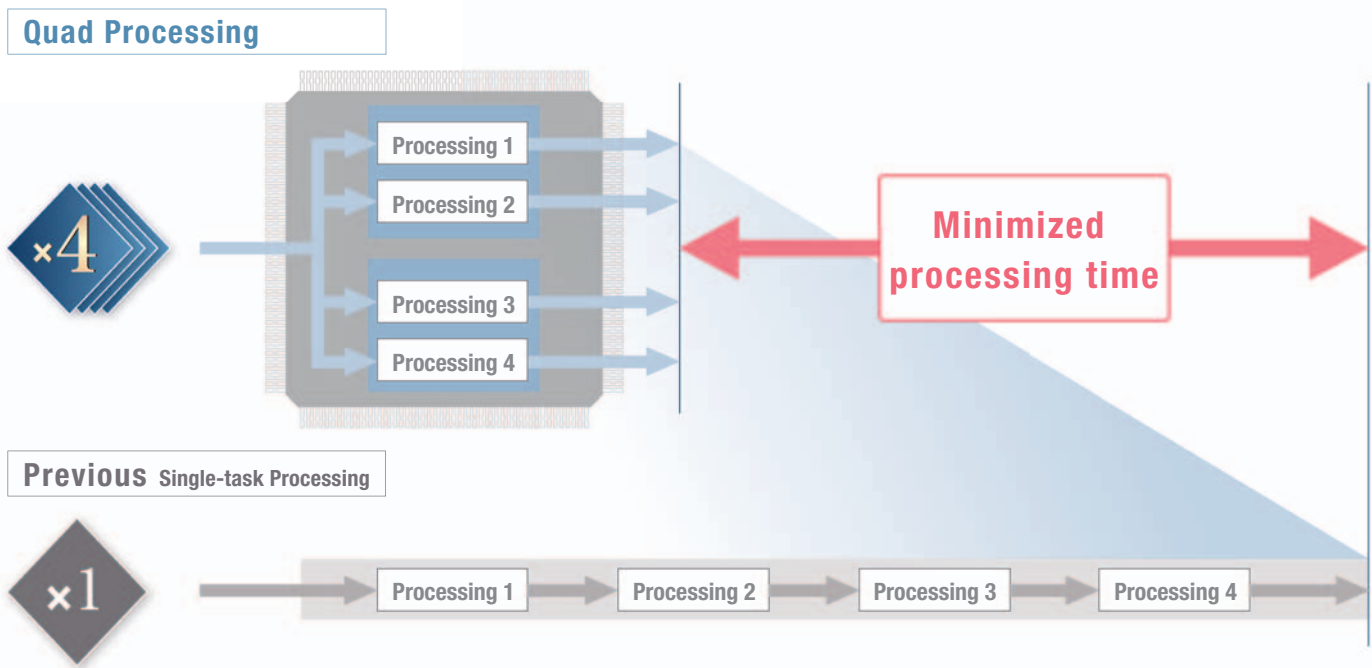

Example of Faster Operation with Quad Processing

The optimum processing scheme to minimize the time from image input to results output is automatically determined to perform parallel processing.

Previous Processing Flow		42.2ms
Quad Processing Flow		18.8ms

Cut in half

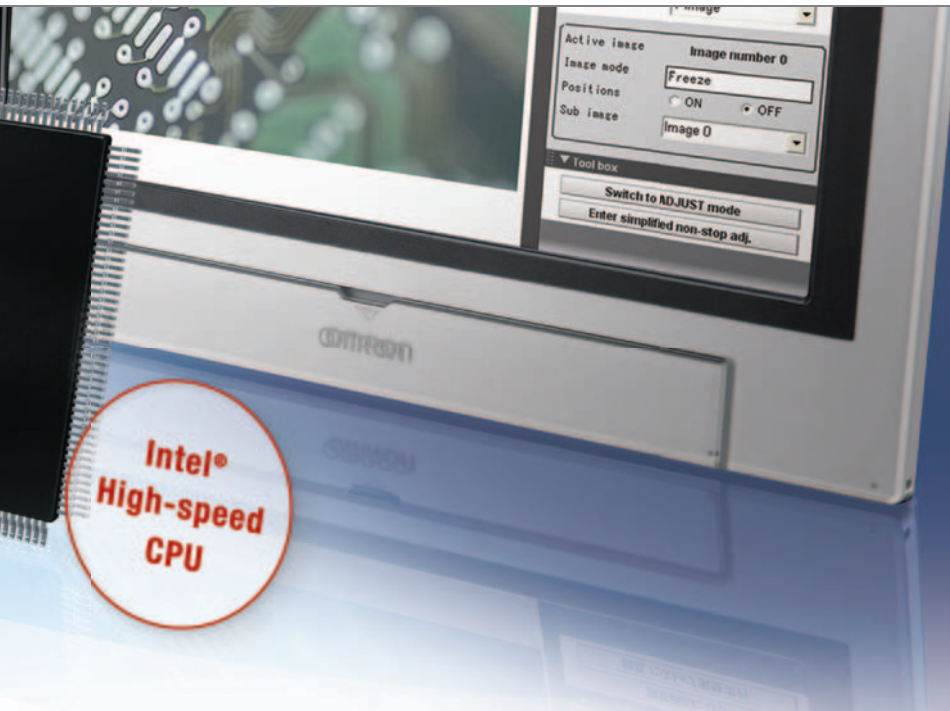

Quad processing



High-speed Processing for High-resolution Images of 5 Million Pixels

Twice the Processing Speed

Multi-core processing distributes processing to increase speed even for individual processes. The results are the most apparent for high-resolution images.

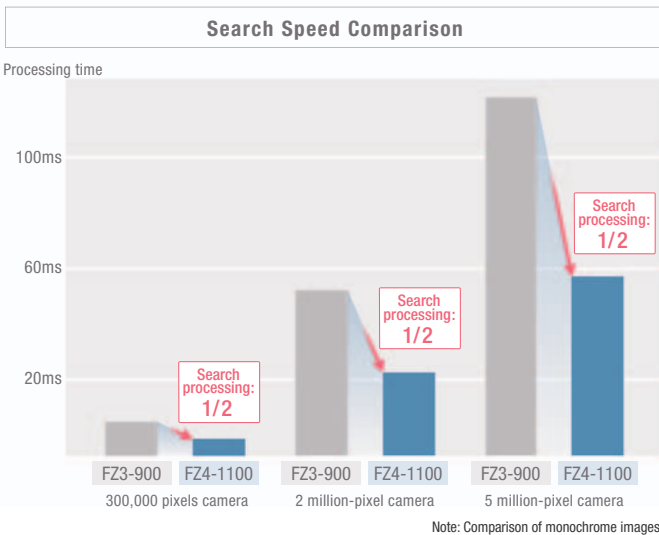

Increase Quality without Increasing Takt Time

Even if the takt time takes priority, you can still process high-resolution and Real Color images with limited affect on the takt time. We can help you increase quality for both color and resolution.

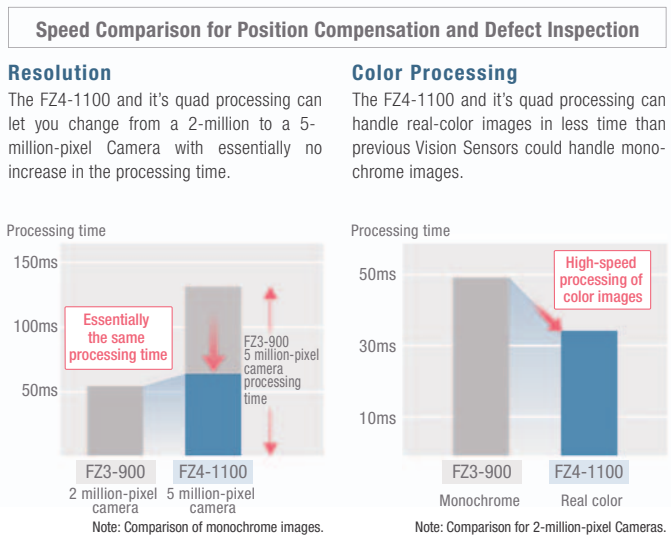

Multi-input Function Faster processing by preceding image capture and inspection in parallel Up to 32 image capture*

Each camera has its own image buffer for storing image data that is separate from the main memory used for measurement processing. This allows for up to 32 frames of continuous high-speed image capture even while the main memory is processing measurement data.

Difference from conventional method

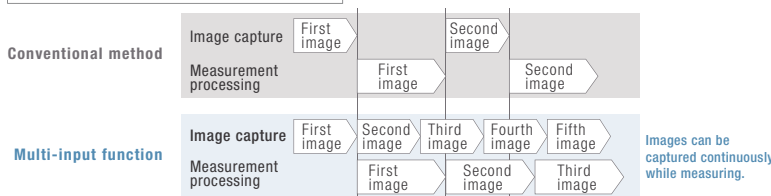

Inspection of characters printed on electronic components

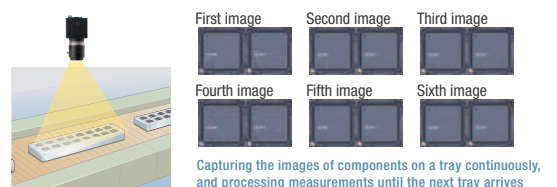

*The number of images that can be taken depends on the Controller and the Camera that is connected to it. Refer to the user's manual for details.

Greatest Detection × **Class No.1 Speed**

A Revolution in Searching Power. Shape Search II

The technology to find image patterns forms the basis of image sensing. The FZ4 features the Shape Search II, a new processing item that focuses on outline information. Even with overlapping images, tilting, or deformation, both the accuracy of recognizing image patterns and the speed of processing high-resolution images are ensured.

Maximizing Detection Performance



Deformation and Tilting



The FZ4 handles image deformation caused by the location of the workpieces when the Camera is installed at an angle, and it handles workpiece inclination.

Contrast

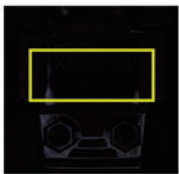

Stable detection is possible even for variations in contrast caused by lighting or workpiece orientation.

Blurring

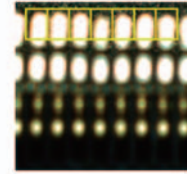
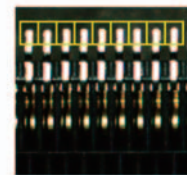

Robust processing handles image blurring caused by variations in workpiece height. Detection is possible for high-precision lenses even if a limited amount of blurring occurs.

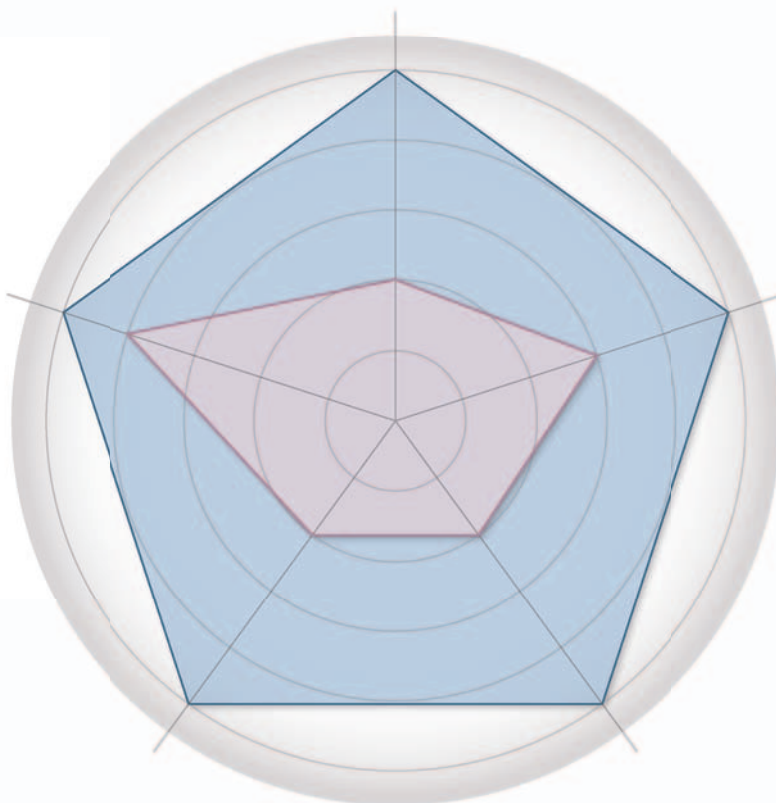

Noise

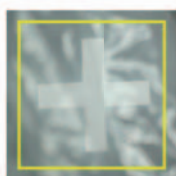

Defects



The center portion is traced even for incomplete marks that result from light reflections or noise caused by overlapping with the workpiece to simplify troublesome alignment mark detection.

Maximizing Speed

High-speed Processing at High Resolution Throughout 360° Rotation

With previous searching, the processing time was greatly increased if the workpiece was rotated or if the image resolution increased. With Shape Search II, processing time is not greatly delayed throughout 360° rotation or if resolution is increases. Manufacturing takt time can be reduced and inspection items can be added to help increase quality.

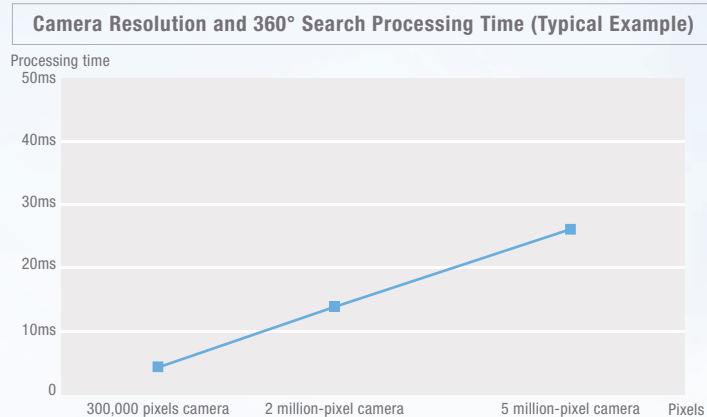

Maximizing Stability

Industry-leading positional precision

After finding the general position and orientation of the workpiece, position information on edge points enables finding the precise position and orientation. The edge point position information instead of image density information is used to detect positions more precisely than with normal searching methods.

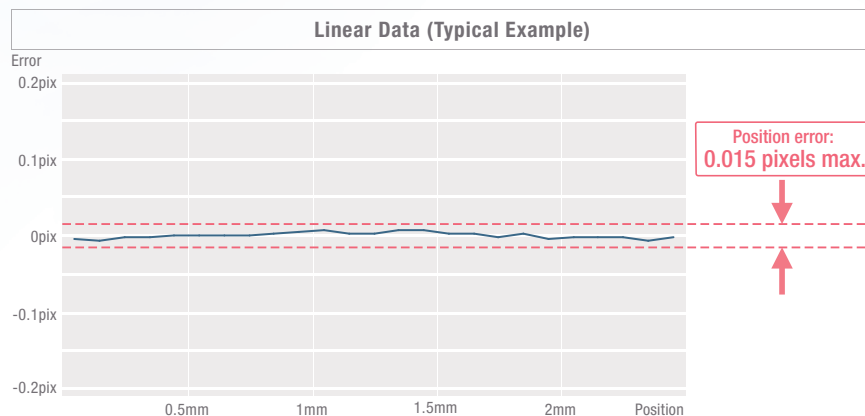

Optimizing Settings

Detection performance, speed, and stability mean that you do not need to adjust detailed parameter settings. You can quickly achieve the optimum settings and minimize setting errors caused by trying to increase performance or caused by worker differences.

Parameters can be quickly determined according to the application.

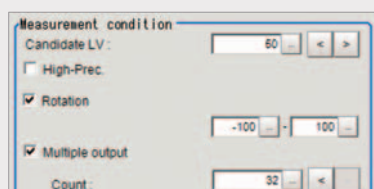

Set the parameters and register models to complete the setup.

Easily Take Advantage of a Wide Range of Functions

Program-free Design, Unique Menus for Easy Operation Onsite, and a Touch Panel.

Even long, complex processing flows can be easily set up by essentially anyone with easy operating procedures.

Program-free Flow Menus for Quick Processing Design

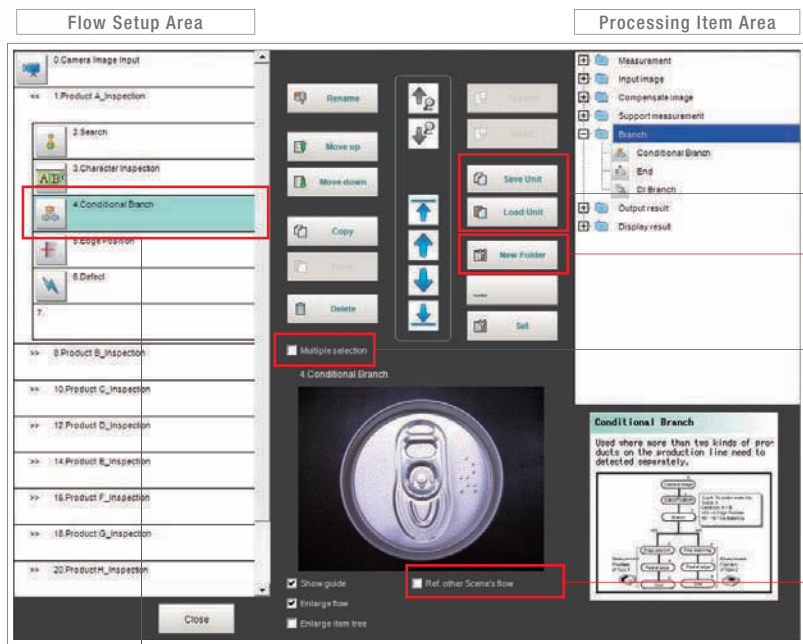

Save and Load Processing Units

You can temporarily save data when studying parameters or load data from other scene groups for an even wider range of application.

Flow Group function

Processing items can be named and grouped. You can efficiently manage a long work flow by assigning a folder to each processing item.

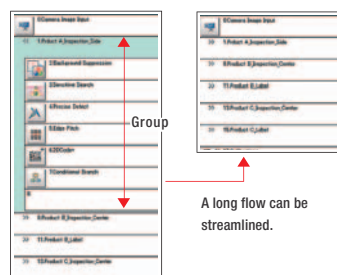

Performing different processing items at a time

You can copy or delete two or more processing items at a time by just checking them on the screen.



Conditional Branching / DI Branching

Flow menus can be changed later by branching and looping according to measurement results and input conditions. Flow menu designing at the programming level is possible through a simple process of specifying a processing item for Input Condition Branching.

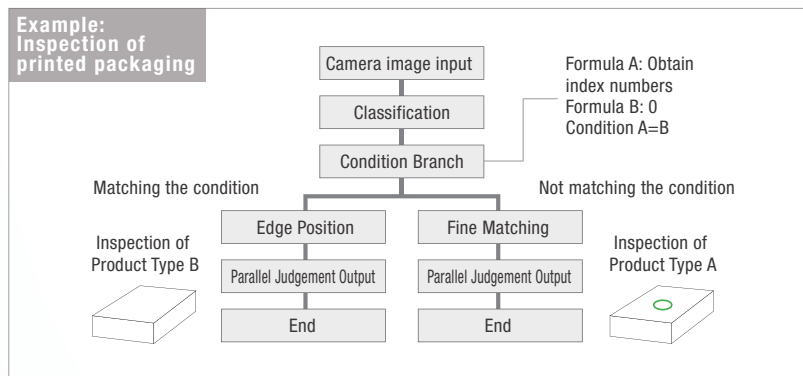

Copy & paste processing items from another scene

You can set up a new flow menu by combining different processing items copied from other scenes. When you want to utilize the setting of other scene, you do not need to make adjustments.

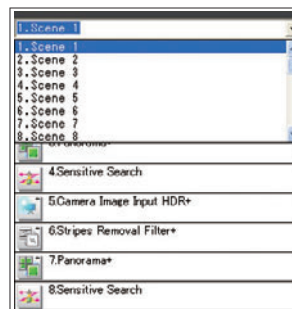

Intuitive Operation on a Touch Panel

The recent popularity of tabloid HMI is indicative of the intuitive visualization of the direct on-screen operation of functions and inspection locations that helps to increase efficiency. The touch operation of FZ menus have been praised not only in design work, but in the procedures that are required for daily operation.

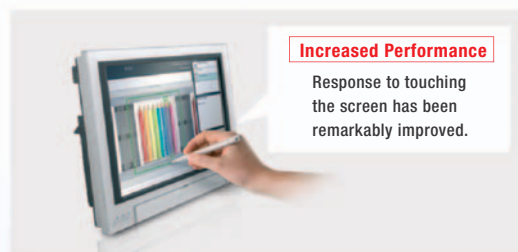

Increased Performance

Response to touching the screen has been remarkably improved.

Seamless Communications with Peripheral Devices

You can seamlessly link external devices, such as PLCs, computers, actuators, and much more. High-speed communications with a host enables a wider range of operation and management.



Easier Commissioning and Increased Range of Operation and Management

PLC Link Function

Easy Creation of Ladder Programs

A PLC Link function is included to reduce the effort in ladder programming and raise the design efficiency for serial communications and standard Ethernet.

Applicable PLCs

- OMRON CS, CJ, CP, and NSJ Series
- Mitsubishi Electric Q Series

Reading and writing I/O memory areas can be easily set on the special menu screen.

Communications Monitoring and Checking

Smooth Commissioning and Troubleshooting of Communications

Convenient monitoring functions are provided that let you see if communications is established correctly and if wiring is correct. Confirmations when commissioning the system and analysis during communications troubleshooting go smoothly.

I/O Monitor

Display of signal output status

Virtual signal inputs

Checking Serial Communications

Display of communications test results

Sending of test commands

EtherNet/IP

High-capacity, High-speed Data Communications

EtherNet/IP is a widely used communication protocol in factories around the world. You can easily connect to OMRON PLCs or any other vendor device that supports EtherNet/IP to enable high-speed communication.

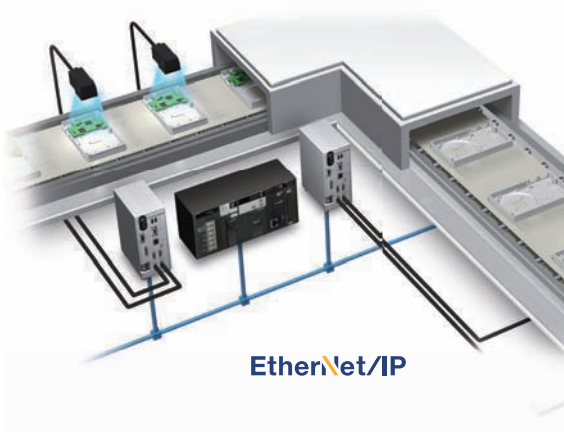

Optimum Operation both Online and Offline

Connections to a network hard disk drive or network computer enables a wide range of operation possibilities. You can log measurement images longterm, or you can perform verifications and adjustments on a computer without stopping the Vision Sensor.

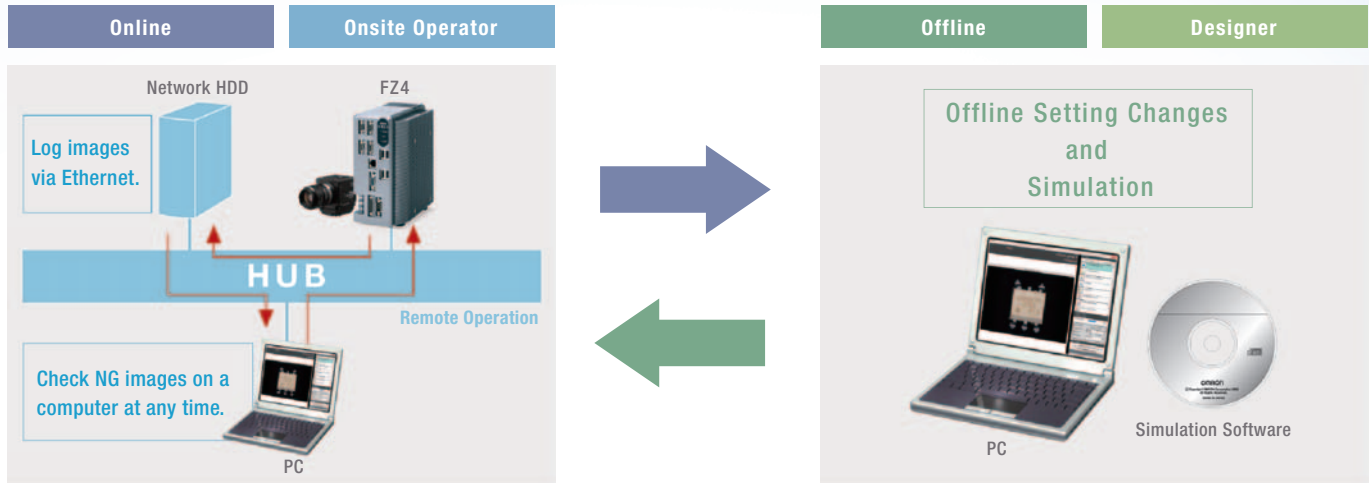

Ask your OMRON representative about obtaining simulation software.

New Operation Schemes through Network Applications

1 Daily Monitoring

You can store NG image in a network HDD to check the NG images every day on a computer without reducing inspection performance. Or you can start simulation software on your computer to remeasure and analyze NG images.

2 Periodic Adjustments and Inspection Adjustments

The non-stop adjustment function lets you change Controller settings without stopping the production line. With remote operation, you can perform operations without going onsite.

3 Handling Unstable Inspections or Measurement Failure

The user sends the designer the image data, setting data, and parameter settings. The designer can use the simulation software on the computer to check the situation and change the settings on the simulation software. The altered scene data can be returned to the user and loaded to the system to complete the adjustments. This enables smooth modifications without requiring that the designer visit the site.

4 Adding Inspections or Making Changes for New Models

Based on the images to be inspected, settings are made on the simulation software on a familiar computer. The scene data is sent to the user to easily add the new settings.

Ideal for History Management

Convert Parameter Settings to CSV Data

CSV files allow you to easily understand the parameter settings. Also, you can easily change any of the settings. If you save the standard settings, you easily find incorrect setting changes by comparing the data for differences. You can attach CSV files to email and have them uploaded to the Vision Sensor to enable easy adjustments even when troubleshooting from a remote location.

Standard settings			Current parameter settings		
#4	Defect	キズ汚れ	#4	Defect	キズ汚れ
overallJudge	総合判定反映	0	overallJudge	総合判定反映	0
upperDefect	欠陥検出サイズ上限値	6	upperDefect	欠陥検出サイズ上限値	6
lowerDefect	欠陥検出サイズ下限値	6	lowerDefect	欠陥検出サイズ下限値	6
criterionValue	欠陥度判定値	100	criterionValue	欠陥度判定値	200
#5	Search	サーチ	#5	Search	サーチ
rotation	回転有無	0	rotation	回転有無	6
endAngle	回転角度上限値	190	endAngle	回転角度上限値	190
startAngle	回転角度下限値	-190	startAngle	回転角度下限値	-190
angleSkip	読み角度	5	angleSkip	読み角度	5
smartMode	スマートモード	1	smartMode	スマートモード	1
stability	安定度(相関)	12	stability	安定度(相関)	12
accuracy	精度	2	accuracy	精度	2
searchSpeed	サーチ速度	3	searchSpeed	サーチ速度	3
referencePosX	基準座標X	320	referencePosX	基準座標X	320
referencePosY	基準座標Y	240	referencePosY	基準座標Y	240
upperCorrelation	相関値上限値	100	upperCorrelation	相関値上限値	100
lowerCorrelation	相関値下限値	60	lowerCorrelation	相関値下限値	60
saveSetting	モデル登録画像保存	0	saveSetting	モデル登録画像保存	0

Centralize Monitoring and Adjustment of Scattered Sensors

Remote Operation

You can check the status and adjust the settings of many FZ4 on one computer.

This enables efficient adjustment of Camera images when commissioning a system and application of test adjustment results.

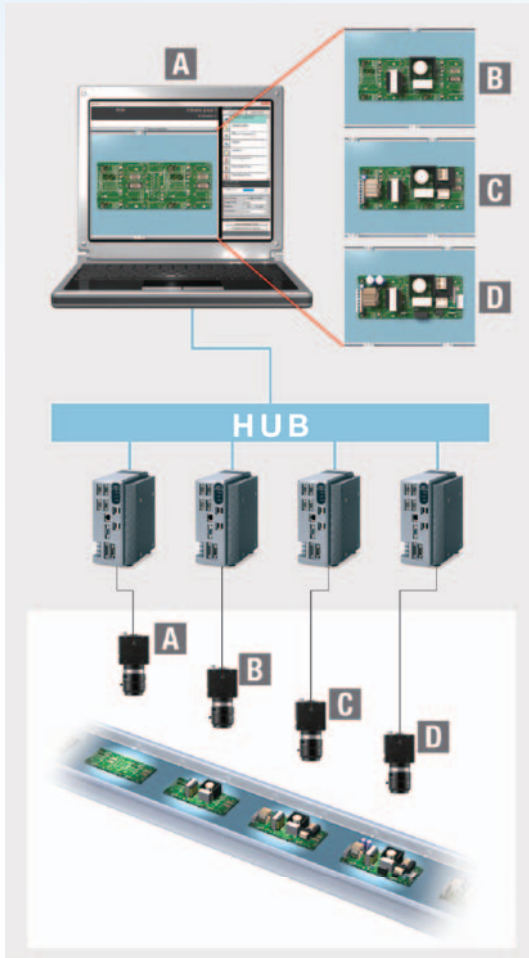

Application Example 1 | Operating Several FZ4 from One Location

- 1 When commissioning a line, from one location you can adjust the Camera images from all of the FZ4 located along the line. There's no need to go to and from remote Controllers, and you can compare Camera images under various conditions to adjust them.
- 2 If setting changes are necessary to add a new model, you can do all the required work at the same time without making trips to all of the Controllers.
- 3 You can easily balance the thresholds between Controllers when increasing inspection stability through testing at the production line.

Application Example 2 | Displaying Images from Many FZ4 on One Monitor

- 1 You can save space because you do not need to install more than one monitor.
- 2 Even if the Controllers are separated from each other, the adjustments can be made from the same location to reduce the load on workers and reduce adjustment time.

Note: Ask your OMRON representative about obtaining simulation software for a computer.

Useful Functions for Test Measurement

Continuous test measurement function

Settings must be verified with as many images as possible. With OMRON's FZ4, continuous measurements of hundreds of images can be performed by a single click.

Checking the results of continuous measurement in a graph

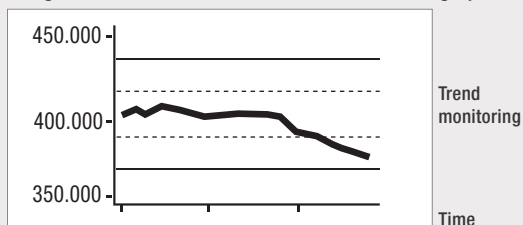

Judgment monitoring function

Continuous measurement stops automatically when a defect occurs. Once the measurement stops, you can select the next course of action right away for efficient testing and verification.

If a defect occurs, measurement stops automatically --> Select the course of action.

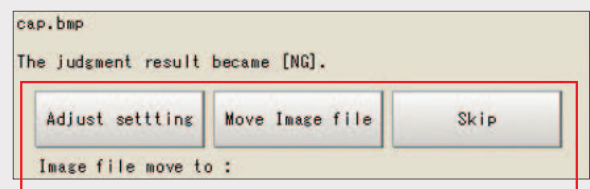

Customize Screens for Easier Operation

You can easily customize the operating screens according to the inspections or onsite conditions. This helps you prevent downtime that can result from operating mistakes or measurement failure. There are also many customization functions for troubleshooting unexpected problems.

Customization of Displays

The flexible customization of the RUN mode view is possible. Not only items to be displayed but also their layout and sizes of characters used can also be changed. This enables the creation of the most easy-to-use displays for the on-site operators.

Example of customization

- Enlarged judgement result, RUN, and processing time
- Enlarged only measurement flow

Compact Flow Displays

These convenient displays help prevent mistakes in operation and make it easy to see the results of processing.

Actual Flow of Processing Items

- 0.Camera Image Input
- 1.Folder
- 2.Flexible Search
- 3.Character Inspection
- 4.Conditional Branch
- 5.Edge Pitch
- 6.Precise Defect
- 7.
- 8.Display Last NG Image

Display on Operating Screen

Multi-screen Display, Display of the latest NG image

Displays on the Measurement screen can be changed as you like according to the number of cameras and their purposes. You can display a detail of a workpiece and its overall image at the same time on the screen. This function also enables a comparison between an NG image and the image actually being inspected.

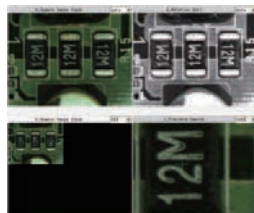

Shortcut buttons

You can arrange a set of shortcut buttons as you like. With these buttons, you can promptly cope with any problems or adjustments whenever necessary during operation.

Tool box

- Switch to ADJUST mode
- Enter simplified non-stop adj.
- Measure
- Scene switch
- Data save
- Save last logging image
- Image mode
- Zoom images

Example of customization

Change the Message Language (English, Chinese, or Japanese)

You can make the settings in English and then change the display language to Chinese or Japanese. Display the language that is best for the workers in the country of application.

English	Chinese	Japanese
0. Camera Image Input	0. 图像输入	0. カメラ画像入力
1. Search	1. 搜索	1. サーチ
2. Position Compensation	2. 位置修正	2. 位置ずれ修正
3. Labeling	3. 標籤	3. ラベリング
4. Defect	4. 缺陷	4. キズ汚れ

NEW

User Data

Ideal for Managing Inspection Standards and for Statistical Analysis of Inspection Results

New functionality has been added that enables using shared data within scene groups as constants and variables in the measurement flow. With the shared data, you can use the measurement flow in many new ways, including standard values, conditional branching flags, and counters.

Application Example 1

Unified Management of Judgment Values

When setting up complex scene data, such as the data required for inspection of many different models, you can unify management of important judgment values for inspections to easily manage and then adjust them later. Also, if you isolate in advance the settings that are critical to inspection performance (and normally known only to the designer) as user data, the locations that require adjustment can be clarified so that the user can more easily make adjustments.

Adjustment of All User Data in a List

User data list		
No.	Data	Comment
0	60.0000	Mark 1-A Search Judgement
1	60.0000	Mark 1-B Search Judgement
2	80.0000	Mark 2-A Search Judgement
3	80.0000	Mark 2-B Search Judgement
4	0.0000	NG Counter
5	0.0000	
6	0.0000	
7	0.0000	
8	0.0000	

Application Example 2

Statistical Information on Productivity Indices

User data can be used as variables that can be read and written in the inspection flow. It can also be used for counters for the number of inspected workpieces or the number of NG workpieces. Math functions can be used to calculate failure rates and display them onscreen so that productivity can be checked at any time.

Indices Displayed Onscreen with the Result Display Function

Application Method

All you have to do is set a User Data processing item in the inspection flow.

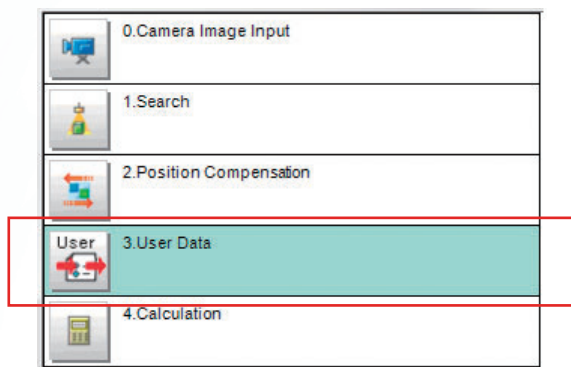

The data that is set as user data is used as shared constants and variables in different scenes.

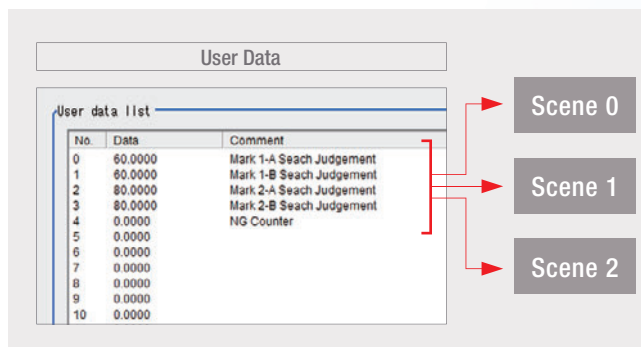

Applications of Quad Processing

Perform the Work of Two Controllers with Only One Controller

Multi-line random-trigger



With quad processors, different triggers from two lines can be input to one Controller to process two scenes in parallel and yet independently. Even if one line stops, the lines are completely independent of each other, so the other line continues to operate.

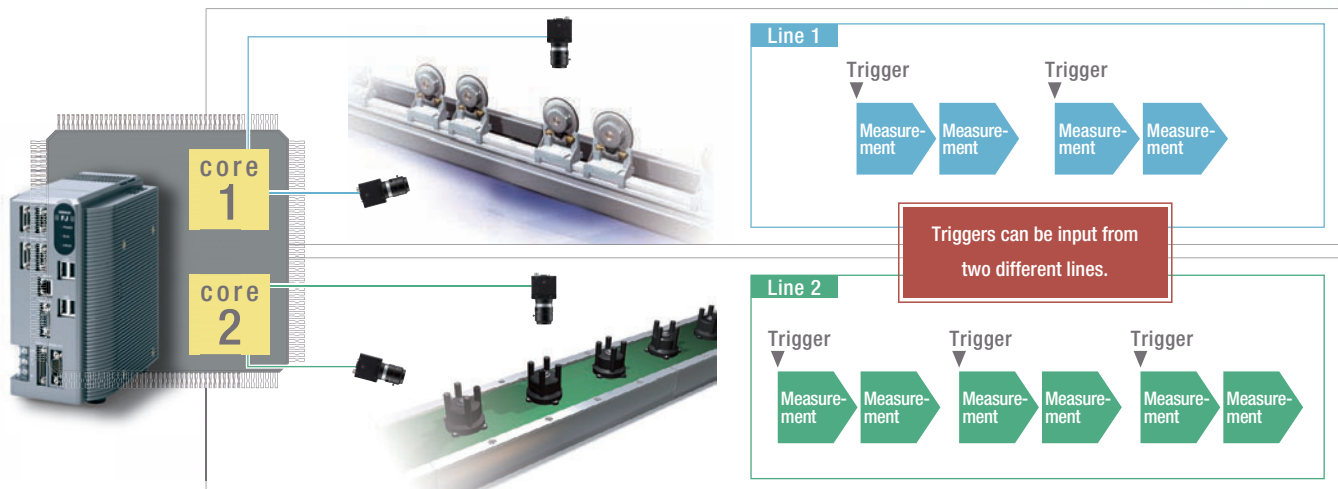

Making Confirmations and Adjustments without Stopping Production

Non-stop adjustment



Parallel processing on quad processors not only speeds up measurements, but it enables parallel processing of measurements and adjustments. Automatic distributed quad processing means that measurements are not delayed when adjustments are applied.

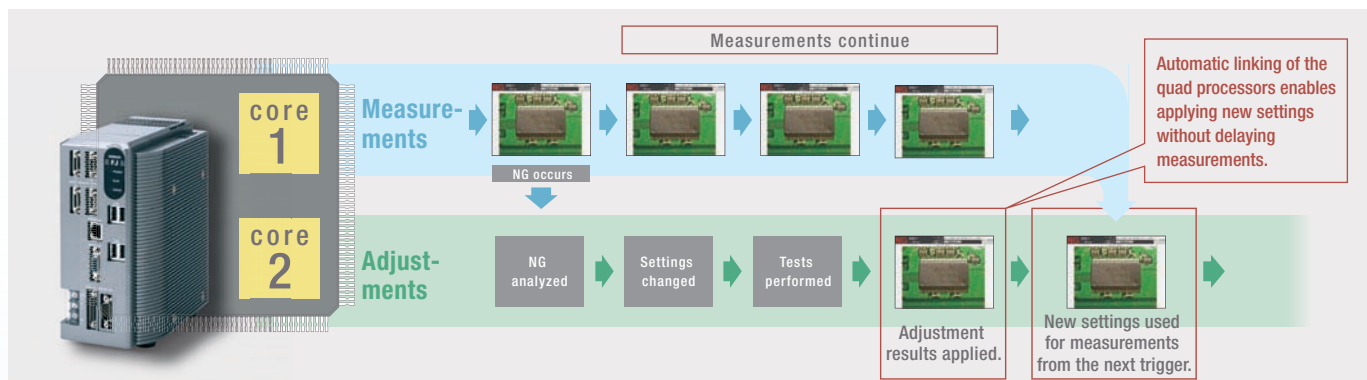

Doubly effective when combined with the Non-stop adjustment mode NG analyzer

You can display in a structured manner a graph showing the results measured at once on logging images. This lets you identify the cause of a given NG much more quickly. You can also measure all images again after changing a given setting, to check the reliability of the new setting. Adjustment and troubleshooting has never been so quick, simple and reliable.

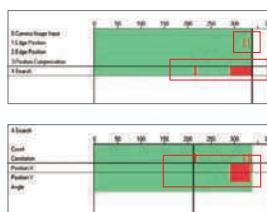

Processed items and parameters that generated an erroneous judgment can be identified at a glance.

You can check the detailed results of parameters to identify the cause of the NG.



Save All Images Even during Measurements

High speed logging



The quad processors can also perform completely parallel processing of measurements and logging, enabling high-speed connection to a high-capacity hard disk (3 terabytes). You can save all of the images for a high-speed line, something that was not previous possible.*1 And by analyzing trends for all of the saved images, you can quickly isolate the cases of NGs and formulate countermeasures.

*1 All images can be saved under the following conditions:
 • 300,000-pixel camera x 1 unit . Measurement time: 33 ms
 • Images can be saved continuously for approx. one week when a 3-terabyte HDD is used (based on 8 hours of operation a day).

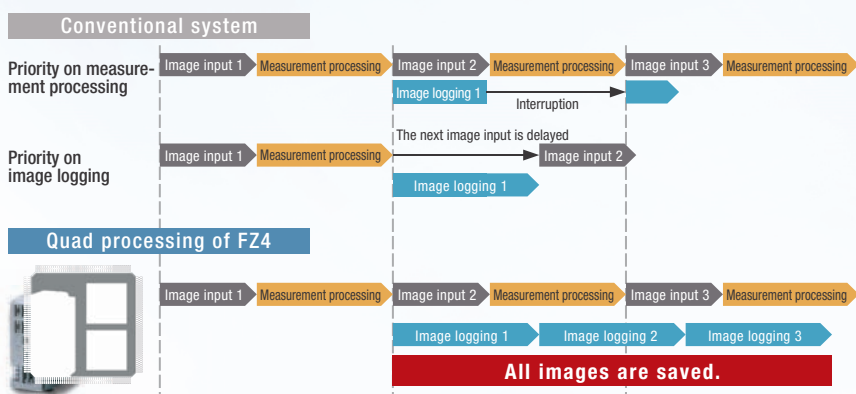

Issues

Since logging was not possible during measurement, the user had to choose either measurement or logging. Accordingly, not all images could be saved or image input triggers had to be delayed depending on the measurement trigger intervals.

Resolution

Measurement and image logging are processed completely in parallel. As a result, you can save all images.

Application Example for Saving All Images

Defect inspection on a new product or a line adopting anew manufacturing method

Printing inspection in automobile assembly processes

All images you have saved can be utilized for trend analysis to help establish an appropriate manufacturing method quickly for a new product or a line adopting a new manufacturing method.

- Effect**
- When a NG occurs, the cause can be identified and remedial actions taken quickly.
 - Saving all images leads to more efficient traceability control.

NEW More Convenience in Saving Images

It's now even more convenient to save measurement images for operational analysis, such as isolating cases of NGs and recording measurement results. You can therefore make setup work more efficient and help to increase throughput.

Save Images Directly in JPEG or BMP Format

You can easily view images on a computer or attach them to reports. With BMP files, you can measure them again on the FZ4.

Save Both Filtered and Unfiltered Images

You can save both the filtered images that were actually measured and the raw images taken directly from the Camera. You can therefore tell if an NG was caused by the input image or by the filter settings.

Restricting the Areas of Saved Images

By restricting the areas that are saved, file sizes are smaller so you can continue to log even more files.

Filtered Images **Unfiltered Images**

Optimum Performance for Almost Any Application

Digital Cameras

It does not matter if priority is on speed, resolution, or installation space, there is a Camera that is ideal for your application.

Digital Cameras											
	5 million pixels		2 million pixels		300,000 pixels		300,000 pixels High-speed		300,000 pixels small flat type		
Model	FZ-SC5M2	FZ-S5M2	FZ-SC2M	FZ-S2M	FZ-SC	FZ-S	FZ-SHC	FZ-SH	FZ-SFC	FZ-SF	
Color/Monochrome	Color	Monochrome	Color	Monochrome	Color	Monochrome	Color	Monochrome	Color	Monochrome	
Resolution	2448(H)×2044(V)		1600(H)×1200(V)		640(H)×480(V)		640(H)×480(V)		640(H)×480(V)		
Image read time	62.5ms		33.3ms		12.5ms		4.9ms		12.5ms		
Built-in lighting	—		—		—		—		—		
Lighting synchronization	—		—		—(*)		—		—		
Brightness adjustment	—		—		—		—		—		
Focusing	—		—		—		—		—		

*Synchronized control of external light is possible if a Strobe Controller is also used.

All Cameras can be connected to

Controllers

You can connect any Camera to the FZ4-series Controllers. There is no need to select a Controller specifically for the Camera. Select the Controller that has the optimum processors for the required speed.

FZ4-series						
		Quad Processing High-speed Controllers	Performance Models High-speed Controller	Standard Controller		
		Controller Integrated with LCD	Controller Integrated with LCD	Controller Integrated with LCD		
		Box-type Controller	Box-type Controller	Box-type Controller		
Model	FZ4-1100 series		FZ4-700 series		FZ4-600 series	
CPU	Dual cores × two threads Core i5 2.4 GHz		Single core Core 2 Duo 2.2 GHz		Single core Celeron 2.0 GHz	
Maximum Camera pixels	5 million pixels	Yes	Yes	Yes	Yes	Yes
	2 million pixels	Yes	Yes	Yes	Yes	Yes
	300,000 pixels	Yes	Yes	Yes	Yes	Yes
	360,000 pixels	Yes	Yes	Yes	Yes	Yes
Maximum number of Cameras	4 max		4 max *1		4 max *1	
Touch panel	Yes(Controller Integrated with LCD)		Yes(Controller Integrated with LCD)		Yes(Controller Integrated with LCD)	
Monitor output	Analog RGB/XGA		Analog RGB/XGA		Analog RGB/XGA	
High-Grade Processing Items *2	Yes(H-series only)		Yes(H-series only)		Yes(H-series only)	

*1 When connecting 5 million-pixel cameras, up to two cameras can be connected.
*2 Refer to page 35 for details on high-grade (HG) processing items.

Image Creation Technology Has Also Advanced

A library of image filters is provided to enable stable images regardless of severe onsite conditions or workpiece status.

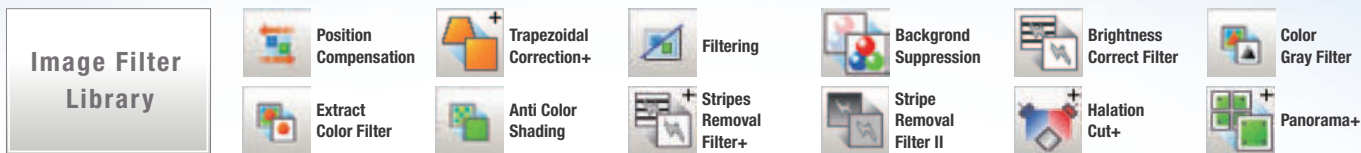

NEW **Brightness Correct Filter**

These filter cut out uneven lighting and changes in brightness caused by workpiece surface irregularities to make characteristic features stand out clearly.

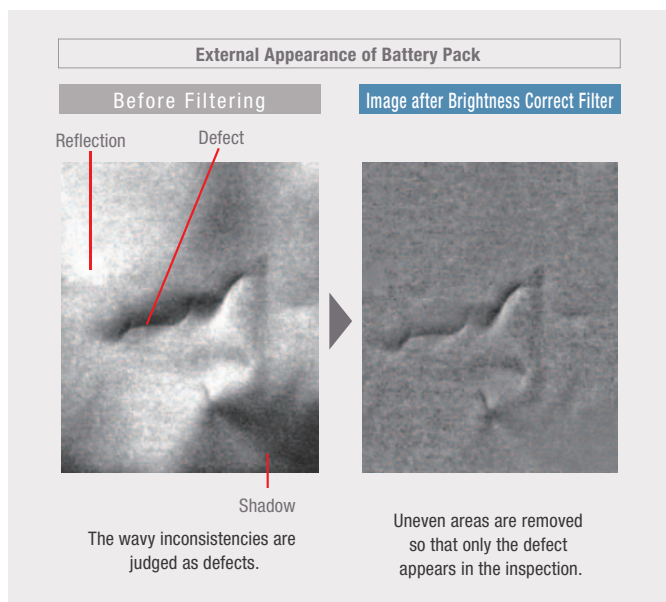

NEW **Stripe Removal Filter II**

The stripped pattern is filtered out so that only required aspects are shown clearly. Vertical, horizontal, and diagonal stripes can be removed.

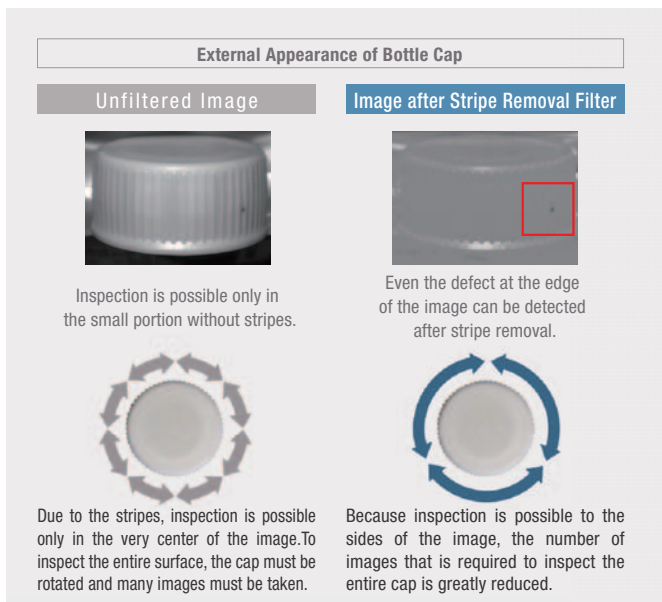

NEW **Precise Calibration**

When ultra-high-precision is required, it is necessary to align the coordinates of the Camera's field of vision with the actual coordinate system.

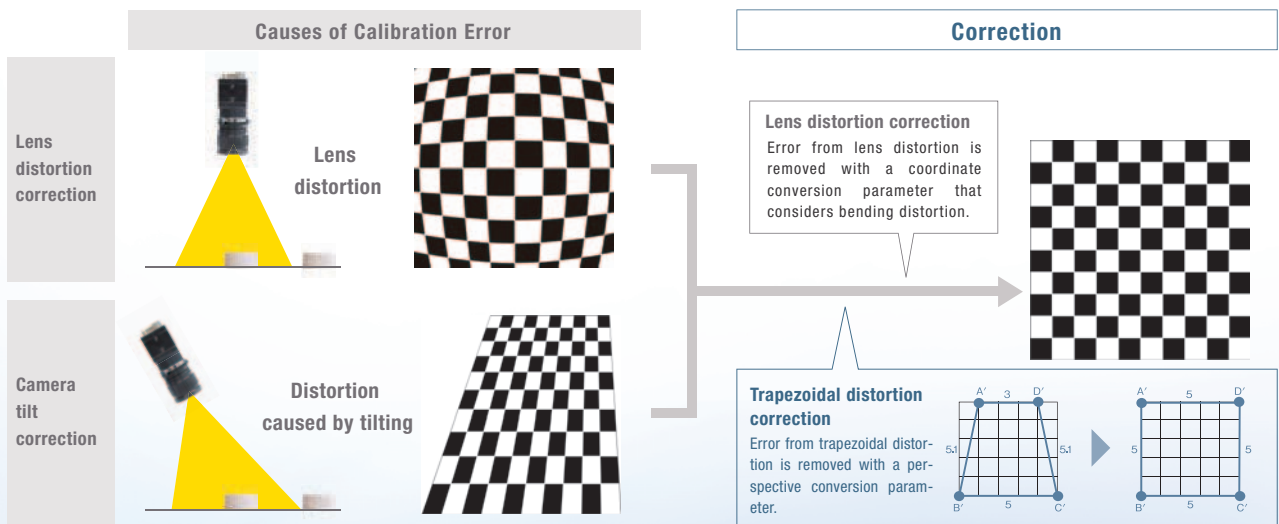

High Dynamic Range Function Patent Pending

FZ4's high dynamic range minimizes the effects of lighting such as halation and allows highly precise inspections.

Conventional images

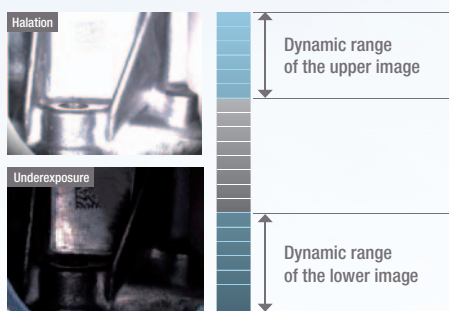

Defects Undetectable Due to Overexposure or Underexposure
Any spot outside the dynamic range is blurred by halation or shadow.

HDR image

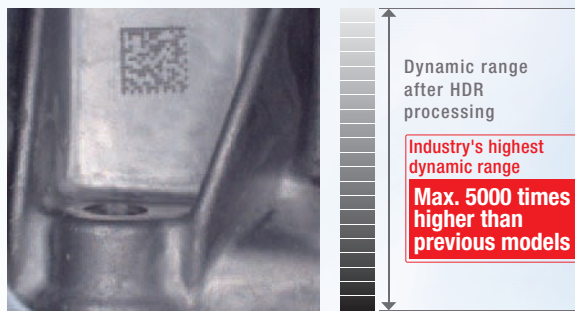

Defects Detectable Even on Reflective or Shadowy Surfaces
The surface of the workpiece is accurately reproduced and detected even with overexposure or underexposure.

Reflective and shadowy areas can be reproduced simultaneously under the same lighting conditions.

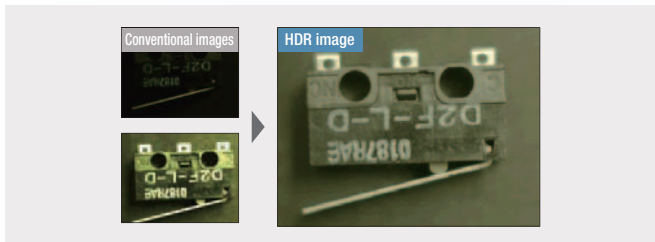

The reflective surfaces of cylindrically-curved workpieces in which conventional vision sensors have had difficulty can be reproduced.



What is Real Color Sensing? Patented

In order to secure stable measurements in different inspection environments, FZ4 Series feature Omron's proprietary Real Color Sensing processing, in addition to the conventional color image processing.

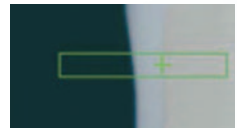

Color Segmentation Processing

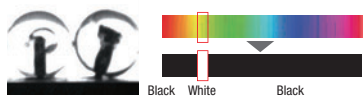

Color images taken by the camera are processed after being converted into black and white pixels. The color extracted is represented as white, and the other colors as black. Based on minimum information, high speed processing is possible. Since color data is limited only to brightness, however, it takes a long time to make optical adjustments for extracting color features.

Color Image Processing

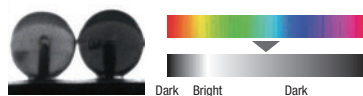

Color images are converted into 256 levels of black-and-white brightness and the contrasts of specific colors is enhanced. More precise, stable results can be produced compared to color segmentation. However, this method has difficulty in capturing subtle variations in color because all colors are converted into black-and-white brightness levels. Therefore, it is difficult to detect subtle changes in images with low contrast.

Real Color Sensing

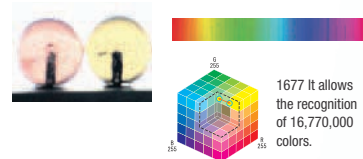

Different colors are represented as different positions in the 3D RGB space. Subtle variations in color can be recognized by representing them as distances between different color pixels comprising this space. Thus, scratches and dirt can be detected accurately even in images with low contrast.

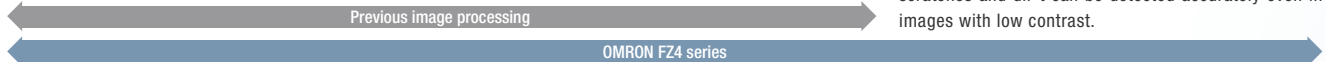

Complete Processing Library To Handle a Wide Range of

There are now even more processing items that help you quickly solve inspection and measurement problems.

Searching

You can detect minute differences without false detections.

To achieve that, we provide a complete array of search processes that meet onsite requirements.

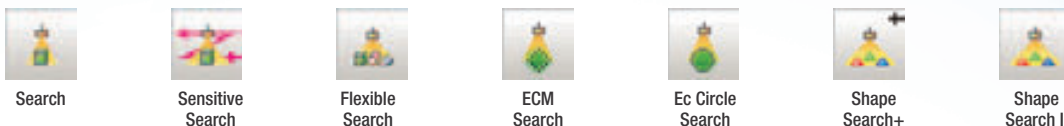

Sensitive Search

This allows the recognition of very subtle differences that cannot be detected through ordinary search processes, by dividing the registered model image into several pieces and carefully matching them. Thus you don't have to spend a lot of time for delicate threshold setting.



Flexible Search

When inspecting workpieces with some variations in shape, such variations are sometimes recognized erroneously as defects. Flexible Search ensures accurate searches regardless of some variations in print quality or shape, by registering several images of non-defective products as models. It helps you decrease your inspection failure rate by rejecting defective products only.

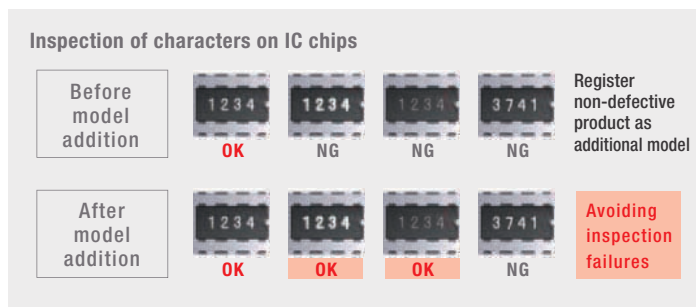

Edges

Measure positions, widths, or number of edges.

These processing items let you measure positions, widths, and the number of edges from edge information.

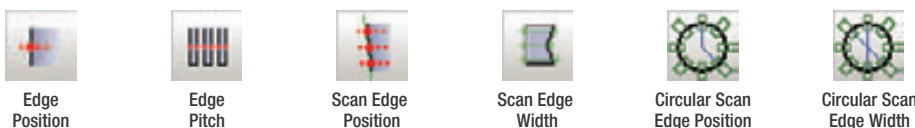

NEW **Circular Scan Edge Position**

You can measure the center coordinates, diameter, and radius of a round workpiece without performing any calculations simply by drawing one measurement region.

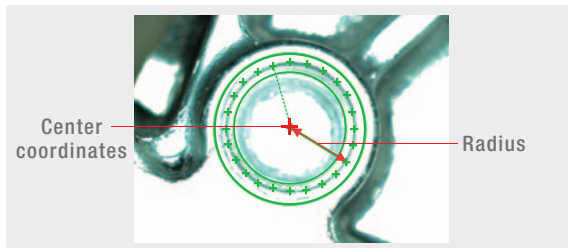

NEW **Circular Scan Edge Width**

You can measure the center coordinates, width, and thickness of a ring-shaped workpiece without performing any calculations.

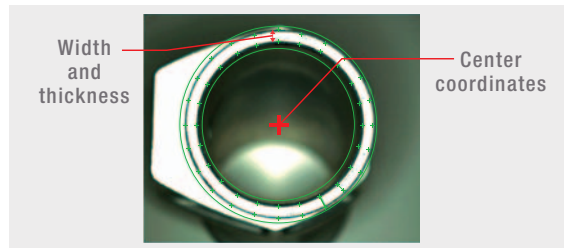

Areas

These processing items let you measure sizes, positions of centers of gravity, and the number of objects.

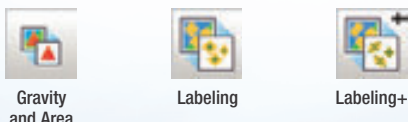

Different Types of Inspections

Defects

These processing items are ideal for external appearance inspections for damage, foreign matter, etc.



Defect



Precise Defect



Fine Matching

Inspections of Scratches and Dirt

Subtle scratches and dirt can be detected with more fine-tuned conditions compared to conventional inspections. Since you can clearly distinguish defects to be detected from the background, the failure detection rate can be decreased. Profiles of defects and comparison elements can be displayed on the screen in real time. You can adjust by confirming the settings and detection results on the image.

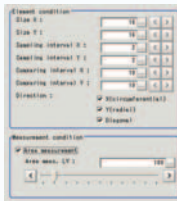

Fine parameters for defect detection allow fine settings at the pixel level. Combined with our 5 million-pixel camera, this function enables much more precise inspections of scratches.

Scratch detection profile displayed on the screen
Patent Pending

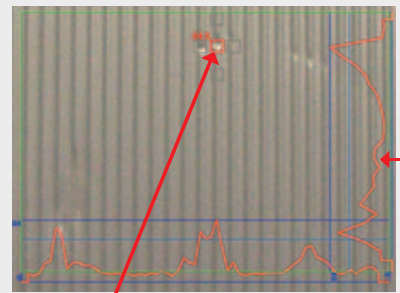

Comparison element display
Intervals and sizes of comparing elements are displayed.

Profile display
Defects of each direction for detection are displayed as wave profiles.

Fine Matching / Defect

With our Real Color Sensing technology, FZ4 can accurately recognize and process subtle variations in color. This feature helps you detect unpredictable scratches and dirt. High precision defect inspections are possible by using both Fine Matching and Defect flexibly according to the background of each image.

Fine Matching

It is useful for detecting scratches, chipped edges or subtle dirt in complex backgrounds.

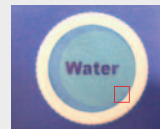

Defect

It is useful for detecting scratches and dirt in plain backgrounds.

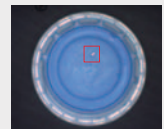

Character Inspections

These processing items provide the functions that are required for character inspections of dates, lot numbers, etc.



Character Inspection



Date Verification

Codes

These processing items can read bar codes and 2D codes from Camera images.



Barcode+



2D Code+



2D Code

NEW

2D Code

You can automatically correct for damaged codes and errors, and you can display corrected portions in red for visual emphasis. Locations that require modification are quickly understood for rapid feedback to printing devices.

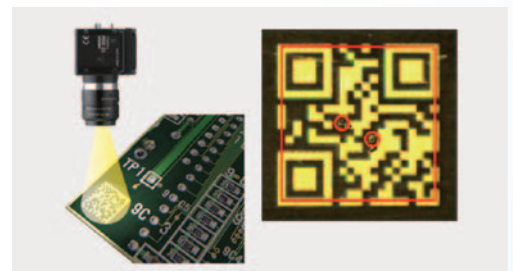

Special Processing

Frequently uses functions are also provided in these convenient processing items.



Classification





Color Data



Circle Angle

Ordering Information











Item	Descriptions	High-Grade Proc' Items	No.of cameras	Output	Model	Remarks	
FZ4 Series Controllers   	Quad Processing High-speed Controllers	○	2	NPN	FZ4-H1100 (See note 4.)	With touch pen	
				PNP	FZ4-H1105 (See note 4.)		
			4	NPN	FZ4-H1100-10 (See note 4.)		
				PNP	FZ4-H1105-10 (See note 4.)		
			2	NPN	FZ4-H1150 (See note 3.)		
				PNP	FZ4-H1155 (See note 3.)		
		4	NPN	FZ4-H1150-10 (See note 3.)			
			PNP	FZ4-H1155-10 (See note 3.)			
		-	Controllers integrated with LCD	2	NPN	FZ4-1100 (See note 2.)	With touch pen
					PNP	FZ4-1105 (See note 2.)	
				4	NPN	FZ4-1100-10 (See note 2.)	
			PNP		FZ4-1105-10 (See note 2.)		
	Box-type controllers		2	NPN	FZ4-1150 (See note 2.)		
				PNP	FZ4-1155 (See note 2.)		
		4	NPN	FZ4-1150-10 (See note 2.)			
	PNP		FZ4-1155-10 (See note 2.)				
	High-speed Controllers	○	2	NPN	FZ4-H700 (See note 1.)	With touch pen	
				PNP	FZ4-H705 (See note 1.)		
			4	NPN	FZ4-H700-10 (See note 1.)		
				PNP	FZ4-H705-10 (See note 1.)		
			2	NPN	FZ4-H750 (See note 1.)		
				PNP	FZ4-H755 (See note 1.)		
		4	NPN	FZ4-H750-10 (See note 1.)			
			PNP	FZ4-H755-10 (See note 1.)			
		-	Controllers integrated with LCD	2	NPN	FZ4-700 (See note 1.)	With touch pen
					PNP	FZ4-705 (See note 1.)	
				4	NPN	FZ4-700-10 (See note 1.)	
			PNP		FZ4-705-10 (See note 1.)		
	Box-type controllers		2	NPN	FZ4-750 (See note 1.)		
				PNP	FZ4-755 (See note 1.)		
		4	NPN	FZ4-750-10 (See note 1.)			
	PNP		FZ4-755-10 (See note 1.)				
	Standard Controllers	○	2	NPN	FZ4-H600 (See note 4.)	With touch pen	
				PNP	FZ4-H605 (See note 4.)		
			4	NPN	FZ4-H600-10 (See note 4.)		
				PNP	FZ4-H605-10 (See note 4.)		
2			NPN	FZ4-H650 (See note 3.)			
			PNP	FZ4-H655 (See note 3.)			
4		NPN	FZ4-H650-10 (See note 3.)				
		PNP	FZ4-H655-10 (See note 3.)				
-		Controllers integrated with LCD	2	NPN	FZ4-600 (See note 2.)	With touch pen	
				PNP	FZ4-605 (See note 2.)		
			4	NPN	FZ4-600-10 (See note 2.)		
		PNP		FZ4-605-10 (See note 2.)			
	Box-type controllers	2	NPN	FZ4-650 (See note 2.)			
			PNP	FZ4-655 (See note 2.)			
4		NPN	FZ4-650-10 (See note 2.)				
	PNP	FZ4-655-10 (See note 2.)					
Lite Controllers	-	2	NPN	FZ4-L350 (See note 2.)	-		
			PNP	FZ4-L355 (See note 2.)			
		4	NPN	FZ4-L350-10 (See note 2.)			
			PNP	FZ4-L355-10 (See note 2.)			

















Note 1: The production of the FZ4-series Controllers FZ4-(H)75□/(H)75□-10, FZ4-(H)70□/(H)70□-10 were discontinued at the end of March 2015.

2: The production of the FZ4-series Controllers FZ4-110□/-110□-10/-115□/-115□-10, FZ4-60□/-60□-10/-65□/-65□-10, FZ4-L35□/-L35□-10 were discontinued at the end of October 2015.

3: The production of the FZ4-series Controllers FZ4-H65□/-H65□-10, FZ4-H115□/-H115□-10 were discontinued at the end of September 2016.

4: The production of the FZ4-series Controllers FZ4-H110□/-H110□-10, FZ4-H60□/-H60□-10 will be discontinued at the end of March 2018.

Item		Descriptions		Model	Remarks		
Cameras		Digital Cameras	5 million pixels	Color	FZ-SC5M2	Lens required	
				Monochrome	FZ-S5M2		
		Digital Cameras	2 million pixels	Color	FZ-SC2M		
				Monochrome	FZ-S2M		
		Digital Cameras	300,000 pixels	Color	FZ-SC		
				Monochrome	FZ-S		
		High-speed Cameras	300,000 pixels	Color	FZ-SHC		
				Monochrome	FZ-SH		
		Small Digital Cameras	300,000-pixel flat type	Color	FZ-SFC		Lenses for small camera required
				Monochrome	FZ-SF		
		Small Digital Cameras	300,000-pixel pen type	Color	FZ-SPC		
				Monochrome	FZ-SP		
	Intelligent Compact Cameras	Narrow view	Color	FZ-SQ010F	Camera + Manual Focus Lens + High power Lighting		
		Standard view	Color	FZ-SQ050F			
		Wide View (long-distance)	Color	FZ-SQ100F			
		Wide View (short-distance)	Color	FZ-SQ100N			
Cameras Peripheral Devices		CCTV Lenses		3Z4S-LE Series	—		
		Extension Tubes					
		Low-distortion Lenses		3Z4S-LE SV-0614H/SV-0814H/SV-1214H/SV-1614H/SV-2514H/SV-3514H/SV-5014H/SV-7525H/SV-10028H	Low distortion lens for 2-million pixel cameras and 5million-pixel cameras		
		Lenses for Small Camera		FZ-LES3/LES6/LES16/LES30	Lens for 300,000-pixel small cameras		
	Extension Tubes for Small Camera		FZ-LESR	Extension Tubes for 300,000-pixel small cameras			
		For Intelligent Compact Camera	Mounting Brackets		FQ-XL/-XL2	—	
			Polarizing Filter Attachment		FQ-XF1		

Item	Descriptions		Cable length:	Model	Remarks	
Cables		Camera Cable	2 m	FZ-VS3 2M	-	
			3 m	FZ-VS3 3M		
			5 m	FZ-VS3 5M		
			10 m (See note 2.)	FZ-VS3 10M		
		Bend resistant Camera Cable	2 m	FZ-VSB3 2M		
			3 m	FZ-VSB3 3M		
			5 m	FZ-VSB3 5M		
			10 m (See note 2.)	FZ-VSB3 10M		
		Right-angle Camera Cable (See note 1.)	2 m	FZ-VSL3 2M		
			3 m	FZ-VSL3 3M		
			5 m	FZ-VSL3 5M		
			10 m (See note 2.)	FZ-VSL3 10M		
		Bend resistant Right-angle Camera Cable (See note 1.)	2 m	FZ-VSLB3 2M		
			3 m	FZ-VSLB3 3M		
5 m			FZ-VSLB3 5M			
10 m (See note 2.)			FZ-VSLB3 10M			
	Long-distance Camera Cable	15m (See note 3.)		FZ-VS4 15M		
			Long-distance Right-angle Camera Cable (See note 1.)	15m (See note 3.)		FZ-VSL4 15M
	Cable Extension Unit			—	FZ-VSJ	Up to two Extension Units and three Cables can be connected. (Maximum cable length: 45 m (See note 4.))
	Monitor Cable	2 m	FZ-VM 2M	-		
		5 m	FZ-VM 5M			
	Parallel I/O Cable	2 m	FZ-VP 2M	-		
		5 m	FZ-VP 5M			
	Parallel I/O Cable for Connector-terminal Conversion Unit	2 m	FZ-VPX 2M	Connector-Terminal Block Conversion Units can be connected (Recommended Products: OMRON XW2RJ50G-T, XW2R-E50G-T, XW2R-P50G-T).		
		5 m	FZ-VPX 5M			
Peripheral devices			LCD Monitor	—	FZ-M08	For Box-type Controllers
		USB Memory	2 GB	—	FZ-MEM2G	Capacity: 2 GB
			8 GB	—	FZ-MEM8G	Capacity: 8 GB
			VESA Attachment	—	FZ-VESA	For installing the LCD integrated-type controller
			Desktop Controller Stand	—	FZ-DS	For installing the LCD integrated-type controller
			Display/USB Switcher	—	FZ-DU	-
		Lighting Controller	For FL-Series	—	FL-TCC1	Required to control external lighting from a Controller
	—	External Lighting		—	FL Series	-
—	Mouse		—	—	Mouse Recommended Products Driverless wired mouse (A mouse that requires the mouse driver to be installed is not supported.)	

Note 1: This Cable has an L-shaped connector on the Camera end.

2: The 10-m cable cannot be used for the 5 million-pixel camera.

3: The 15-m cable cannot be used for the 5 million-pixel camera.

4: The maximum cable length depends on the Camera being connected, and the model and length of the Cable being used.

For further information, please refer to the "Cameras / Cables" table in Page 33.

System configuration

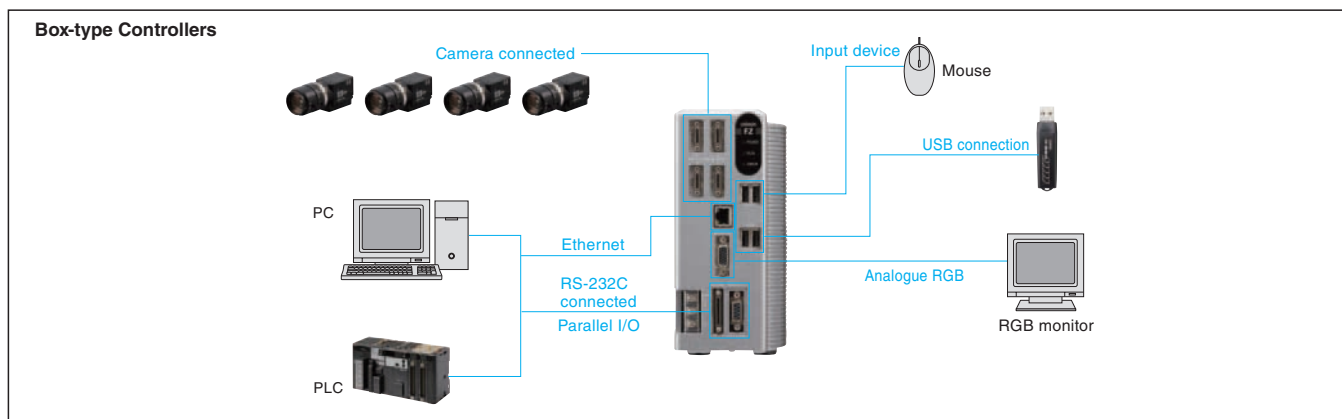
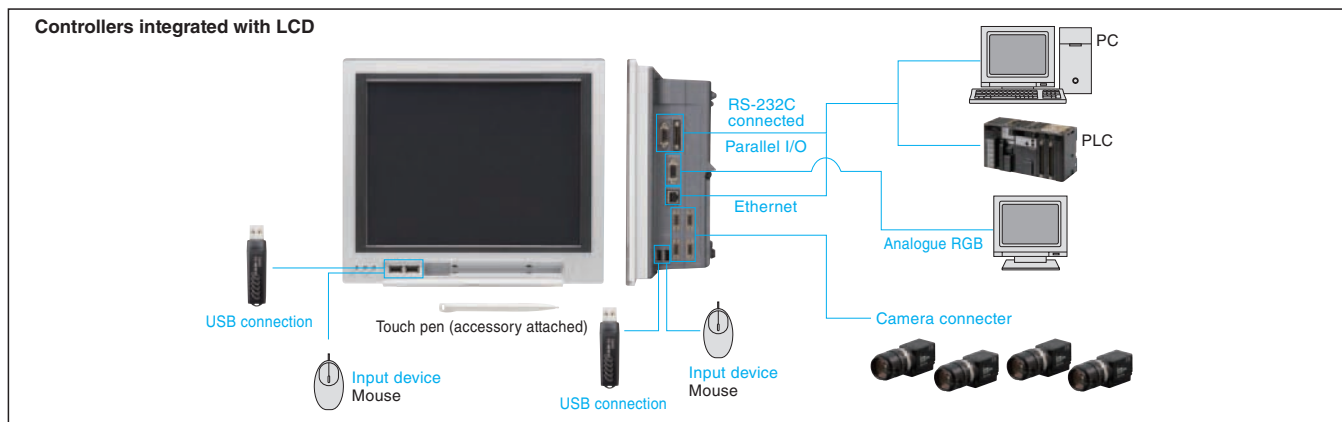

Lenses

High-resolution, Low-distortion Lenses

Model	3Z4S-LE SV-0614H	3Z4S-LE SV-0814H	3Z4S-LE SV-1214H	3Z4S-LE SV-1614H	3Z4S-LE SV-2514H	3Z4S-LE SV-3514H	3Z4S-LE SV-5014H	3Z4S-LE SV-7525H	3Z4S-LE SV-10028H
Appearance/Dimensions (mm)	42 dia. 57.5	39 dia. 52.5	30 dia. 51.0	30 dia. 47.5	30 dia. 36.0	44 dia. 45.5	44 dia. 57.5	36 dia. 42.0(WD=) to 54.6(WD:1200)	39 dia. 66.5(WD=) to 71.6(WD:2000)
Focal length	6 mm	8 mm	12 mm	16 mm	25 mm	35 mm	50 mm	75 mm	100 mm
Brightness	F1.4	F1.4	F1.4	F1.4	F1.4	F1.4	F1.4	F2.5	F2.8
Filter size	M40.5 P0.5	M35.5 P0.5	M27 P0.5	M27 P0.5	M27 P0.5	M35.5 P0.5	M40.5 P0.5	M34.0 P0.5	M37.5 P0.5

CCTV Lenses

Model	3Z4S-LE SV-03514V	3Z4S-LE SV-04514V	3Z4S-LE SV-0614V	3Z4S-LE SV-0813V	3Z4S-LE SV-1214V	3Z4S-LE SV-1614V	3Z4S-LE SV-2514V	3Z4S-LE SV-3518V
Appearance/Dimensions (mm)	29.5 dia. 30.5	29.5 dia. 29.5	30.0	28 dia. 34.0	29 dia. 29.5	29 dia. 24.0	29 dia. 24.5	29 dia. 33.9(WD=) to 37.5(WD:300)
Focal length	3.5 mm	4.5 mm	6 mm	8 mm	12 mm	16 mm	25 mm	35 mm
Brightness	F1.4	F1.4	F1.4	F1.3	F1.4	F1.4	F1.4	F1.8
Filter size	-	-	M27 P0.5	M25.5 P0.5	M27 P0.5	M27 P0.5	M27 P0.5	M27 P0.5

Model	3Z4S-LE SV-5018V	3Z4S-LE SV-7527V	3Z4S-LE SV-10035V
Appearance/Dimensions (mm)	32 dia. 37.0(WD=) to 39.4(WD:1000)	32 dia. 42.0(WD=) to 44.4(WD:1000)	32 dia. 43.9(WD=) to 46.3(WD:1000)
Focal length	50 mm	75 mm	100 mm
Brightness	F1.8	F2.7	F3.5
Filter size	M30.5 P0.5	M30.5 P0.5	M30.5 P0.5

Lenses for small camera

Model	FZ-LES3	FZ-LES6	FZ-LES16	FZ-LES30
Appearance/Dimensions (mm)	12 dia. 16.4	12 dia. 19.7	12 dia. 23.1	12 dia. 25.5
Focal length	3 mm	6 mm	16 mm	30 mm
Brightness	F2.0	F2.0	F3.4	F3.4

Extension Tubes

Model	3Z4S-LE SV-EXR
Contents	Set of 7 tubes (40 mm, 20 mm, 10 mm, 5 mm, 2.0 mm, 1.0 mm, and 0.5 mm) Maximum outer diameter: 30 mm dia.

Extension Tubes for small camera

Model	FZ-LESR
Contents	Set of 3 tubes (15 mm, 10 mm, 5 mm) Maximum outer diameter: 12 mm dia.

- Do not use the 0.5-mm, 1.0-mm, and 2.0-mm Extension Tubes attached to each other. Since these Extension Tubes are placed over the threaded section of the Lens or other Extension Tube, the connection may loosen when more than one 0.5-mm, 1.0-mm or 2.0-mm Extension Tube are used together.
- Reinforcement is required to protect against vibration when Extension Tubes exceeding 30 mm are used.

Ratings and Specifications (Controllers)

FZ4 series Quad Processing High-speed Controllers

Model		NPN Output	FZ4-1100	FZ4-1100-10	FZ4-1150	FZ4-1150-10	FZ4-H1100	FZ4-H1100-10	FZ4-H1150	FZ4-H1150-10	
		PNP Output	FZ4-1105	FZ4-1105-10	FZ4-1155	FZ4-1155-10	FZ4-H1105	FZ4-H1105-10	FZ4-H1155	FZ4-H1155-10	
Controller type		Controllers integrated with LCD			Box-type controllers		Controllers integrated with LCD		Box-type controllers		
High-grade Processing items		No						Yes			
No. of Cameras		2	4	2	4	2	4	2	4		
Connected Camera		Can be connected to all cameras.									
Processing resolution	When connected to an intelligent compact camera	752(H)×480(V)									
	When connected to a 300,000-pixel camera	640(H)×480(V)									
	When connected to a 2 million-pixel camera	1600(H)×1200(V)									
	When connected to a 5 million-pixel camera	2448(H)×2044(V)									
No. of scenes		32									
Number of logged images (See note 1.)	When connected to an intelligent compact camera	Connected to 1 camera	232								
		Connected to 2 cameras	116								
		Connected to 3 cameras	77								
		Connected to 4 cameras	58								
	When connected to a 300,000-pixel camera	Connected to 1 camera	Color camera: 270, Monochrome Camera: 272								
		Connected to 2 cameras	Color camera: 135, Monochrome Camera: 136								
		Connected to 3 cameras	Color camera: 90, Monochrome Camera: 90								
		Connected to 4 cameras	Color camera: 67, Monochrome Camera: 68								
	When connected to a 2 million-pixel camera	Connected to 1 camera	Color camera: 43, Monochrome Camera: 43								
		Connected to 2 cameras	Color camera: 21, Monochrome Camera: 21								
		Connected to 3 cameras	Color camera: 14, Monochrome Camera: 14								
		Connected to 4 cameras	Color camera: 10, Monochrome Camera: 10								
	When connected to a 5 million-pixel camera	Connected to 1 camera	Color camera: 16, Monochrome Camera: 16								
		Connected to 2 cameras	Color camera: 8, Monochrome Camera: 8								
		Connected to 3 cameras	Color camera: 5, Monochrome Camera: 5								
		Connected to 4 cameras	Color camera: 4, Monochrome Camera: 4								
Operation		Controllers integrated with LCD: Touch pen, mouse, etc. Box-type controllers: Mouse or similar device									
Settings		Create series of processing steps by editing the flowchart (Help messages provided).									
Serial communications		RS-232C/422A: 1 CH									
Network communications		Ethernet 100BASE-TX/10BASE-T									
EtherNet/IP communications		Ethernet port baud rate: 100 Mbps (100Base-TX)									
Parallel I/O		(When used in Multi-line random-trigger mode) 17 inputs (RESET, STEP0/ENCTRIG_Z0, STEP1/ENCTRIG_Z1, DSA0 to 1, ENCTRIG_A0 to 1, ENCTRIG_B0 to 1, DI0 to 7), 29 outputs (RUN/BUSY1, BUSY0, GATE0 to 1, OR0 to 1, READY0 to 1, ERROR, STGOUT0 to 3, DO0 to 15) (When used in other mode) 13 inputs (RESET, STEP0/ENCTRIG_Z0, DSA0, ENCTRIG_A0, ENCTRIG_B0, DI0 to 7), 26 outputs (RUN, BUSY0, GATE0, OR0, READY0, ERROR, STGOUT0 to 3, DO0 to 15) *STGOUT 2 to 3 only for camera 4 ch type									
Monitor interface		Controllers integrated with LCD: Integrated Controller and LCD 12.1 inch TFT color LCD (Resolution: XGA 1,024 × 768 dots) Box-type controllers: Analog RGB video output, 1 channel (Resolution: XGA 1,024 × 768 dots)									
USB interface		4 channels (supports USB 1.1 and 2.0)									
Power supply voltage		20.4 to 26.4 VDC									
Current consumption (at 24.0 VDC) (See note 2.)	When connected to an intelligent compact camera	5.0 A max.	7.5 A max.	5.0 A max.	7.5 A max.	5.0 A max.	7.5 A max.	5.0 A max.	7.5 A max.		
	When connected to a 300,000-pixel camera										
	When connected to a 2 million-pixel camera	3.7 A max.	4.9 A max.	3.7 A max.	4.9 A max.	3.7 A max.	4.9 A max.	3.7 A max.	4.9 A max.		
	When connected to a 5 million-pixel camera										
Ambient temperature range		Operating: 0 to 45°C for low cooling fan speeds, 0 to 50°C for high cooling fan speeds Storage: -20 to 65°C (with no icing or condensation)									
Ambient humidity range		Operating and storage: 35% to 85% (with no condensation)									
Weight		Approx. 3.2 kg	Approx. 3.4 kg	Approx. 1.8 kg	Approx. 1.9 kg	Approx. 3.2 kg	Approx. 3.4 kg	Approx. 1.8 kg	Approx. 1.9 kg		
Accessories		Controllers integrated with LCD: Touch pen (one, inside the front panel), Instruction Manual, 6 mounting brackets Box-type controllers: Instruction Manual									

Note 1: The image logging capacity changes when multiple cameras of different types are connected at the same time.

Note 2: The current consumption when the maximum number of cameras supported by each controller are connected.

If a strobe controller model is connected to a lamp, the current consumption is as high as when an intelligent compact camera is connected.

FZ4 series High-speed Controllers

Model		NPN Output	FZ4-700	FZ4-700-10	FZ4-750	FZ4-750-10	FZ4-H700	FZ4-H700-10	FZ4-H750	FZ4-H750-10	
		PNP Output	FZ4-705	FZ4-705-10	FZ4-755	FZ4-755-10	FZ4-H705	FZ4-H705-10	FZ4-H755	FZ4-H755-10	
Controller type		Controllers integrated with LCD			Box-type controllers		Controllers integrated with LCD		Box-type controllers		
High-grade Processing items		No					Yes				
No. of Cameras		2	4	2	4	2	4	2	4		
Connected Camera		Can be connected to all cameras. (When connecting 5 million-pixel cameras, up to two cameras can be connected.)									
Processing resolution	When connected to an intelligent compact camera	752(H)×480(V)									
	When connected to a 300,000-pixel camera	640(H)×480(V)									
	When connected to a 2 million-pixel camera	1600(H)×1200(V)									
	When connected to a 5 million-pixel camera	2448(H)×2044(V)									
No. of scenes		32									
Number of logged images (See note 1.)	When connected to an intelligent compact camera	Connected to 1 camera	214								
		Connected to 2 cameras	107								
		Connected to 3 cameras	71								
		Connected to 4 cameras	53								
	When connected to a 300,000-pixel camera	Connected to 1 camera	Color camera: 250, Monochrome Camera: 252								
		Connected to 2 cameras	Color camera: 125, Monochrome Camera: 126								
		Connected to 3 cameras	Color camera: 83, Monochrome Camera: 84								
		Connected to 4 cameras	Color camera: 62, Monochrome Camera: 63								
	When connected to a 2 million-pixel camera	Connected to 1 camera	Color camera: 40, Monochrome Camera: 40								
		Connected to 2 cameras	Color camera: 20, Monochrome Camera: 20								
		Connected to 3 cameras	Color camera: 13, Monochrome Camera: 13								
		Connected to 4 cameras	Color camera: 10, Monochrome Camera: 10								
	When connected to a 5 million-pixel camera	Connected to 1 camera	Color camera: 11, Monochrome Camera: 11								
		Connected to 2 cameras	Color camera: 5, Monochrome Camera: 5								
		Connected to 3 cameras	-								
		Connected to 4 cameras	-								
Operation		Controllers integrated with LCD: Touch pen, mouse, etc. Box-type controllers: Mouse or similar device									
Settings		Create series of processing steps by editing the flowchart (Help messages provided).									
Serial communications		RS-232C/422A: 1 CH									
Network communications		Ethernet 100BASE-TX/10BASE-T									
EtherNet/IP communications		Ethernet port baud rate: 100 Mbps (100Base-TX)									
Parallel I/O		13 inputs (RESET, STEP0/ENCTRIG_Z0, DSA0, ENCTRIG_A0, ENCTRIG_B0, DI0 to 7), 26 outputs (RUN, BUSY0, GATE0, OR0, READY0, ERROR, STGOUT0 to 3, DO0 to 15) *STGOUT 2 to 3 only for camera 4 ch type									
Monitor interface		Controllers integrated with LCD: Integrated Controller and LCD 12.1 inch TFT color LCD (Resolution: XGA 1,024 × 768 dots) Box-type controllers: Analog RGB video output, 1 channel (Resolution: XGA 1,024 × 768 dots)									
USB interface		4 channels (supports USB 1.1 and 2.0)									
Power supply voltage		20.4 to 26.4 VDC									
Current consumption (at 24.0 VDC) (See note 2.)	When connected to an intelligent compact camera	5.0 A max.	7.5 A max.	5.0 A max.	7.5 A max.	5.0 A max.	7.5 A max.	5.0 A max.	7.5 A max.		
	When connected to an intelligent camera										
	When connected to a 300,000-pixel camera										
	When connected to a 2 million-pixel camera	3.7 A max.	4.9 A max.	3.7 A max.	4.9 A max.	3.7 A max.	4.9 A max.	3.7 A max.	4.9 A max.		
Ambient temperature range		Operating: 0 to 45°C for low cooling fan speeds, 0 to 50°C for high cooling fan speeds Storage: -20 to 65°C (with no icing or condensation)									
Ambient humidity range		Operating and storage: 35% to 85% (with no condensation)									
Weight		Approx. 3.2 kg	Approx. 3.4 kg	Approx. 1.8 kg	Approx. 1.9 kg	Approx. 3.2 kg	Approx. 3.4 kg	Approx. 1.8 kg	Approx. 1.9 kg		
Accessories		Controllers integrated with LCD: Touch pen (one, inside the front panel), Instruction Manual, 6 mounting brackets Box-type controllers: Instruction Manual									

Note 1: The image logging capacity changes when multiple cameras of different types are connected at the same time.

2: The current consumption when the maximum number of cameras supported by each controller are connected.

If a strobe controller model is connected to a lamp, the current consumption is as high as when an intelligent camera is connected.

FZ4 series Standard Controllers

Model		NPN Output	FZ4-600	FZ4-600-10	FZ4-650	FZ4-650-10	FZ4-H600	FZ4-H600-10	FZ4-H650	FZ4-H650-10	
		PNP Output	FZ4-605	FZ4-605-10	FZ4-655	FZ4-655-10	FZ4-H605	FZ4-H605-10	FZ4-H655	FZ4-H655-10	
Controller type		Controllers integrated with LCD			Box-type controllers		Controllers integrated with LCD		Box-type controllers		
High-grade Processing items		No					Yes				
No. of Cameras		2	4	2	4	2	4	2	4		
Connected Camera		Can be connected to all cameras. (When connecting 5 million-pixel cameras, up to two cameras can be connected.)									
Processing resolution	When connected to an intelligent compact camera	752(H)×480(V)									
	When connected to a 300,000-pixel camera	640(H)×480(V)									
	When connected to a 2 million-pixel camera	1600(H)×1200(V)									
	When connected to a 5 million-pixel camera	2448(H)×2044(V)									
No. of scenes		32									
Number of logged images (See note 1.)	When connected to an intelligent compact camera	Connected to 1 camera	214								
		Connected to 2 cameras	107								
		Connected to 3 cameras	71								
		Connected to 4 cameras	53								
	When connected to a 300,000-pixel camera	Connected to 1 camera	Color camera: 250, Monochrome Camera: 252								
		Connected to 2 cameras	Color camera: 125, Monochrome Camera: 126								
		Connected to 3 cameras	Color camera: 83, Monochrome Camera: 84								
		Connected to 4 cameras	Color camera: 62, Monochrome Camera: 63								
	When connected to a 2 million-pixel camera	Connected to 1 camera	Color camera: 40, Monochrome Camera: 40								
		Connected to 2 cameras	Color camera: 20, Monochrome Camera: 20								
		Connected to 3 cameras	Color camera: 13, Monochrome Camera: 13								
		Connected to 4 cameras	Color camera: 10, Monochrome Camera: 10								
	When connected to a 5 million-pixel camera	Connected to 1 camera	Color camera: 11, Monochrome Camera: 11								
		Connected to 2 cameras	Color camera: 5, Monochrome Camera: 5								
		Connected to 3 cameras	—								
		Connected to 4 cameras	—								
Operation		Controllers integrated with LCD: Touch pen, mouse, etc. Box-type controllers: Mouse or similar device									
Settings		Create series of processing steps by editing the flowchart (Help messages provided).									
Serial communications		RS-232C/422A: 1 CH									
Network communications		Ethernet 100BASE-TX/10BASE-T									
EtherNet/IP communications		Ethernet port baud rate: 100 Mbps (100Base-TX)									
Parallel I/O		13 inputs (RESET, STEP0/ENCTRIG_Z0, DSA0, ENCTRIG_A0, ENCTRIG_B0, DI0 to 7), 26 outputs (RUN, BUSY0, GATE0, OR0, READY0, ERROR, STGOUT0 to 3, DO0 to 15) *STGOUT 2 to 3 only for camera 4 ch type									
Monitor interface		Controllers integrated with LCD: Integrated Controller and LCD 12.1 inch TFT color LCD (Resolution: XGA 1,024 × 768 dots) Box-type controllers: Analog RGB video output, 1 channel (Resolution: XGA 1,024 × 768 dots)									
USB interface		4 channels (supports USB 1.1 and 2.0)									
Power supply voltage		20.4 to 26.4 VDC									
Current consumption (at 24.0 VDC) (See note 2.)	When connected to an intelligent compact camera	5.0 A max.	7.5 A max.	5.0 A max.	7.5 A max.	5.0 A max.	7.5 A max.	5.0 A max.	7.5 A max.		
	When connected to a 300,000-pixel camera										
	When connected to a 2 million-pixel camera	3.7 A max.	4.9 A max.	3.7 A max.	4.9 A max.	3.7 A max.	4.9 A max.	3.7 A max.	4.9 A max.		
	When connected to a 5 million-pixel camera										
Ambient temperature range		Operating: 0 to 45°C for low cooling fan speeds, 0 to 50°C for high cooling fan speeds Storage: -20 to 65°C (with no icing or condensation)									
Ambient humidity range		Operating and storage: 35% to 85% (with no condensation)									
Weight		Approx. 3.2 kg	Approx. 3.4 kg	Approx. 1.8 kg	Approx. 1.9 kg	Approx. 3.2 kg	Approx. 3.4 kg	Approx. 1.8 kg	Approx. 1.9 kg		
Accessories		Controllers integrated with LCD: Touch pen (one, inside the front panel), Instruction Manual, 6 mounting brackets Box-type controllers: Instruction Manual									

Note 1: The image logging capacity changes when multiple cameras of different types are connected at the same time.

Note 2: The current consumption when the maximum number of cameras supported by each controller are connected.

If a strobe controller model is connected to a lamp, the current consumption is as high as when an intelligent compact camera is connected.

FZ4 series Lite Controllers

Model		NPN Output	FZ4-L350	FZ4-L350-10
		PNP Output	FZ4-L355	FZ4-L355-10
Controller type		Box-type controllers		
High-grade Processing items		No		
No. of Cameras		2	4	
Connected Camera		Can be connected to all cameras. (When connecting 5 million-pixel cameras, up to two cameras can be connected.)		
Processing resolution	When connected to an intelligent compact camera	752(H)×480(V)		
	When connected to a 300,000-pixel camera	640(H)×480(V)		
	When connected to a 2 million-pixel camera	1600(H)×1200(V)		
	When connected to a 5 million-pixel camera	2448(H)×2044(V)		
No. of scenes		32		
Number of logged images (See note 1.)	When connected to an intelligent compact camera	Connected to 1 camera	214	
		Connected to 2 cameras	107	
		Connected to 3 cameras	71	
		Connected to 4 cameras	53	
	When connected to a 300,000-pixel camera	Connected to 1 camera	Color camera: 250, Monochrome Camera: 252	
		Connected to 2 cameras	Color camera: 125, Monochrome Camera: 126	
		Connected to 3 cameras	Color camera: 83, Monochrome Camera: 84	
		Connected to 4 cameras	Color camera: 62, Monochrome Camera: 63	
	When connected to a 2 million-pixel camera	Connected to 1 camera	Color camera: 40, Monochrome Camera: 40	
		Connected to 2 cameras	Color camera: 20, Monochrome Camera: 20	
		Connected to 3 cameras	Color camera: 13, Monochrome Camera: 13	
		Connected to 4 cameras	Color camera: 10, Monochrome Camera: 10	
	When connected to a 5 million-pixel camera	Connected to 1 camera	Color camera: 11, Monochrome Camera: 11	
		Connected to 2 cameras	Color camera: 5, Monochrome Camera: 5	
		Connected to 3 cameras	-	
		Connected to 4 cameras	-	
Operation		Mouse or similar device		
Settings		Create series of processing steps by editing the flowchart (Help messages provided).		
Serial communications		RS-232C: 1 CH		
Network communications		Ethernet 1000BASE-T/100BASE-TX/10BASE-T		
EtherNet/IP communications		Ethernet port baud rate: 100 Mbps (100Base-TX)		
Parallel I/O		11 inputs (RESET, STEP, DSA, and DI 0 to 7), 26 outputs (RUN, BUSY, GATE, OR, READY, ERROR, STGOUT 0 to 3, and DO 0 to 15) *STGOUT 2 to 3 only for camera 4 ch type		
Monitor interface		Analog RGB video output, 1 channel (Resolution: XGA 1,024 × 768 dots)		
USB interface		2 channels (supports USB 1.1 and 2.0)		
Power supply voltage (See note 2.)		20.4 to 26.4 VDC		
Current consumption (at 24.0 VDC) (See note 3.)	When connected to an intelligent compact camera	4.0 A max.	5.5 A max.	
	When connected to a 300,000-pixel camera	2.6 A max.	2.9 A max.	
	When connected to a 2 million-pixel camera			
	When connected to a 5 million-pixel camera			
Ambient temperature range		Operating: 0 to 45°C, 0 to 50°C Storage: -20 to 65°C (with no icing or condensation)		
Ambient humidity range		Operating and storage: 35% to 85% (with no condensation)		
Weight		Approx. 1.8 kg		
Accessories		Instruction Manual		

Note 1: The image logging capacity changes when multiple cameras of different types are connected at the same time.

2: Do not ground the positive terminal of the 24-VDC power supply to a Lite Controller.

If the positive terminal is grounded, electrical shock may occur when an SG (0-V) part, such as the case of the Controller or Camera, is touched.

3: The current consumption when the maximum number of cameras supported by each controller are connected.

If a strobe controller model is connected to a lamp, the current consumption is as high as when an intelligent compact camera is connected.

Ratings and Specifications (Cameras)

Digital Cameras

	FZ-S	FZ-SC	FZ-S2M	FZ-SC2M	FZ-S5M2	FZ-SC5M2
Image elements	Interline transfer reading all pixels, 1/3-inch CCD image elements		Interline transfer reading all pixels, 1/1.8-inch CCD image elements		Interline transfer reading all pixels, 2/3-inch CCD image elements	
Color/Monochrome	Monochrome	Color	Monochrome	Color	Monochrome	Color
Effective pixels	640(H)×480(V)		1600(H)×1200(V)		2448(H)×2044(V)	
Pixel size	7.4(μm)×7.4(μm)		4.4(μm)×4.4(μm)		3.45(μm)×3.45(μm)	
Shutter function	Electronic shutter; select shutter speeds from 1/10 to 1/50,000 s					
Partial function	12 to 480 lines		12 to 1200 lines		12 to 2044 lines	
Frame rate (image read time)	80 fps (12.5ms)		30 fps (33.3ms)		16 fps (62.5ms)	
Field of vision, installation distance	Selecting a lens according to the field of vision and installation distance					
Ambient temperature range	Operating: 0 to 50°C Storage: -25 to 65°C (with no icing or condensation)		Operating: 0 to 40°C Storage: -25 to 65°C (with no icing or condensation)			
Ambient humidity range	Operating and storage: 35% to 85% (with no condensation)					
Weight	Approx. 55g		Approx. 76g		Approx. 140g	
Accessories	Instruction manual					

Small Digital Cameras

	FZ-SF	FZ-SFC	FZ-SP	FZ-SPC
Image elements	Interline transfer reading all pixels, 1/3-inch CCD image elements			
Color/Monochrome	Monochrome	Color	Monochrome	Color
Effective pixels	640(H)×480(V)			
Pixel size	7.4(μm)×7.4(μm)			
Shutter function	Electronic shutter; select shutter speeds from 1/10 to 1/50,000 s			
Partial function	12 to 480 lines			
Frame rate (image read time)	80 fps (12.5ms)			
Field of vision, installation distance	Selecting a lens according to the field of vision and installation distance			
Ambient temperature range	Operating: 0 to 50°C (camera amp) 0 to 45°C (camera head) Storage: -25 to 65°C (with no icing or condensation)			
Ambient humidity range	Operating and storage: 35% to 85% (with no condensation)			
Weight	Approx. 150 g			
Accessories	Instruction manual, installation bracket, Four mounting brackets (M2)		Instruction manual	

High-speed Cameras

	FZ-SH	FZ-SHC
Image elements	Interline transfer reading all pixels, 1/3-inch CCD image elements	
Color/Monochrome	Monochrome	Color
Effective pixels	640(H)×480(V)	
Pixel size	7.4(μm)×7.4(μm)	
Shutter function	Electronic shutter; select shutter speeds from 1/10 to 1/50,000 s	
Partial function	12 to 480 lines	
Frame rate (image read time)	204 fps (4.9ms)	
Field of vision, installation distance	Selecting a lens according to the field of vision and installation distance	
Ambient temperature range	Operating: 0 to 40°C Storage: -25 to 65°C (with no icing or condensation)	
Ambient humidity range	Operating and storage: 35% to 85% (with no condensation)	
Weight	Approx. 105 g	
Accessories	Instruction manual	

Intelligent Compact Cameras

	FZ-SQ010F	FZ-SQ050F	FZ-SQ100F	FZ-SQ100N
Image elements	1/3-inch CMOS image elements			
Color/Monochrome	Color			
Effective pixels	752(H)×480(V)			
Pixel size	6.0(μm)×6.0(μm)			
Shutter function	1/250 to 1/32,258			
Partial function	8 to 480 lines			
Frame rate (image read time)	60 fps			
Field of vision	7.5×4.7 to 13×8.2 mm	13×8.2 to 53×33 mm	53×33 to 240×153 mm	29×18 to 300×191 mm
Installation distance	38 to 60 mm	56 to 215 mm	220 to 970 mm	32 to 380 mm
LED class (See note)	Class 2			
Ambient temperature range	Operating: 0 to 50°C Storage: -25 to 65°C			
Ambient humidity range	Operating and storage: 35% to 85% (with no condensation)			
Weight	Approx. 150 g		Approx. 140 g	
Accessories	Mounting bracket (FQ-XL), polarizing filter attachment (FQ-XF1), instruction manual and warning label			

Note : Applicable standards: IEC62471-2

Ratings and Specifications (LCD Monitor, Cable)

LCD Monitor

	FZ-M08
Size	8.4 inches
Type	Liquid crystal color TFT
Resolution	1,024 × 768 dots
Input signal	Analog RGB video input, 1 channel
Power supply voltage	21.6 to 26.4 VDC
Current consumption	Approx. 0.7 A max.
Ambient temperature range	Operating: 0 to 50°C; Storage: -25 to 65°C (with no icing or condensation)
Ambient humidity range	Operating and storage: 35 to 85% (with no condensation)
Weight	Approx. 1.2 kg
Accessories	Instruction Sheet and 4 mounting brackets

Camera Cables

	FZ-VS3 (2m)	FZ-VSB3 (2m)	FZ-VSL3 (2m)	FZ-VSLB3 (2m)
Type	Standard	Bend resistant	Right-angle	Bend resistant Right-angle
Shock resistiveness (durability)	10 to 150 Hz single amplitude 0.15 mm 3 directions, 8 strokes, 4 times			
Ambient temperature range	Operation and storage: 0 to 65°C (with no icing or condensation)			
Ambient humidity range	Operation and storage: 40 to 70%RH (with no condensation)			
Ambient atmosphere	No corrosive gases			
Material	Cable sheath, connector: PVC			
Minimum bending radius	69 mm	69 mm	69 mm	69 mm
Weight	approx. 170 g	approx. 180 g	approx. 170 g	approx. 180 g

Monitor Cable

	FZ-VM
Vibration resistiveness	10 to 150Hz single amplitude 0.15 mm 3 directions, 8 strokes, 4 times
Ambient temperature range	Operation: 0 to 50°C; Storage: -20 to +65°C (with no icing or condensation)
Ambient humidity range	Operation and storage: 35 to 85%RH (with no condensation)
Ambient atmosphere	No corrosive gases
Material	Cable sheath: heat-resistant PVC Connector: PVC
Minimum bending radius	75 mm
Weight	approx. 170 g

Cable Extension Unit

	FZ-VSJ
Power supply voltage (See note 1.)	11.5 to 13.5 VDC
Current consumption (See note 2.)	1.5 A max.
Ambient temperature range	Operating: 0 to 50°C; Storage: -25 to 65°C (with no icing or condensation)
Ambient humidity range	Operating and storage: 35 to 85% (with no condensation)
Maximum Units connectable	2 Units per Camera
Weight	Approx. 240 g
Accessories	Instruction Sheet and 4 mounting screws

Note 1: A 12-VDC power supply must be provided to the Cable Extension Unit when connecting the Intelligent Compact Camera, the Strobe Controller, or the Lighting Controller.

2: The current consumption shows when connecting the Cable Extension Unit to an external power supply.

Long-distance Camera Cables

	FZ-VS4 (15m)	FZ-VSL4 (15m)
Type	Standard	Right-angle
Shock resistiveness (durability)	10 to 150 Hz single amplitude 0.15 mm 3 directions, 8 strokes, 4 times	
Ambient temperature range	Operation and storage: 0 to 65°C (with no icing or condensation)	
Ambient humidity range	Operation and storage: 40 to 70%RH (with no condensation)	
Ambient atmosphere	No corrosive gases	
Material	Cable sheath, connector: PVC	
Minimum bending radius	78 mm	
Weight	approx. 1400 g	

Parallel Cable

	FZ-VP	FZ-VPX
Vibration resistiveness	10 to 150 Hz single amplitude 0.15 mm 3 directions, 8 strokes, 4 times	
Ambient temperature range	Operation: 0 to 50°C; Storage: -20 to 65°C (with no icing or condensation)	
Ambient humidity range	Operation and storage: 35 to 85%RH (with no condensation)	
Ambient atmosphere	No corrosive gases	
Material	Cable sheath: heat-resistant PVC Connector: resin	
Minimum bending radius	75 mm	
Weight	approx. 160 g	approx. 180 g

Connection Table

Camera Connection Table

Type of camera	Model	Resolution	FZ4 series			
			Quad Processing High-speed Controllers FZ4-11 □	High-speed Controllers FZ4-7 □	Standard Controllers FZ4-6 □	Lite Controllers FZ4-L35 □
Digital cameras	FZ-SC	300,000 Pixels	Yes	Yes	Yes	Yes
	FZ-S	300,000 Pixels	Yes	Yes	Yes	Yes
	FZ-SC2M	2 million pixels	Yes	Yes	Yes	Yes
	FZ-S2M	2 million pixels	Yes	Yes	Yes	Yes
	FZ-SC5M2	5 million pixels	Yes	Yes (See note1.)	Yes (See note1.)	Yes (See note1.)
	FZ-S5M2	5 million pixels	Yes	Yes (See note1.)	Yes (See note1.)	Yes (See note1.)
High-speed cameras	FZ-SHC	300,000 Pixels	Yes	Yes	Yes	Yes
	FZ-SH	300,000 Pixels	Yes	Yes	Yes	Yes
Small digital cameras	FZ-SFC	300,000 Pixels	Yes	Yes	Yes	Yes
	FZ-SF	300,000 Pixels	Yes	Yes	Yes	Yes
	FZ-SPC	300,000 Pixels	Yes	Yes	Yes	Yes
	FZ-SP	300,000 Pixels	Yes	Yes	Yes	Yes
Intelligent compact cameras	FZ-SQ010F	360,000 Pixels	Yes	Yes	Yes	Yes
	FZ-SQ050F	360,000 Pixels	Yes	Yes	Yes	Yes
	FZ-SQ100F	360,000 Pixels	Yes	Yes	Yes	Yes
	FZ-SQ100N	360,000 Pixels	Yes	Yes	Yes	Yes

Note 1: When connecting 5 million-pixel cameras, up to two cameras can be connected.

Cameras / Cables Connection Table

Type of camera	Model	Cable length	High-speed cameras	Digital cameras			Small digital cameras Pen type / flat type	Intelligent compact cameras
				300,000-pixel	2 million-pixel	5 million-pixel		
Camera Cables Right-angle camera cables	FZ-VS3 FZ-VSL3	2m	Yes	Yes	Yes	Yes	Yes	Yes
		3m	Yes	Yes	Yes	Yes	Yes	Yes
		5m	Yes	Yes	Yes	Yes	Yes	Yes
		10m	Yes	Yes	Yes	No	Yes	Yes
Bend resistant camera cables Bend resistant right-angle camera cables	FZ-VSB3 FZ-VSLB3	2m	Yes	Yes	Yes	Yes	Yes	Yes
		3m	Yes	Yes	Yes	Yes	Yes	Yes
		5m	Yes	Yes	Yes	Yes	Yes	Yes
	10m	Yes	Yes	Yes	No	Yes	Yes	
Long-distance camera cable Long-distance right-angle camera cable	FZ-VS4 FZ-VSL4	15m	Yes	Yes	Yes	No	Yes	Yes

Processing Items

* The items in red are High Grade processing items.

Group	Icon	Processing Item	Corresponding Page in the Catalog
Inspections / Measurement		Search Used to identify the shapes and calculate the position of measurement objects.	
		Flexible Search Recognizing the shapes of workpieces with variation and detecting their positions.	P20
		Sensitive Search Search a small difference by dividing the search model in detail, and calculating the correlation.	P20
		ECM Search Used to search the similar part of model form input image. Detect the evaluation value and position.	
		Ec Circle Search Extract circles using "round" shape information and get position, radius and quantity in high preciseness.	
		Shape Search+ Used to Search the similar part of models from input image. Detect the evaluation value and position.	
		Shape Search II Used to search the similar part of model from input image regardless of environmental changes. Detect the evaluation value and position.	P6
		Classification Used when various kinds of products on the assembly line need to be sorted and identified.	
		Edge Position Measure position of measurement objects according to the color change in measurement area.	
		Edge Pitch Detect edges by color change in measurement area. Used for calculating number of pins of IC and connectors.	
		Scan Edge Position Measure peak/bottom edge position of workpieces according to the color change in separated measurement area.	
		Scan Edge Width Measure max/min/average width of workpieces according to the color change in separated measurement area.	
		Circular Scan Edge Position Measure center axis, diameter and radius of circular workpieces.	P20
		Circular Scan Edge Width Measure center axis, width and thickness of ring workpieces.	P20
		Color Data Used for detecting presence and mixed varieties of products by using color average and deviation.	
		Gravity and Area Used to measure area, center of gravity of workpieces by extracting the color to be measured.	
		Labeling Used to measure number, area and gravity of workpieces by extracting registered color.	
		Label Data Selecting one region of extracted Labeling, and get that measurement. Area and Gravity position can be got and judged.	
		Labeling+ Extract objects of registered color, and measure many features such as number and circularity.	
		Defect Used for appearance measurement of plain-color measurement objects such as defects, stains and burrs.	
		PreciseDefect Check the defect on the object. Parameters for extraction defect can be set precisely.	P21
		Fine Matching Difference can be detected by overlapping and comparing (matching) registered fine images with input images.	P21
		Character Inspection Recognize character according correlation search with model image registered in [Model Dictionary].	
		Date Verification Reading character string is verified with internal date.	
		Model Dictionary Register character pattern as dictionary. The pattern is used in [Character Inspection].	
		Barcode+ *1 Recognize barcode, verify and output decoded characters.	
		2DCode *2 Recognize 2D code and display where the code quality is poor.	P21
		2DCode+ *2 Recognize 2D code, verify and output decoded characters.	
	Circle Angle Used for calculating angle of inclination of circular measurement objects.		
Image Capturing		Camera Image Input To input images from cameras. And set up the conditions to input images from cameras.	
		Camera Image Input HDR Create high-dynamic range images by acquiring several images with different conditions.	P19
		Camera Image Input HDR Lite HDR function for FZ-SQ□ Intelligent Compact Cameras.	
		Camera Switching To switch the cameras used for measurement. Not input images from cameras again.	
	Measurement Image Switching To switch the images used for measurement. Not input images from camera again.		
Correcting images		Position Compensation Used when positions are differed. Correct measurement is performed by correcting position of input images.	
		Trapezoidal Correction+ Rectify the trapezoidal deformed image.	P12
		Filtering Used for processing images input from cameras in order to make them easier to be measured.	

Group	Icon	Processing Item	Corresponding Page in the Catalog
Correcting images		Background Suppression To enhance contrast of images by extracting color in specified brightness.	
		Brightness Correct Filter Track brightness change of entire screen and remove gradual brightness change such as uneven brightness.	P15
		Color Gray Filter Color image is converted into monochrome images to emphasize specific color.	
		Extract Color Filter Convert color image to color extracted image or binary image.	
		Anti Color Shading To remove the irregular color/pattern by uniformizing max.2 specified colors.	
		Stripes Removal Filter+ Remove the background pattern of vertical, horizontal and cross stripes.	
		Stripes Removal Filter II Remove the background pattern of vertical, horizontal and diagonal stripes.	P18
		Halation Cut+ Remove halation from input image.	
		Panorama+ Combine multiple image to create one big image.	
		Polar Transformation Rectify the image by polar transformation. Useful for OCR or pattern inspection printed on circle.	
		Calculation Used when using the judge results and measured values of Procltem which are registered in processing units.	
		Line Regression Used for calculating regression line from plural measurement coordinate.	
		Circle Regression Used for calculating regression circle from plural measurement coordinate.	
		Calibration+ Transform (X,Y) position to the real coordinate system.	
Assisting inspections / measurement		Precise Calibration Used for calibration corresponding to trapezoidal distortion and lens distortion.	P18
		User Data Used for setting of the data that can be used as common constants and variables in scene group data.	
		Set Unit Data Used to change the Procltem data (setting parameters, etc.) that has been set up in a scene.	
		Get Unit Data Used to get one data (measured results, setting parameters, etc.) of Procltem that has been set up in a scene.	
		Set Unit Figure Used for re-setting the figure data (model, measurement area) registered in an unit.	
		Get Unit Figure Used for get the figure data (model, measurement area) registered in an unit.	
		Trend Monitor Used for displaying the information about results on the monitor, facilitating to avoid NG and analyze causes.	
		Image Logging Used for saving the measurement images to the memory and USB memory.	
		Image Conversion Logging Used for saving the measurement images in JPEG and BMP format.	P15
		Data Logging Used for saving the measurement data to the memory and USB memory.	
		Elapsed Time Used for calculating the elapsed time since the measurement trigger input.	
		Wait Processing is stopped only at the set time. The standby time is set by the unit of [ms].	
		Focus Focus setting is supported.	P19
		Iris Focus and aperture setting is supported.	P19
Branching processing		Conditional Branch Used where more than two kinds of products on the production line need to detected separately.	
		End This Procltem must be set up as the last processing unit of a branch.	
Outputting results		DI Branch Same as Procltem "Branch". But you can change the targets of conditional branching via external inputs.	
		Data Output Used when you need to output data to the external devices such as PLC or PC via serial ports.	P19
		Parallel Data Output Used when you need to output data to the external devices such as PLC or PC via parallel ports.	
		Parallel Judgement Output Used when you need to output judgement results to the external devices such as PLC or PC via parallel ports.	
		Fieldbus Data Output Outputs data to an external device, such as a Programmable Controller, through a fieldbus interface.	
Displaying results on the monitor		Result Display Used for displaying the texts or the figures in the camera image.	
		Display Image File Display selected image file.	
		Display Last NG Image Display the last NG images.	P19

*1. Bar Codes that can be read : JAN/EAN/UPC (including add-on codes), Code 39, Codabar (NW-7), ITF (Interleaved 2 of 5), Code 93, Code 128, GS1-128, GS1 DataBar (RSS-14 / RSS Limited / RSS Expanded), Pharmacoode
 *2. 2D Codes that can be read : Data Matrix (ECC200), QR Code

External Dimensions (Unit:mm)

FZ4-series Controllers

■ LCD-integrated type

- FZ4-H110□/□-H110□□-10
- FZ4-110□/□-110□□-10
- FZ4-H70□/□-H70□□-10
- FZ4-70□/□-70□□-10
- FZ4-H60□/□-H60□□-10
- FZ4-60□/□-60□□-10

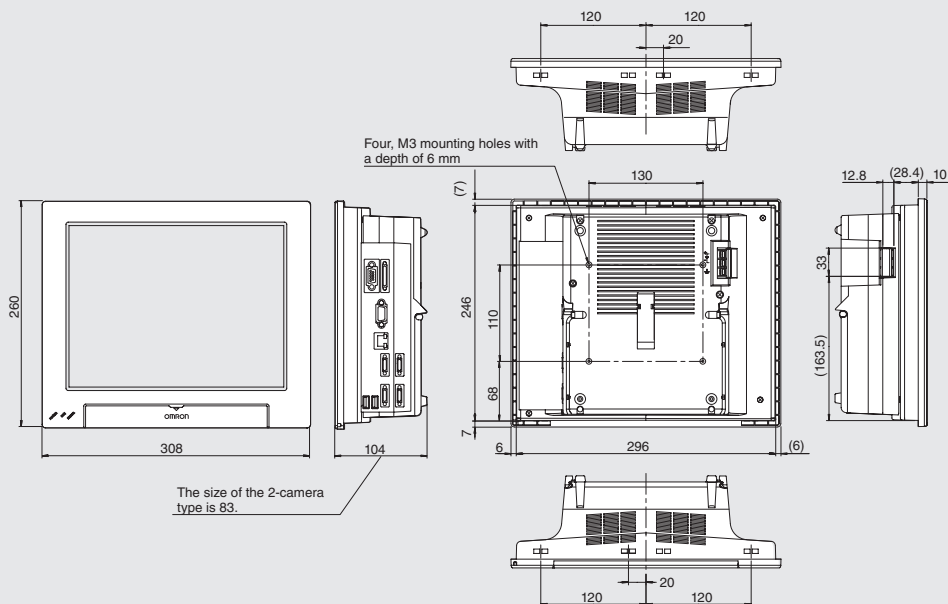

■ Box-type

- FZ4-H115□/□-H115□□-10
- FZ4-115□/□-115□□-10
- FZ4-H75□/□-H75□□-10
- FZ4-75□/□-75□□-10
- FZ4-H65□/□-H65□□-10
- FZ4-65□/□-65□□-10

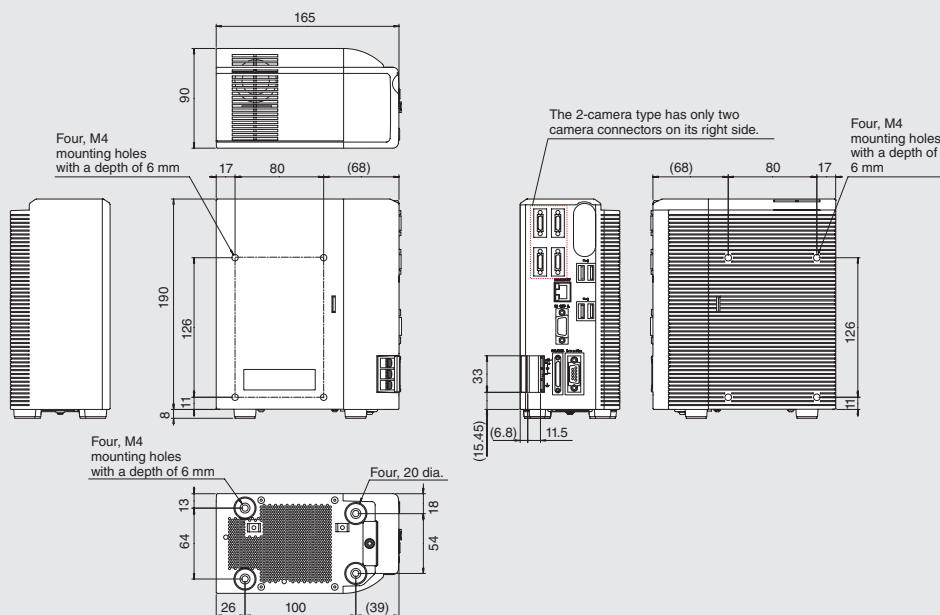

FZ4-L35□/□-L35□□-10

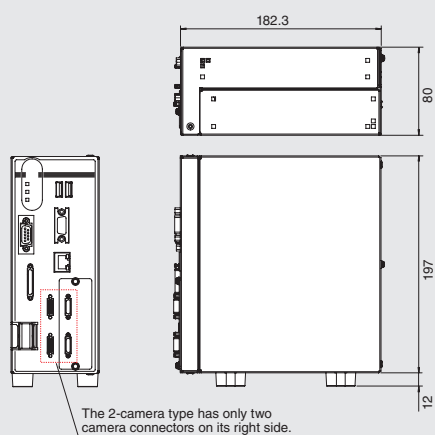

Cameras

Digital Cameras

■ 300,000-pixel camera

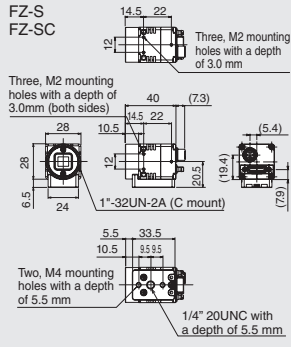

■ 2 million-pixel camera

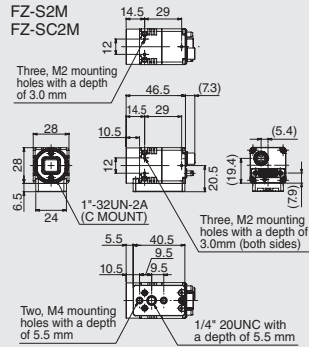

■ 5 million-pixel camera

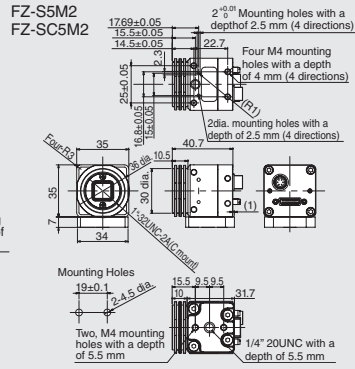

■ High-speed Camera

FZ-SH FZ-SHC

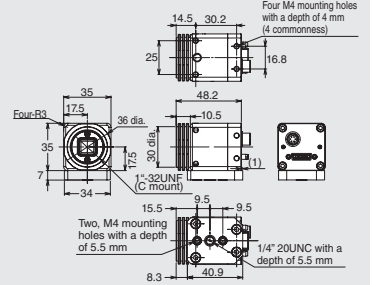

Small digital cameras

■ Camera head

Flat camera

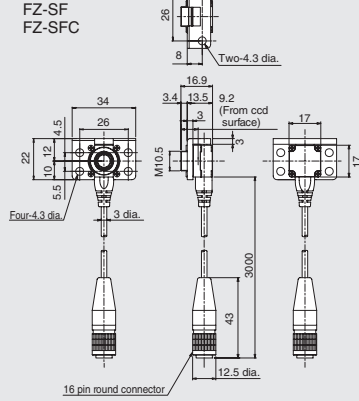

Pen-shaped camera

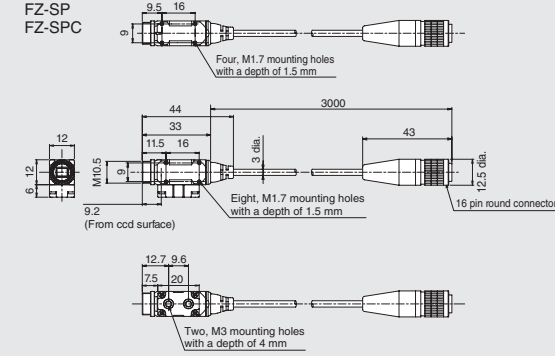

■ Camera amplifier

Can be used for both flat cameras and pen-shaped cameras

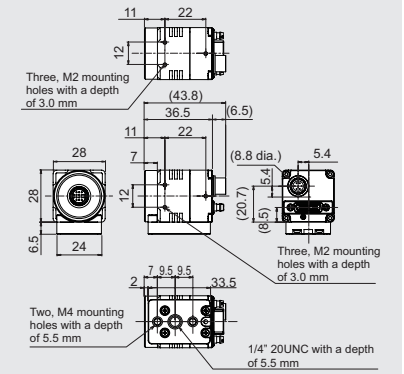

■ Intelligent Compact Cameras (Dimensional drawings are provided here only for the products that have undergone design changes as of Dec. 2012.)

Narrow view / Standard

FZ-SQ10F FZ-SQ050F

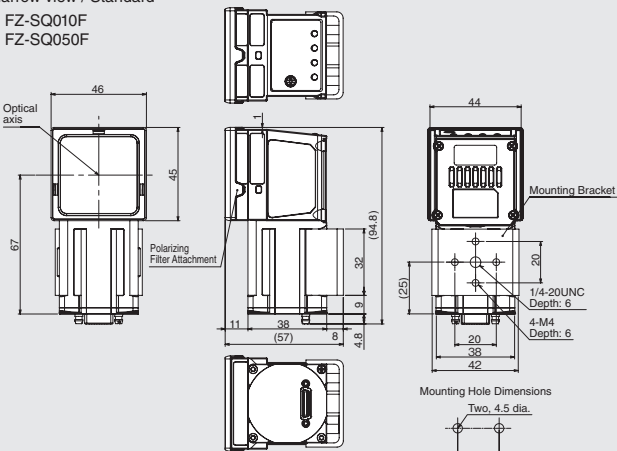

Note 1: The mounting brackets can be connected to either side.

Tightening torque: 1.2 N·m

Wide View

FZ-SQ100F (long-distance) FZ-SQ100N (short-distance)

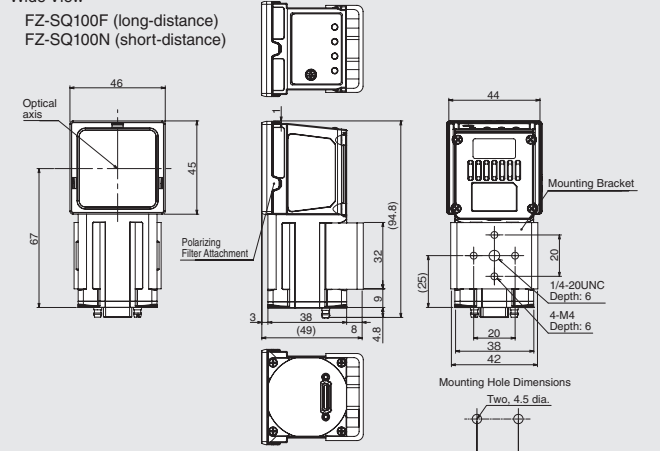

Note 1: The mounting brackets can be connected to either side.

Tightening torque: 1.2 N·m

Cables

Camera Cables

■ **Camera Cable**

FZ-VS3

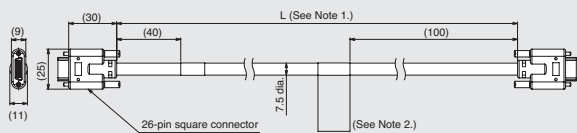

■ **Bend resistant Camera Cable**

FZ-VSB3

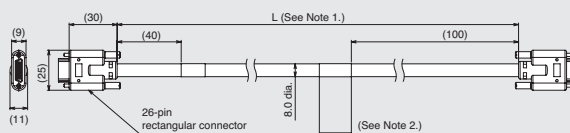

■ **Right-angle Camera Cable**

FZ-VSL3

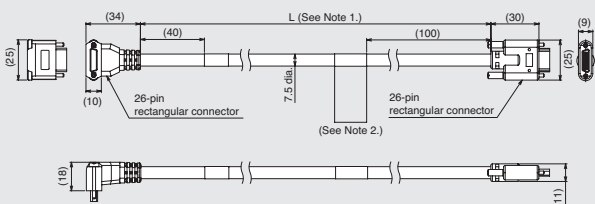

■ **Bend resistant Right-angle Camera Cable**

FZ-VSLB3

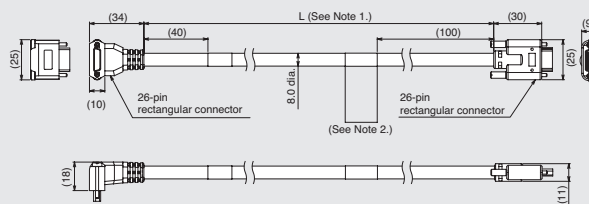

■ **Long-distance Camera Cable**

FZ-VS4

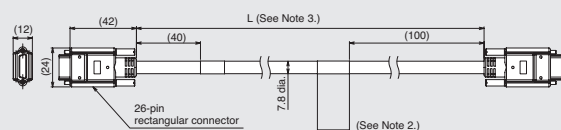

■ **Long-distance Right-angle Camera Cable**

FZ-VSL4

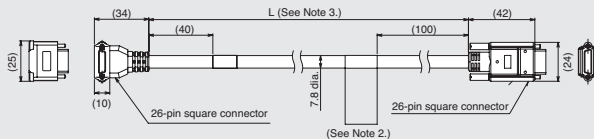

- Note 1: Cable is available in 2m/3m/5m/10m.
- Note 2: Each camera cables has polarity. Please ensure that the name plate side of the cable is connected to the controller.
- Note 3: Cable is available in 15m.

Parallel Cable

FZ-VP

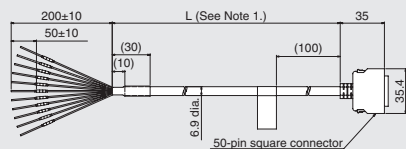

FZ-VPX

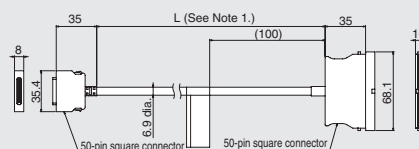

Note 1: cable is available in 2m/5m.

Note 1: cable is available in 2m/5m.

Monitor Cable

FZ-VM

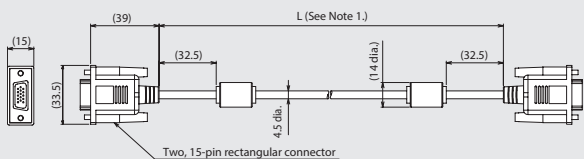

Note 1: Cable is available in 2m/5m.

LCD Monitor

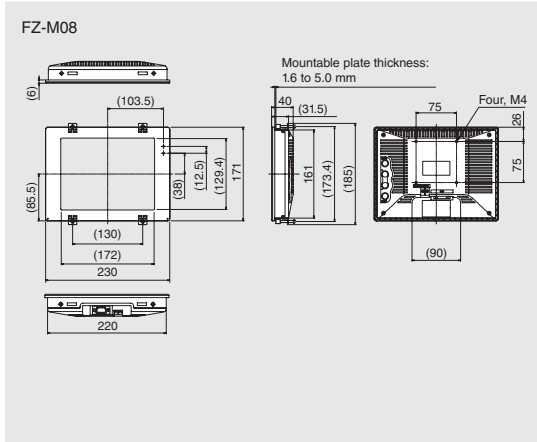

Camera Cable Extension Unit

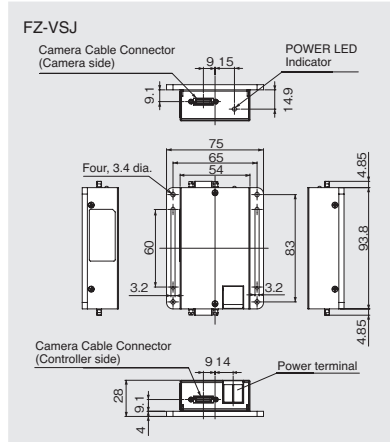

Extension Tubes for Small Camera

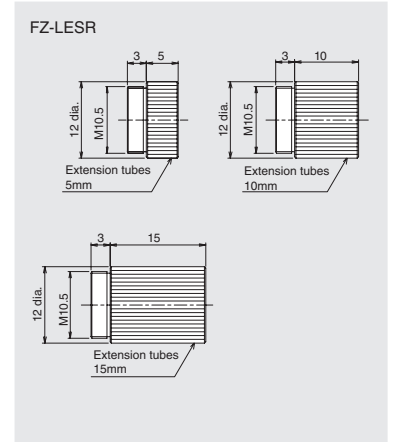

Lens for Small Camera

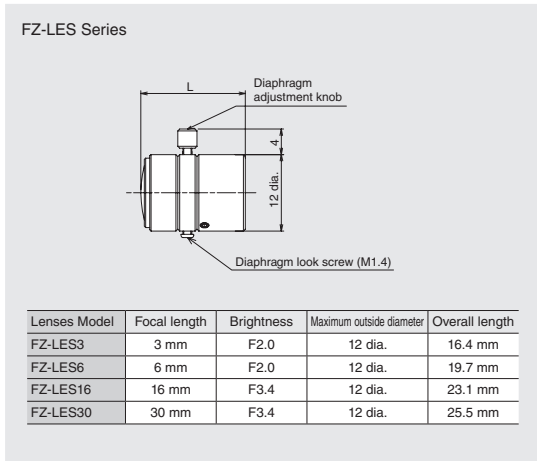

Optical Chart

5 million-pixel digital camera FZ-S□5M2

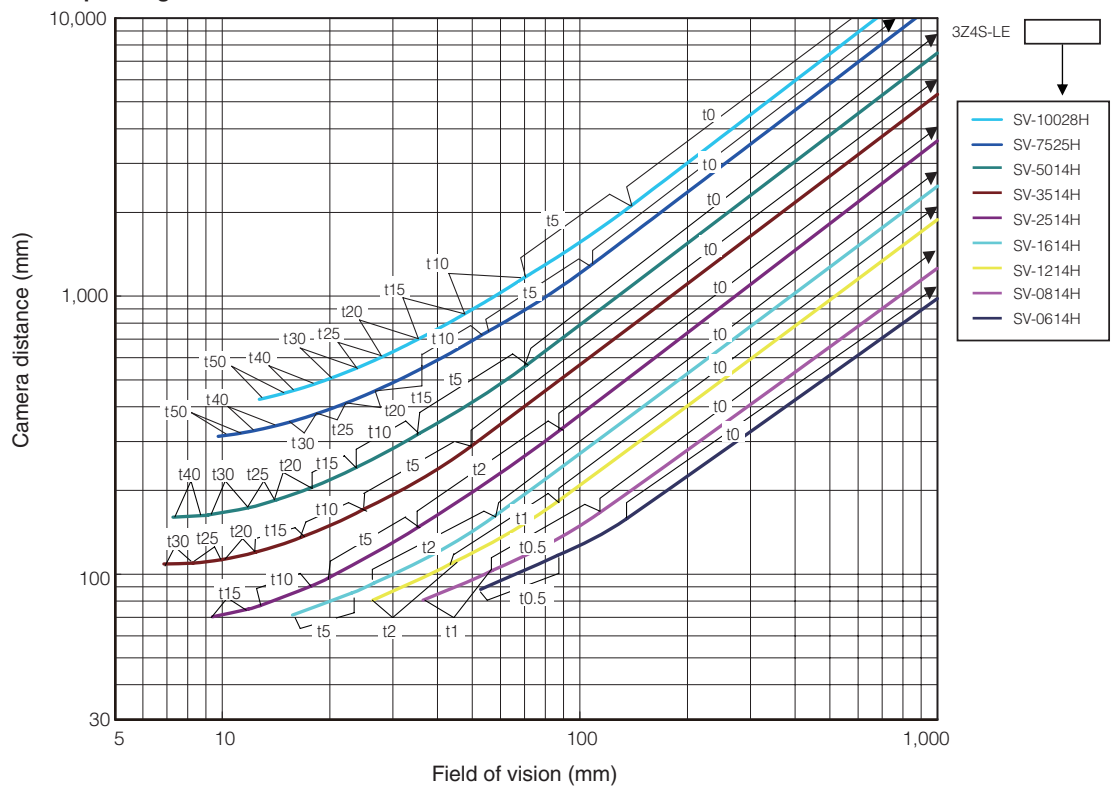

2 million-pixel digital camera FZ-S□2M

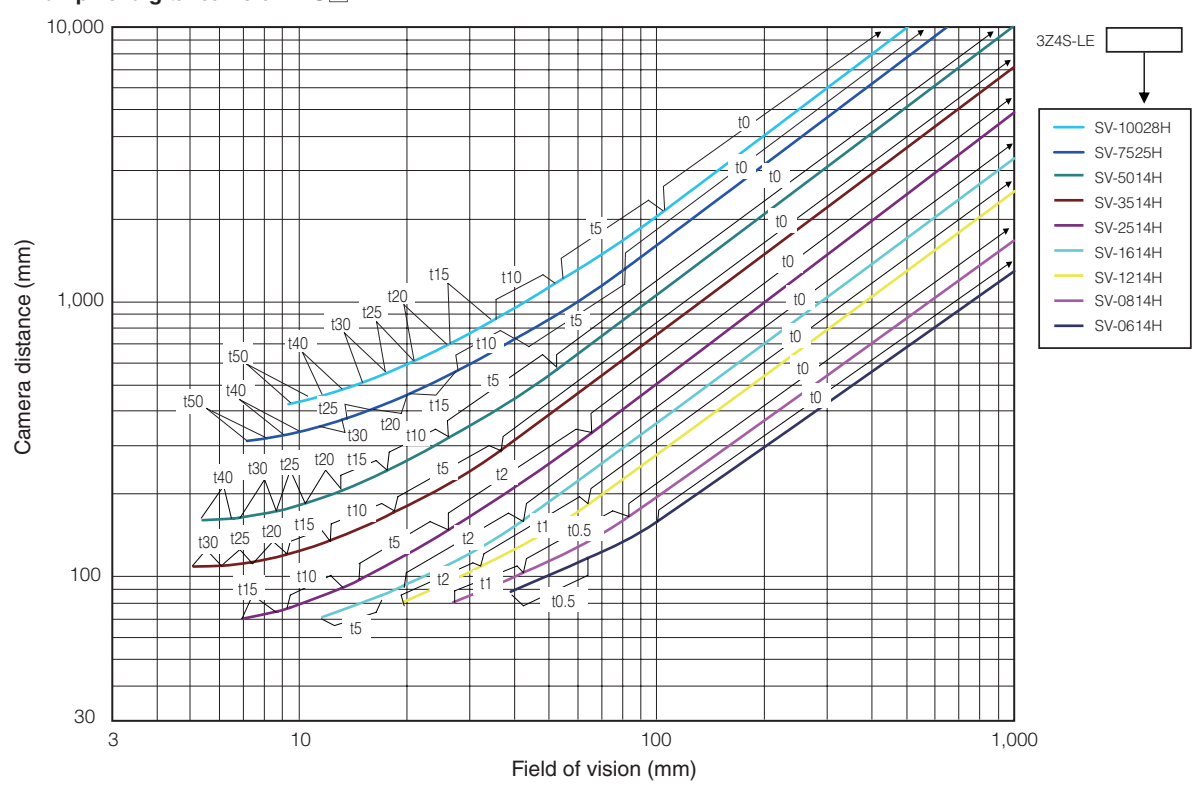

300,000-pixel High-speed camera FZ-SH □, and Digital camera FZ-S □

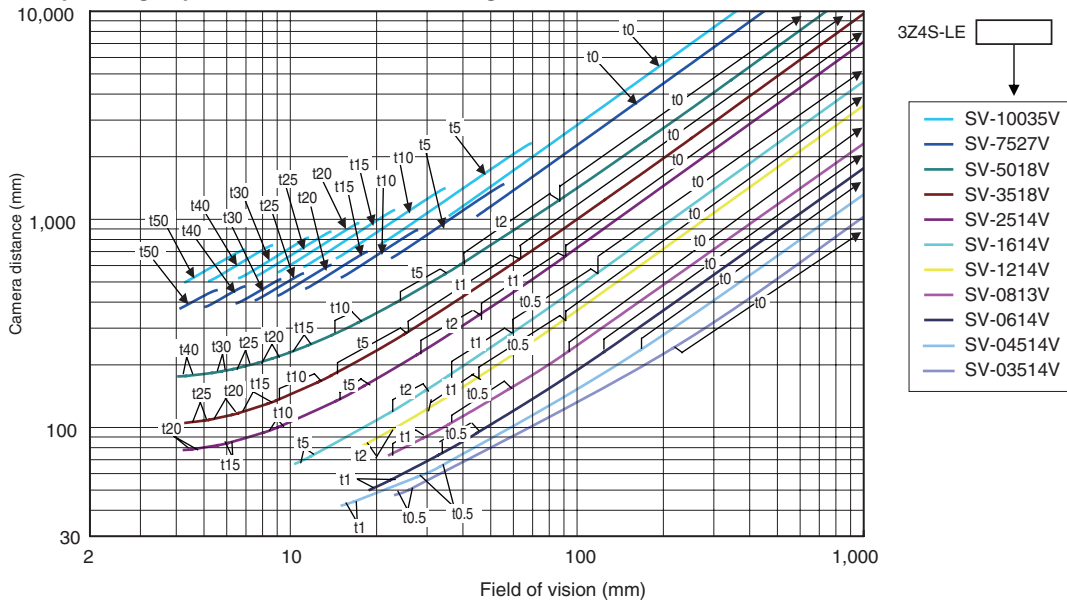

300,000-pixel small digital cameras FZ-SF □, FZ-SP □

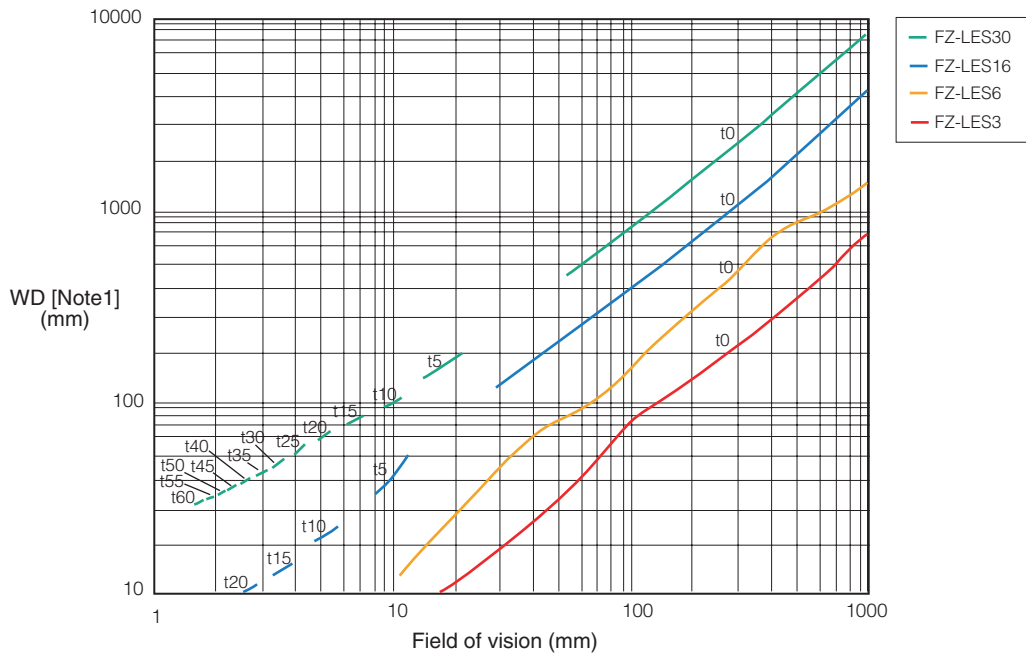

Note 1: The vertical axis represents WD, not installation distance.

■ Meaning of Optical Chart

The X axis of the optical chart shows the field of vision (mm) (See Note 1.), and the Y axis of the optical chart shows the camera installation distance (mm) (See Note 2.).

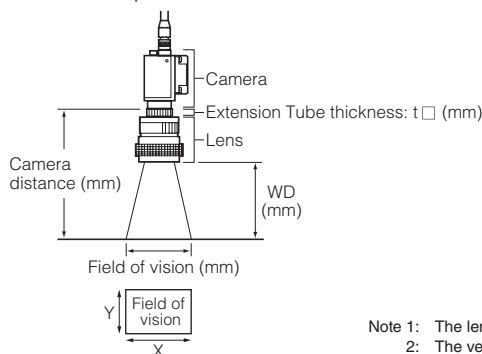

Note 1: The lengths of the fields of vision given in the optical charts are the lengths of the Y axis.
 Note 2: The vertical axis represents WD for small cameras.

Intelligent Compact Cameras

(Unit: mm)

■ Narrow View

FZ-SQ010F

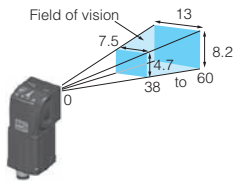

■ Standard

FZ-SQ050F

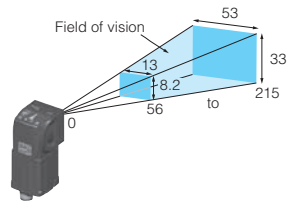

■ Wide View (Long-distance)

FZ-SQ100F

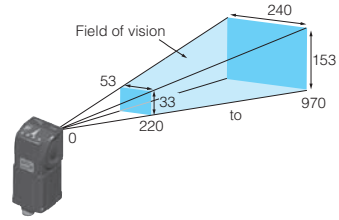

■ Wide View (Short-distance)

FZ-SQ100N

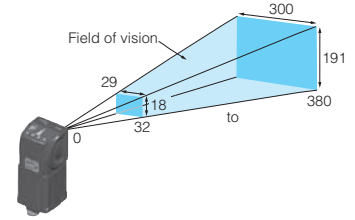

READ AND UNDERSTAND THIS CATALOG

Please read and understand this catalog before purchasing the products. Please consult your OMRON representative if you have any questions or comments.

WARRANTY

OMRON's exclusive warranty is that the products are free from defects in materials and workmanship for a period of one year (or other period if specified) from date of sale by OMRON.

OMRON MAKES NO WARRANTY OR REPRESENTATION, EXPRESS OR IMPLIED, REGARDING NON-INFRINGEMENT, MERCHANTABILITY, OR FITNESS FOR PARTICULAR PURPOSE OF THE PRODUCTS. ANY BUYER OR USER ACKNOWLEDGES THAT THE BUYER OR USER ALONE HAS DETERMINED THAT THE PRODUCTS WILL SUITABLY MEET THE REQUIREMENTS OF THEIR INTENDED USE. OMRON DISCLAIMS ALL OTHER WARRANTIES, EXPRESS OR IMPLIED.

LIMITATIONS OF LIABILITY

OMRON SHALL NOT BE RESPONSIBLE FOR SPECIAL, INDIRECT, OR CONSEQUENTIAL DAMAGES, LOSS OF PROFITS OR COMMERCIAL LOSS IN ANY WAY CONNECTED WITH THE PRODUCTS, WHETHER SUCH CLAIM IS BASED ON CONTRACT, WARRANTY, NEGLIGENCE, OR STRICT LIABILITY.

In no event shall responsibility of OMRON for any act exceed the individual price of the product on which liability is asserted.

IN NO EVENT SHALL OMRON BE RESPONSIBLE FOR WARRANTY, REPAIR, OR OTHER CLAIMS REGARDING THE PRODUCTS UNLESS OMRON'S ANALYSIS CONFIRMS THAT THE PRODUCTS WERE PROPERLY HANDLED, STORED, INSTALLED, AND MAINTAINED AND NOT SUBJECT TO CONTAMINATION, ABUSE, MISUSE, OR INAPPROPRIATE MODIFICATION OR REPAIR.

SUITABILITY FOR USE

THE PRODUCTS CONTAINED IN THIS DOCUMENT ARE NOT SAFETY RATED. THEY ARE NOT DESIGNED OR RATED FOR ENSURING SAFETY OF PERSONS, AND SHOULD NOT BE RELIED UPON AS A SAFETY COMPONENT OR PROTECTIVE DEVICE FOR SUCH PURPOSES. Please refer to separate catalogs for OMRON's safety rated products.

OMRON shall not be responsible for conformity with any standards, codes, or regulations that apply to the combination of products in the customer's application or use of the product.

At the customer's request, OMRON will provide applicable third party certification documents identifying ratings and limitations of use that apply to the products. This information by itself is not sufficient for a complete determination of the suitability of the products in combination with the end product, machine, system, or other application or use.

The following are some examples of applications for which particular attention must be given. This is not intended to be an exhaustive list of all possible uses of the products, nor is it intended to imply that the uses listed may be suitable for the products:

- Outdoor use, uses involving potential chemical contamination or electrical interference, or conditions or uses not described in this document.
- Nuclear energy control systems, combustion systems, railroad systems, aviation systems, medical equipment, amusement machines, vehicles, safety equipment, and installations subject to separate industry or government regulations.
- Systems, machines, and equipment that could present a risk to life or property.

Please know and observe all prohibitions of use applicable to the products.

NEVER USE THE PRODUCTS FOR AN APPLICATION INVOLVING SERIOUS RISK TO LIFE OR PROPERTY WITHOUT ENSURING THAT THE SYSTEM AS A WHOLE HAS BEEN DESIGNED TO ADDRESS THE RISKS, AND THAT THE OMRON PRODUCT IS PROPERLY RATED AND INSTALLED FOR THE INTENDED USE WITHIN THE OVERALL EQUIPMENT OR SYSTEM.

PERFORMANCE DATA

Performance data given in this document is provided as a guide for the user in determining suitability and does not constitute a warranty. It may represent the result of OMRON's test conditions, and the users must correlate it to actual application requirements. Actual performance is subject to the OMRON Warranty and Limitations of Liability.

CHANGE IN SPECIFICATIONS

Product specifications and accessories may be changed at any time based on improvements and other reasons.

It is our practice to change model numbers when published ratings or features are changed, or when significant construction changes are made. However, some specifications of the product may be changed without any notice. When in doubt, special model numbers may be assigned to fix or establish key specifications for your application on your request. Please consult with your OMRON representative at any time to confirm actual specifications of purchased products.

DIMENSIONS AND WEIGHTS

Dimensions and weights are nominal and are not to be used for manufacturing purposes, even when tolerances are shown.

ERRORS AND OMISSIONS

The information in this document has been carefully checked and is believed to be accurate; however, no responsibility is assumed for clerical, typographical, or proofreading errors, or omissions.

PROGRAMMABLE PRODUCTS

OMRON shall not be responsible for the user's programming of a programmable product, or any consequence thereof.

COPYRIGHT AND COPY PERMISSION

This document shall not be copied for sales or promotions without permission.

This document is protected by copyright and is intended solely for use in conjunction with the product. Please notify us before copying or reproducing this document in any manner, for any other purpose. If copying or transmitting this document to another, please copy or transmit it in its entirety.

Note: Do not use this document to operate the Unit.

OMRON Corporation **Industrial Automation Company**
Tokyo, JAPAN

Contact: www.ia.omron.com

Regional Headquarters

OMRON EUROPE B.V.
Wegalaan 67-69-2132 JD Hoofddorp
The Netherlands
Tel: (31)2356-81-300/Fax: (31)2356-81-388

OMRON ASIA PACIFIC PTE. LTD.
No. 438A Alexandra Road # 05-05/08 (Lobby 2),
Alexandra Technopark,
Singapore 119967
Tel: (65) 6835-3011/Fax: (65) 6835-2711

OMRON ELECTRONICS LLC
One Commerce Drive Schaumburg,
IL 60173-5302 U.S.A.
Tel: (1) 847-843-7900/Fax: (1) 847-843-7787

OMRON (CHINA) CO., LTD.
Room 2211, Bank of China Tower,
200 Yin Cheng Zhong Road,
PuDong New Area, Shanghai, 200120, China
Tel: (86) 21-5037-2222/Fax: (86) 21-5037-2200

Authorized Distributor:

© OMRON Corporation 2011 All Rights Reserved.
In the interest of product improvement,
specifications are subject to change without notice.

CSM_14_2_0417
Cat. No. Q189-E1-02

0812 (1211)