

ITEM	COMPONENT	QTY	MATERIAL
▽	HOUSING	1	LCP E130i, 30% GLASS FILL, UL-94 V-0 COLOUR BLACK
▽	TERMINAL	1	0.15 PHOSPHOR BRONZE Au OVER Pd/Ni IN CONTACT AREA

NOTES:  
 1 POLISHED SURFACE FINISH IN SHADED AREA  
 2 PACKAGING: LOOSE IN BAG  
 3: FOR ALL UNSPECIFIED DIMENSIONS AND NOTES SEE SHEET 1

ADDED GATE ECN NO. E2002-0530 DRWN:FDUGGAN 2001/12/11 CHKD: APPR:	QUALITY SYMBOLS	GENERAL TOLERANCES (UNLESS SPECIFIED)	SCALE 5:1	DESIGN UNITS METRIC	THIRD ANGLE PROJECTION	REVISE ON CAD ONLY
	▽.0	4 PLACES ± --- ± ---	mm	INCH	TITLE	CARD HOLDER
	▽.0	3 PLACES ± --- ± ---	DIMENSION STYLE MM ONLY		MOLEX INCORPORATED	
	▽.0	2 PLACES ± 0.05 ± ---	DRAWN BY MINDORAK DATE 00/05/31		MATERIAL NO. 912360003 DOCUMENT NO. SDA-91236 SHEET NO. 3 OF 6	
REV	DESCRIPTION	1 PLACE ± 0.10 ± ---	CHECKED BY DHANNON DATE 00/07/13		APPROVED BY MWILHITE DATE 00/07/13	
DRAFT WHERE APPLICABLE			THIS DRAWING CONTAINS INFORMATION THAT IS PROPRIETARY TO MOLEX INCORPORATED AND SHOULD NOT BE USED WITHOUT WRITTEN PERMISSION			
MUST REMAIN WITHIN DIMENSIONS			A2			

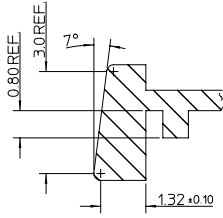
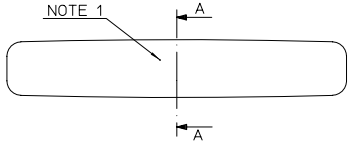

A-A  
SCALE 10:1

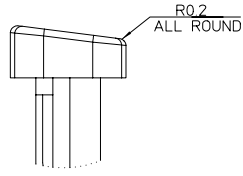

DETAIL A  
SCALE 10:1

ITEM	COMPONENT	QTY	MATERIAL
▽	HOUSING	1	POLYSTER (PBT), 45% GLASS FILL, UL94 V-0 COLOUR BLACK
▽	TERMINAL	1	0.15 PHOSPHOR BRONZE Au OVER Pb/Ni IN CONTACT AREA

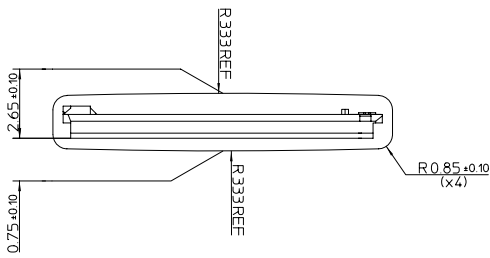
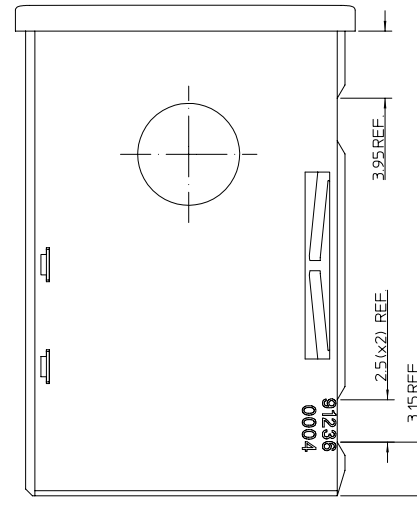
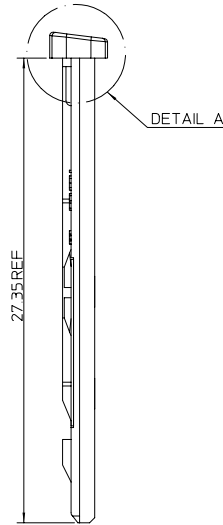
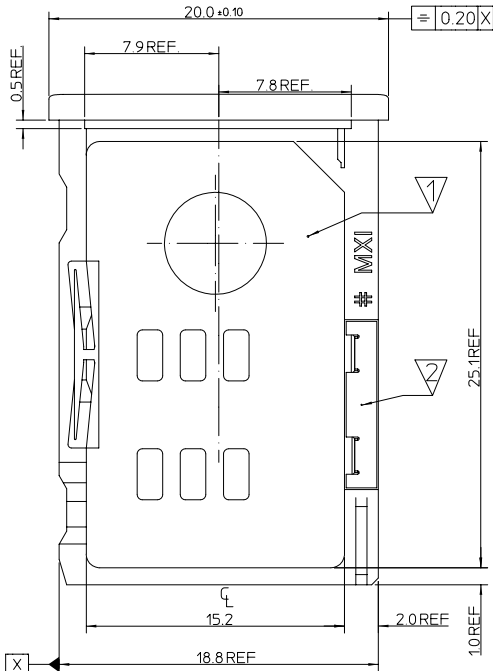

NOTES:

1. VDI 3400 NO. 27 SURFACE FINISH
2. PACKAGING: LOOSE IN BAG
3. FOR ALL UNSPECIFIED DIMENSIONS AND NOTES SEE SHEET 1

EC NO: 2001/12/11 DRWN: FDUGGAN CHKD: 2002/01/04 APPR: BMAGUIRE 2002/01/04	QUALITY SYMBOLS	GENERAL TOLERANCES (UNLESS SPECIFIED)	SCALE 5:1	DESIGN UNITS METRIC	THIRD ANGLE PROJECTION	REVISE ON CAD ONLY
	▽ -0	4 PLACES ± --- ± ---	mm	DIMENSION STYLE MM ONLY	TITLE	CARD HOLDER
	▽ -0	3 PLACES ± --- ± ---	INCH	DRAWN BY MINDORAK	DATE 00/05/31	<b>MOLEX INCORPORATED</b>
	▽ -0	2 PLACES ± 0.05 ± ---		CHECKED BY DHANNON	DATE 00/07/13	
REV	DESCRIPTION	1 PLACE ± 0.10 ± ---	DRAFT WHERE APPLICABLE		APPROVED BY MWILHITE	DATE 00/07/13
		MUST REMAIN WITHIN DIMENSIONS	THIS DRAWING CONTAINS INFORMATION THAT IS PROPRIETARY TO MOLEX INCORPORATED AND SHOULD NOT BE USED WITHOUT WRITTEN PERMISSION		MATERIAL NO. 912360004	DOCUMENT NO. SDA-91236
					SHEET NO. 4 OF 6	A2

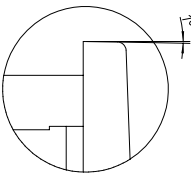
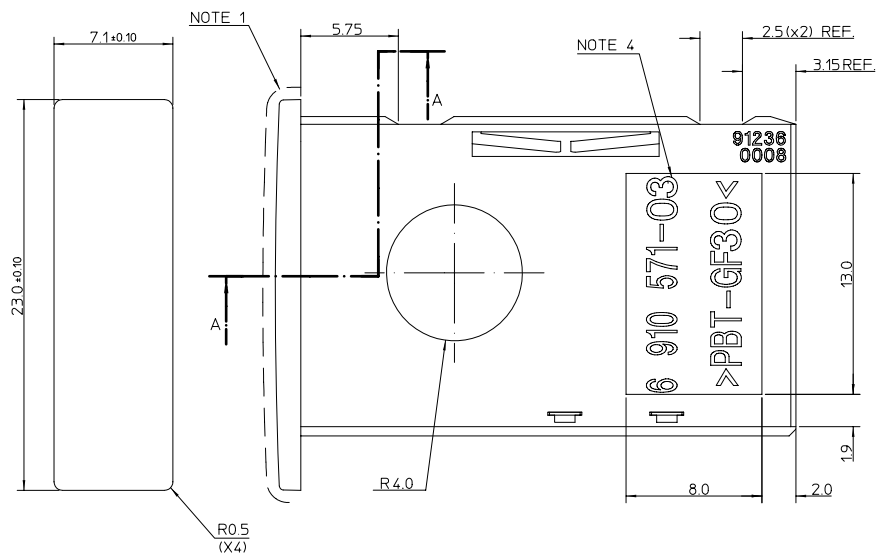
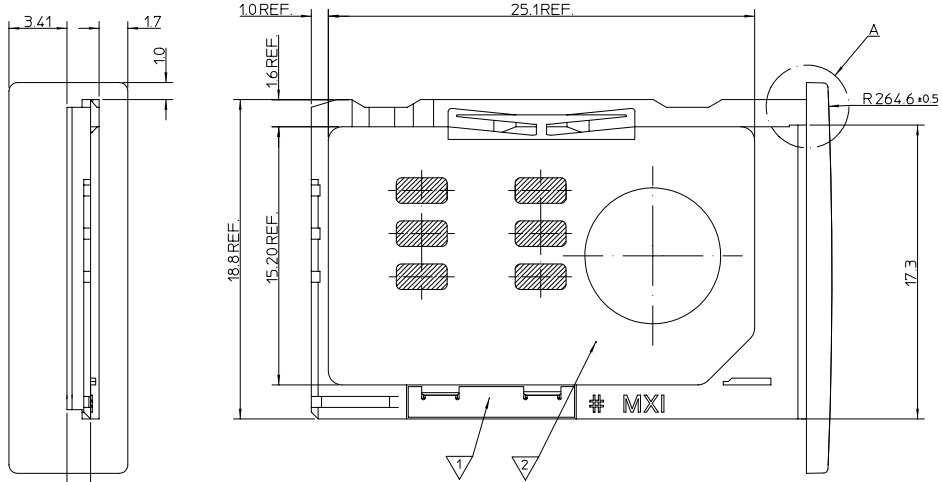

DETAIL A  
(SCALE 10:1)

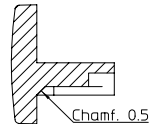
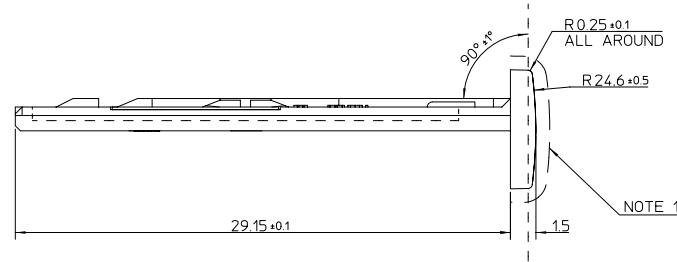

A-A

- NOTES:
1. VISIBLE AREA: NO PARTING LINES PERMISSIBLE IN THIS AREA  
FEINNARBE K (ÄTZSTRUKTUR) SURFACE FINISH
  2. SEE PRODUCT SPECIFICATION: TBD
  3. PACKAGING: LOOSE IN BAG
  4. EXCHANGEABLE INSERT AREA 0.1 RECESSED, LETTERING 0.1 RAISED
  5. FOR ALL UNSPECIFIED DIMENSIONS AND NOTES SEE SHEET 1

ITEM	COMPONENT	QTY	MATERIAL
▽	TERMINAL	1	0.15 PHOSPHOR BRONZE 0.1um MIN Au OVER Pd/Ni IN CONTACT AREA
▽	HOUSING	1	GF PBT, BLACK

EC NO. SEE SHEET 1 DRWN: FUGGAN 2001/12/11 CHKD: 2002/01/04 APPR: BMAGUIRE 2002/01/04	QUALITY SYMBOLS	GENERAL TOLERANCES (UNLESS SPECIFIED)	SCALE 5:1	DESIGN UNITS METRIC	THIRD ANGLE PROJECTION	REVISE ON CAD ONLY
	▽ - 0	4 PLACES ± --- ± --- 3 PLACES ± --- ± --- 2 PLACES ± 0.05 ± --- 1 PLACE ± 0.10 ± ---	mm INCH	DIMENSION STYLE MM ONLY	TITLE	CARD HOLDER
	▽ - 0	ANGULAR ± 2 °	DRAFT WHERE APPLICABLE	DRAWN BY MINDORAK	DATE 00/05/31	
		MUST REMAIN WITHIN DIMENSIONS		CHECKED BY DHANNON	DATE 00/07/13	
			APPROVED BY MWILHITE	DATE 00/07/13	MATERIAL NO. 912360008	DOCUMENT NO. SDA-91236
			THIS DRAWING CONTAINS INFORMATION THAT IS PROPRIETARY TO MOLEX INCORPORATED AND SHOULD NOT BE USED WITHOUT WRITTEN PERMISSION		SHEET NO. 5 OF 6	

13 12 11 10 9 8 7 6 5 4 3 2 1

J I H G F E D C B A

DIMENSION OF SECT A-A IS TAKEN FROM THE INTERSECTION OF THESE CENTRELINES

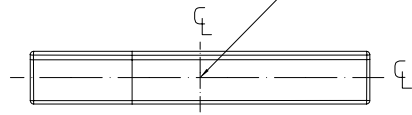

ITEM	COMPONENT	QTY	MATERIAL
1	HOUSING	1	POLYESTER (PBT), 30% GLASS FILL, UL-94 V-0 COLOUR BLACK
2	TERMINAL	1	0.15 PHOSPHER BRONZE Au IN CONTACT AREA

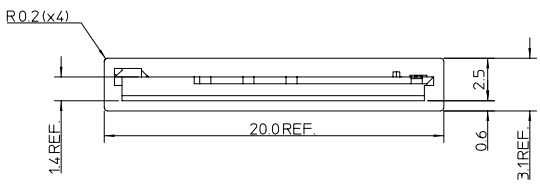
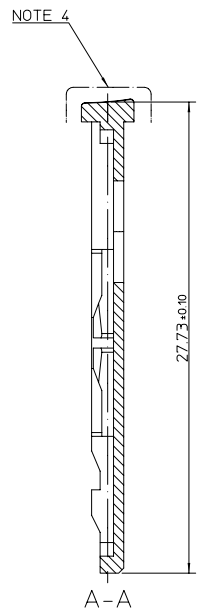
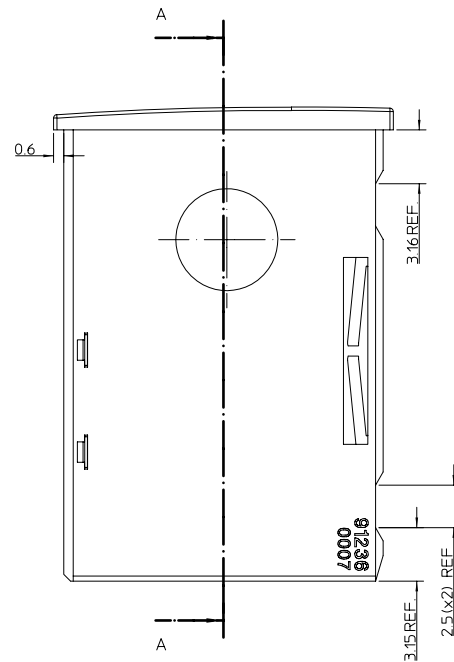
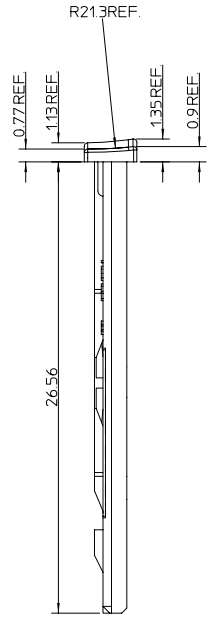
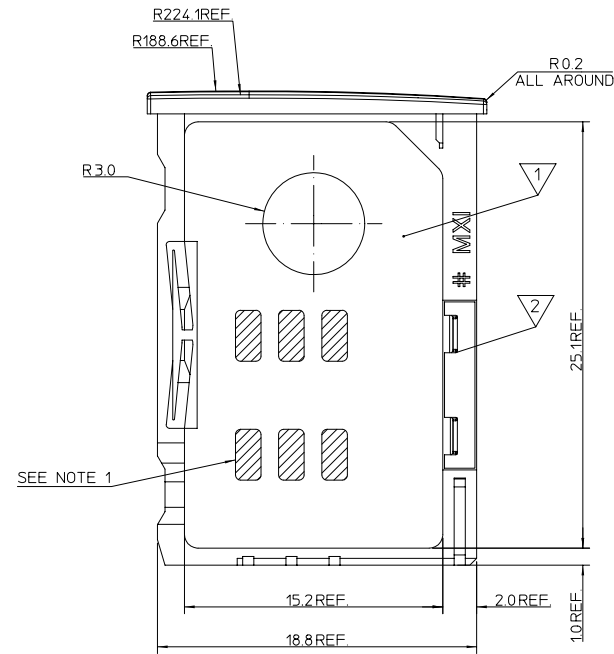

- NOTES:  
 1. POLISHED SURFACE FINISH IN SHADED AREA.  
 2. PACKAGING: LOOSE IN BAG.  
 3. FOR ALL UNSPECIFIED DIMENSIONS AND NOTES SEE SHEET 1.  
 4. MOLDTCH 11010 SURFACE FINISH.

SEE SHEET 1	EC NO: DRWN:FDUGGAN 2001/12/11 CHKD: APPR:	DESCRIPTION	QUALITY SYMBOLS		GENERAL TOLERANCES (UNLESS SPECIFIED)		SCALE 5:1	DESIGN UNITS METRIC	THIRD ANGLE PROJECTION	REVISE ON CAD ONLY	
			▽-0	▽-0	mm	INCH	DIMENSION STYLE MM ONLY		TITLE CARD HOLDER		
					4 PLACES ± ---	± ---	DRAWN BY MINDORAK	DATE 00/05/31	MOLEX INCORPORATED		
					3 PLACES ± ---	± ---	CHECKED BY DHANNON	DATE 00/07/13			
2 PLACES ± 0.05	± ---	ANGULAR ± 2 °		APPROVED BY MWILHITE	DATE 00/07/13	MATERIAL NO. 912360007	DOCUMENT NO. SDA-91236	SHEET NO. 6 OF 6			
DRAFT WHERE APPLICABLE		MUST REMAIN WITHIN DIMENSIONS		THIS DRAWING CONTAINS INFORMATION THAT IS PROPRIETARY TO MOLEX INCORPORATED AND SHOULD NOT BE USED WITHOUT WRITTEN PERMISSION							

J I H G F E D C B A

12 11 10 9 8 7 6 5 4 3 2 1