

DETAILS

Product Number	F14325_JENNY-8X1-CY
Family	Jenny
Type	Lens
Color	clear
Diameter	280 + 35 mm
Height	11,5 mm
Style	rectang
Optic Material	Silicone
Holder Material	
Fastening	glue, pin
Status	production ready
ROHS Compliant	Yes
Date Updated	5/01/2017

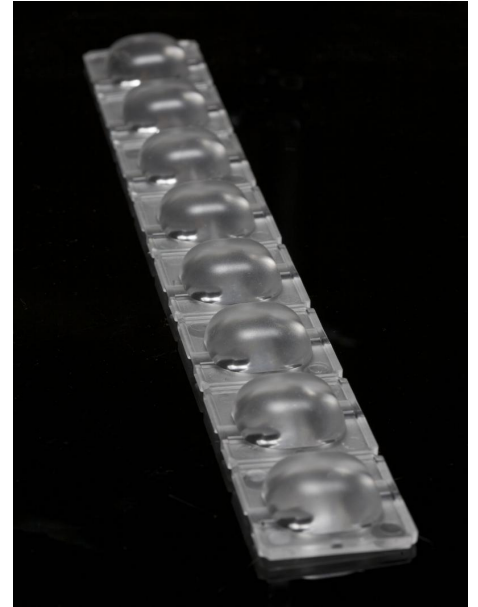

OPTICAL PROPERTIES

LED	Viewing Angle	Light Beam	Efficiency	cd/lm	Connector
V6 Gen6	110+110 deg	Wide-Area...	94 %	0.350	-
V8 Gen6	105+105 deg	Wide-Area...	94 %	0.400	-
V10 Gen6	102+102 deg	Wide-Area...	94 %	0.430	-
V10 Gen7	sim: 97+100	Wide-Area...	sim: 94 %	sim: 0.390	-
CLL01x	104+104 deg	Wide-Area...	94 %	0.440	-
CLL02x/CLU02x (LES10)	103+103 deg	Wide-Area...	93 %	0.400	-
CLU700/701	102+102 deg	Wide-Area...	93 %	0.470	-
CXA/B 15xx	106+106 deg	Wide-Area...	94 %	0.380	-
MK-R	105+105 deg	Wide-Area...	92 %	0.420	-
CXA/B 13xx	105+105 deg	Wide-Area...	94 %	0.410	-
XM-L EZW	103+103 deg	Wide-Area...	94 %	0.460	-
MX-6	sim: 102+102	Wide-Area...	sim: 93 %	-	-
XHP50	105+105 deg	Wide-Area...	94 %	0.420	-
LUXEON M/MX	104+104 deg	Wide-Area...	94 %	0.450	-
LUXEON 5258	103+103 deg	Wide-Area...	94 %	0.490	-
NSMx286M	105+105 deg	Wide-Area...	94 %	0.410	-
Solerialq P6	107+107 deg	Wide-Area...	94 %	0.400	-
Solerialq P9	106+106 deg	Wide-Area...	94 %	0.390	-
Duris S8	102+102 deg	Wide-Area...	94 %	0.520	-
Duris S10	108+108 deg	Wide-Area...	94 %	0.350	-
Duris P10	sim: 100	Wide-Area...	sim: 93 %	sim: 0.535	-
Solerialq S9	sim: 104+104	Wide-Area...	sim: 94 %	sim: 0.410	-
COB D Series LES 9.8 mm	106+106 deg	Wide-Area...	94 %	0.370	-
MJT COB LES 9.8	105+105 deg	Wide-Area...	93 %	0.360	-
MJT COB LES 6	111+111 deg	Wide-Area...	91 %	0.360	-



PRODUCT DATASHEET

Jenny series

last update 5/1/2017

OPTICAL PROPERTIES

LED	Viewing Angle	Light Beam	Efficiency	cd/lm	Connector
Mini Zenigata (GW6BM)	sim: 105+105	Wide-Area...	sim: 93 %	-	-
SLE G5 LES6	108+108 deg	Wide-Area...	93 %	0.400	-
SLE G5 LES11	106+106 deg	Wide-Area...	91 %	0.350	-

Relative intensity of F14531_JENNY-CY_(Duris_S10)

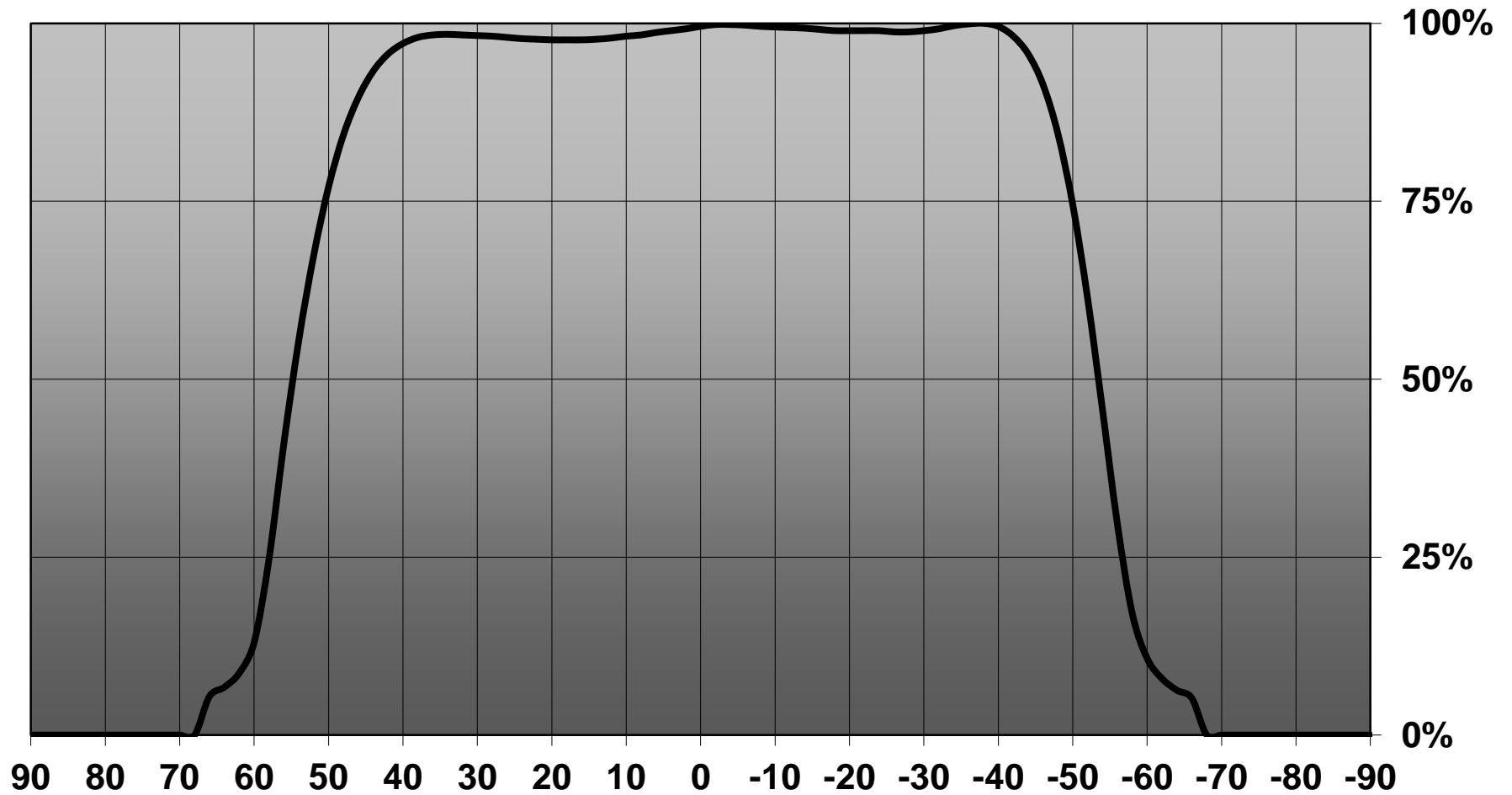

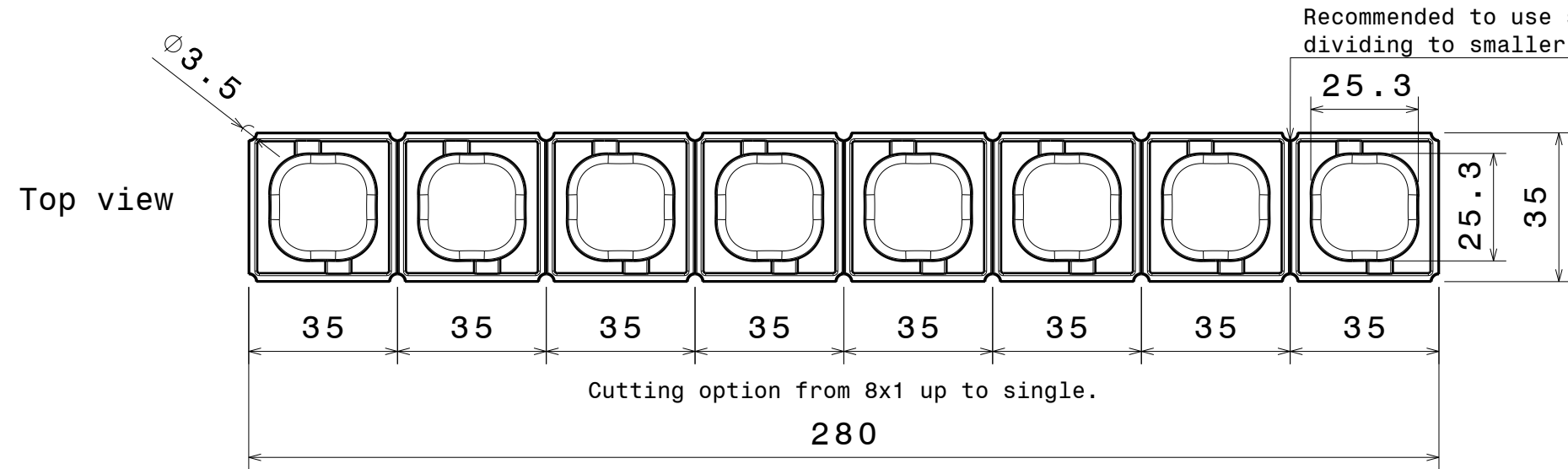
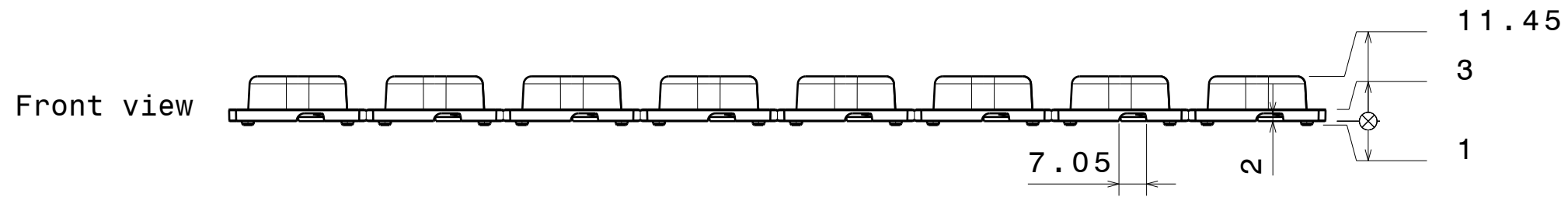
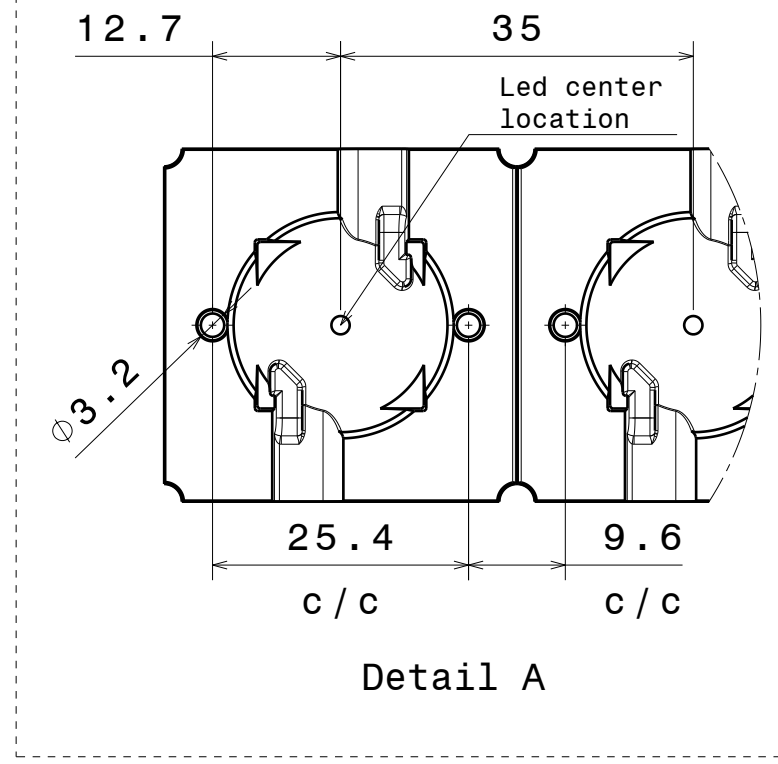
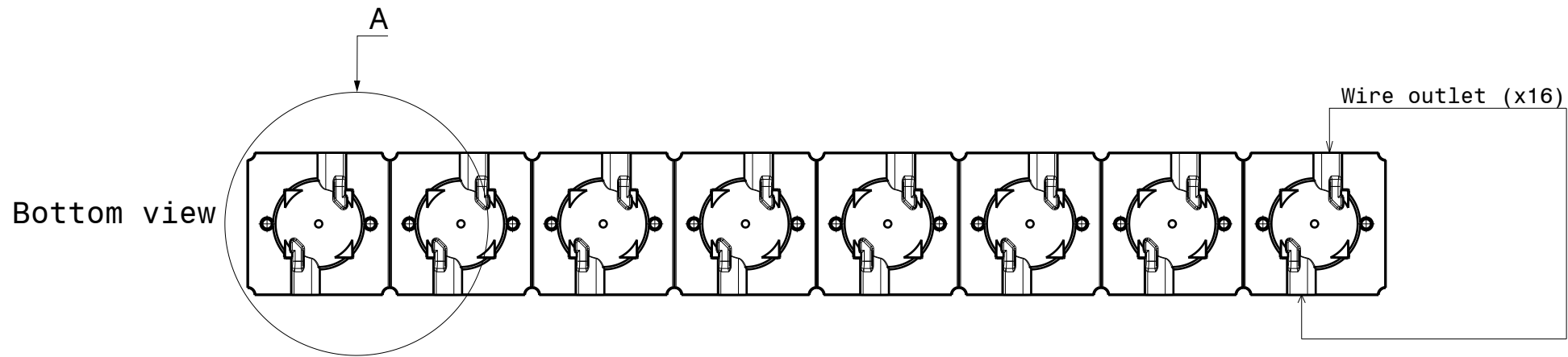

Recommended to use scissors when dividing to smaller units.

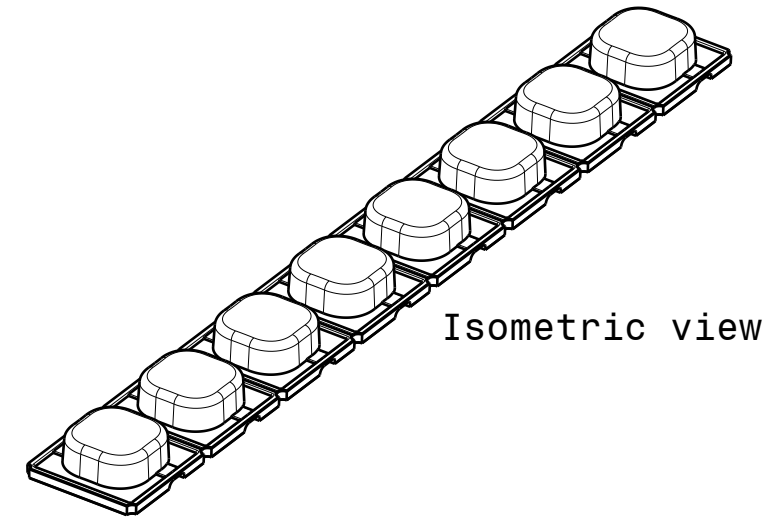

When thermal adhesive tape is used, recommended tape thickness up to 0.3mm. When assembling led ensure correct position in relation to lens position pin hole.

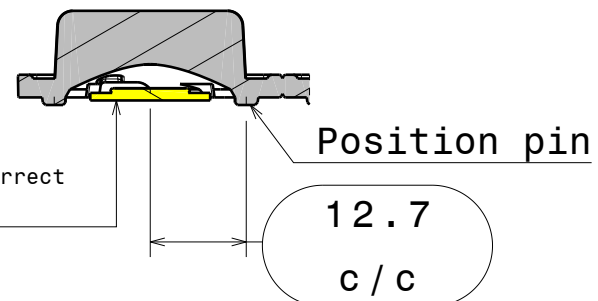

Section view B-B
Scale: 1:1

INDEX	PART NO	DESCRIPTION	MATERIAL	COLOUR
1	F14325	JENNY-8X1-CY	Optical grade silicon	

Tolerances if not otherwise shown
According to DIN ISO 2768-1
Linear measures: class V
Please note that due to the elasticity of products made of silicone actual measured values may vary, and therefore typical tolerance values may not be applied.

LEDiL LediL Oy
Salorankatu 10
FIN 24240 SALO
Finland

THIRD ANGLE PROJECTION:

DRAWING TITLE
F14325_JENNY-8X1-CY

This drawing is the property of LEDiL Oy. It may not be reproduced, copied or communicated without a written agreement with LEDiL Oy.

SIZE	PART NUMBER
A3	F14325

SCALE	1:1	WEIGHT		SHEET	1/1
-------	-----	--------	--	-------	-----

Luminaire: LEDiL Oy F14325_JENNY-8X1-CY_(V6)
Lamps: 1 x BRIDGELUX_V6_3500lm@250mA_P=40W_I=249.9mA

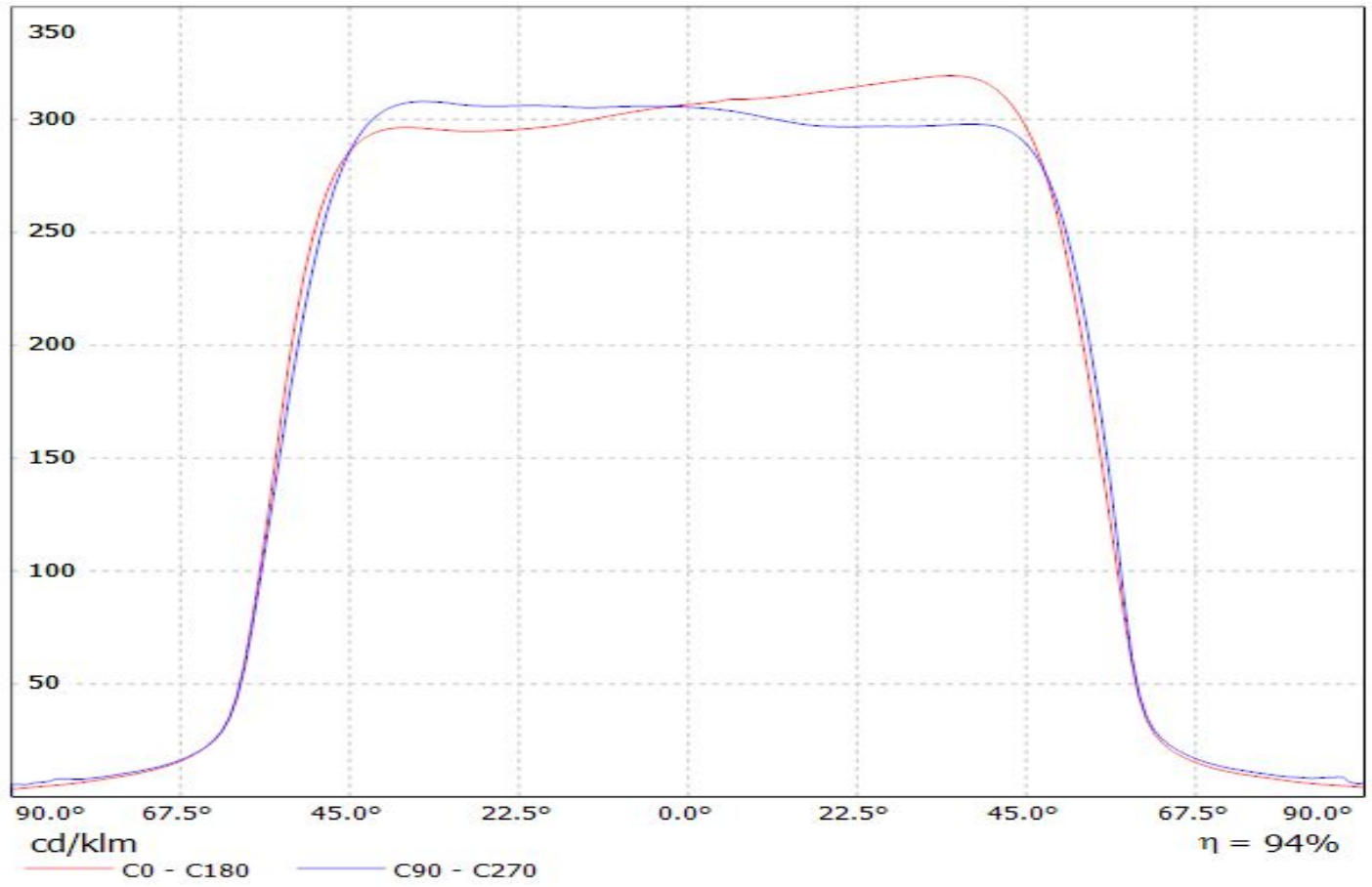

Luminaire: LEDiL Oy F14325_JENNY-8X1-CY
Lamps: 1 x BRIDGELUX_V8_6900lm@250mA_P=70W_I=249.8mA

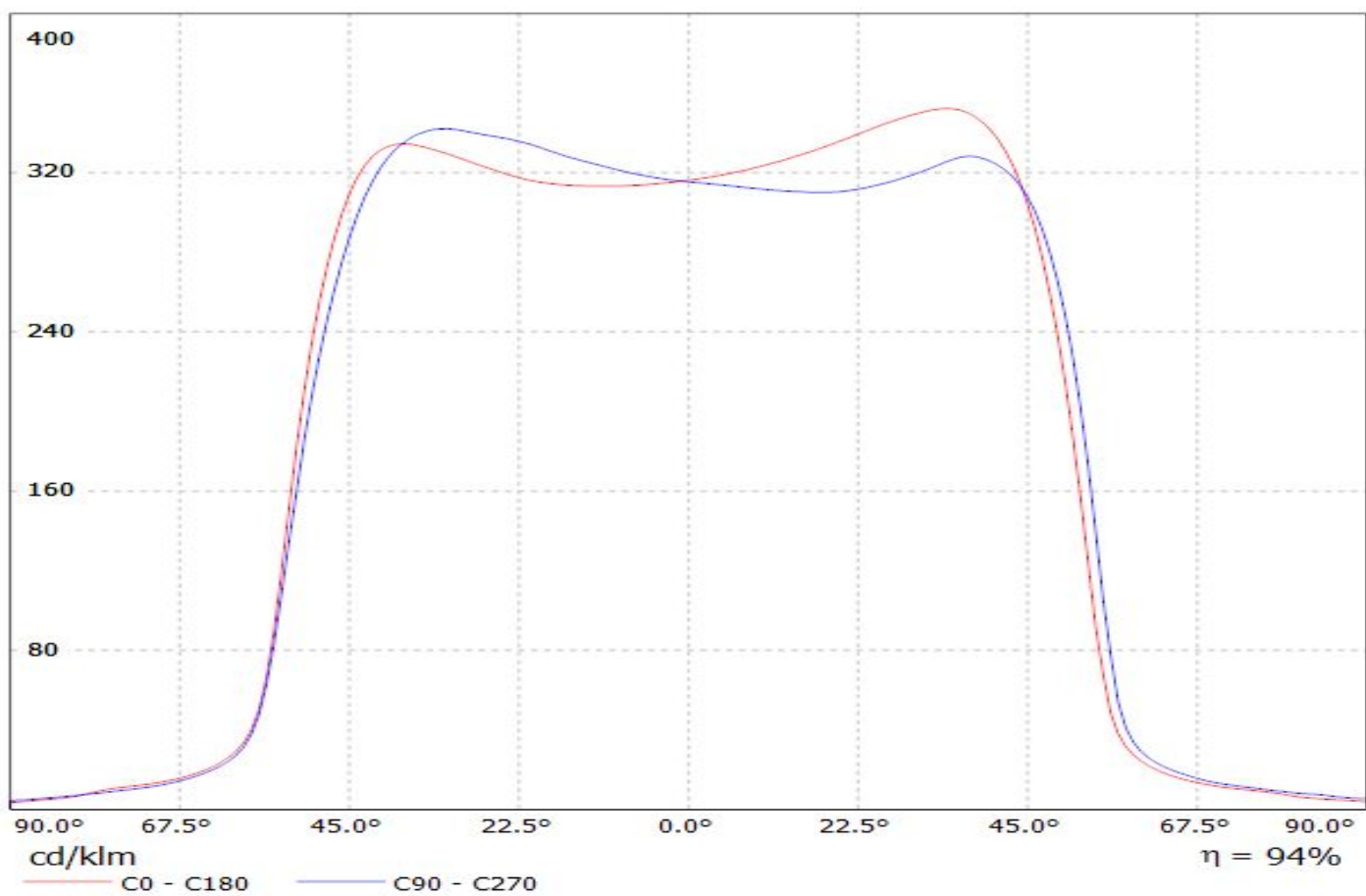

Luminaire: LEDiL Oy F14325_JENNY-8X1-CY_(V10)

Lamps: 1 x BRIDGELUX_V10_(BXRE-30E1000B-X2)_6100lm@250mA_P=50W_I=249.9mA

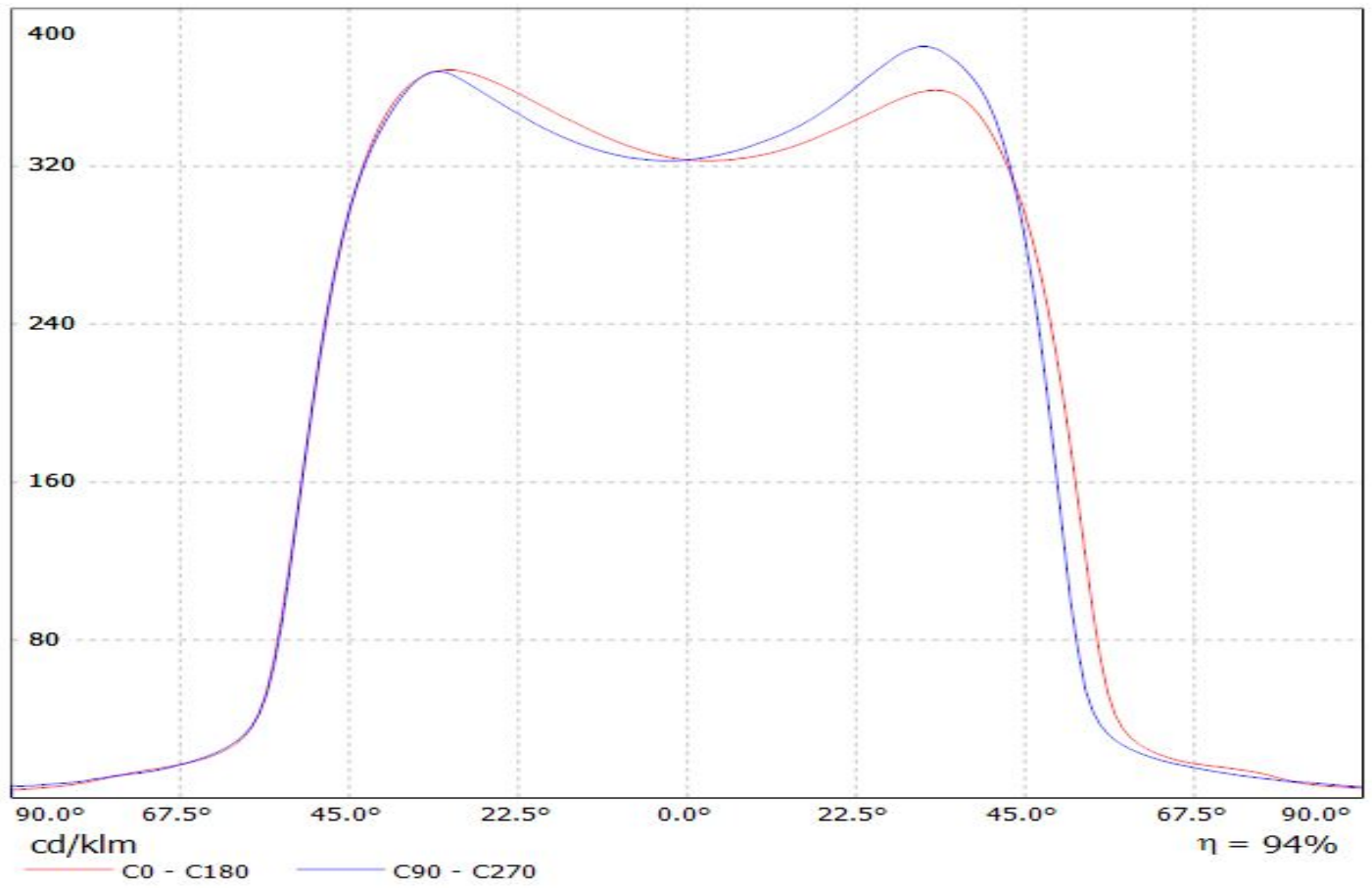

Luminaire: Ledil Oy F14325_JENNY-8X1-CY_BRIDGELUX_V10_Gen7_SIMULATED
Lamps: 1 x BRIDGELUX V10 Gen7

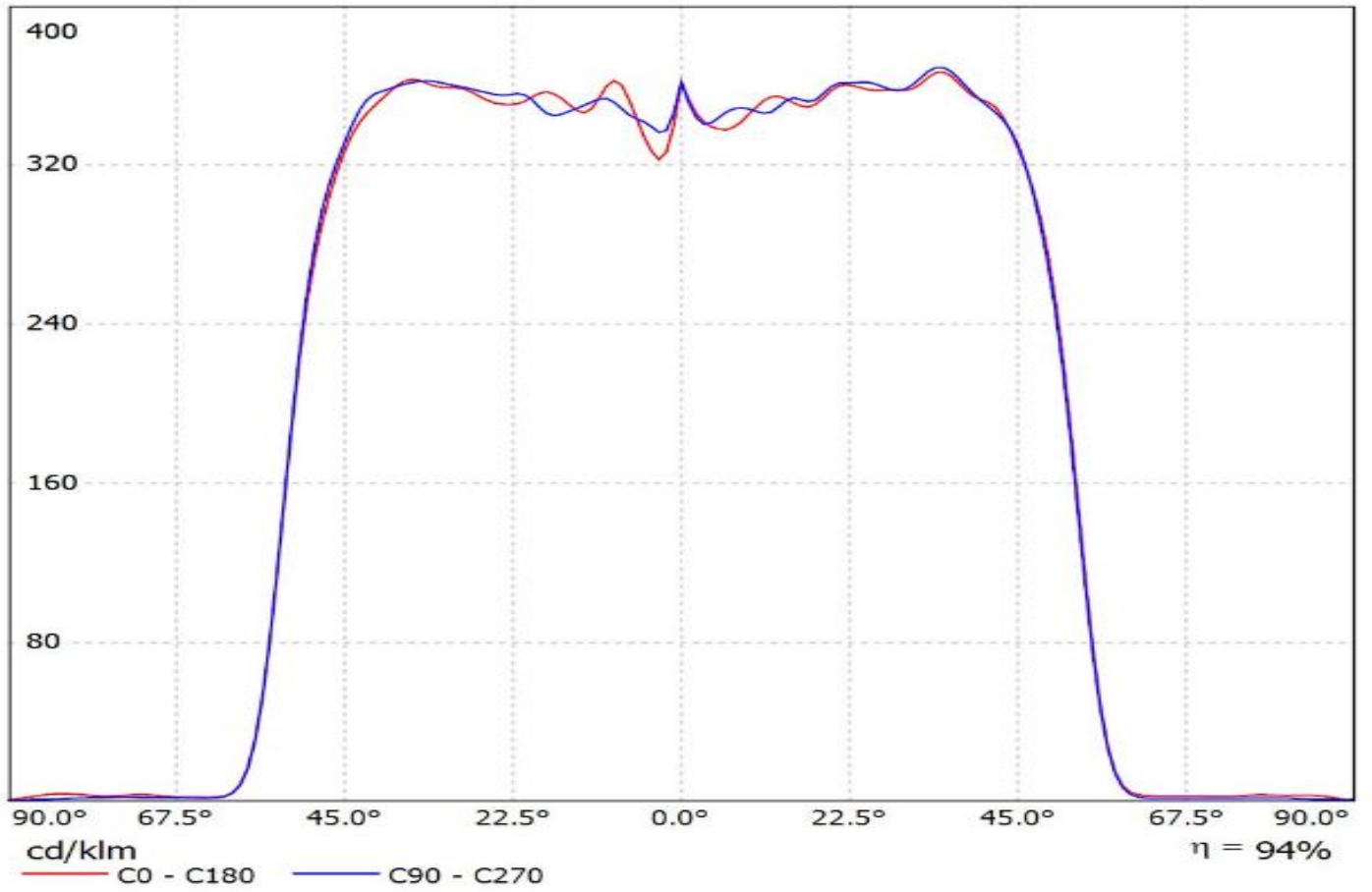

Luminaire: LEDiL Oy F14531_JENNY-CY_(CLL010)

Lamps: 1 x CITIZEN_CLL010_x8_(CLL010-0305A1-303M1A2)_1658.8lm@250mA_P=18W_I=249.9mA

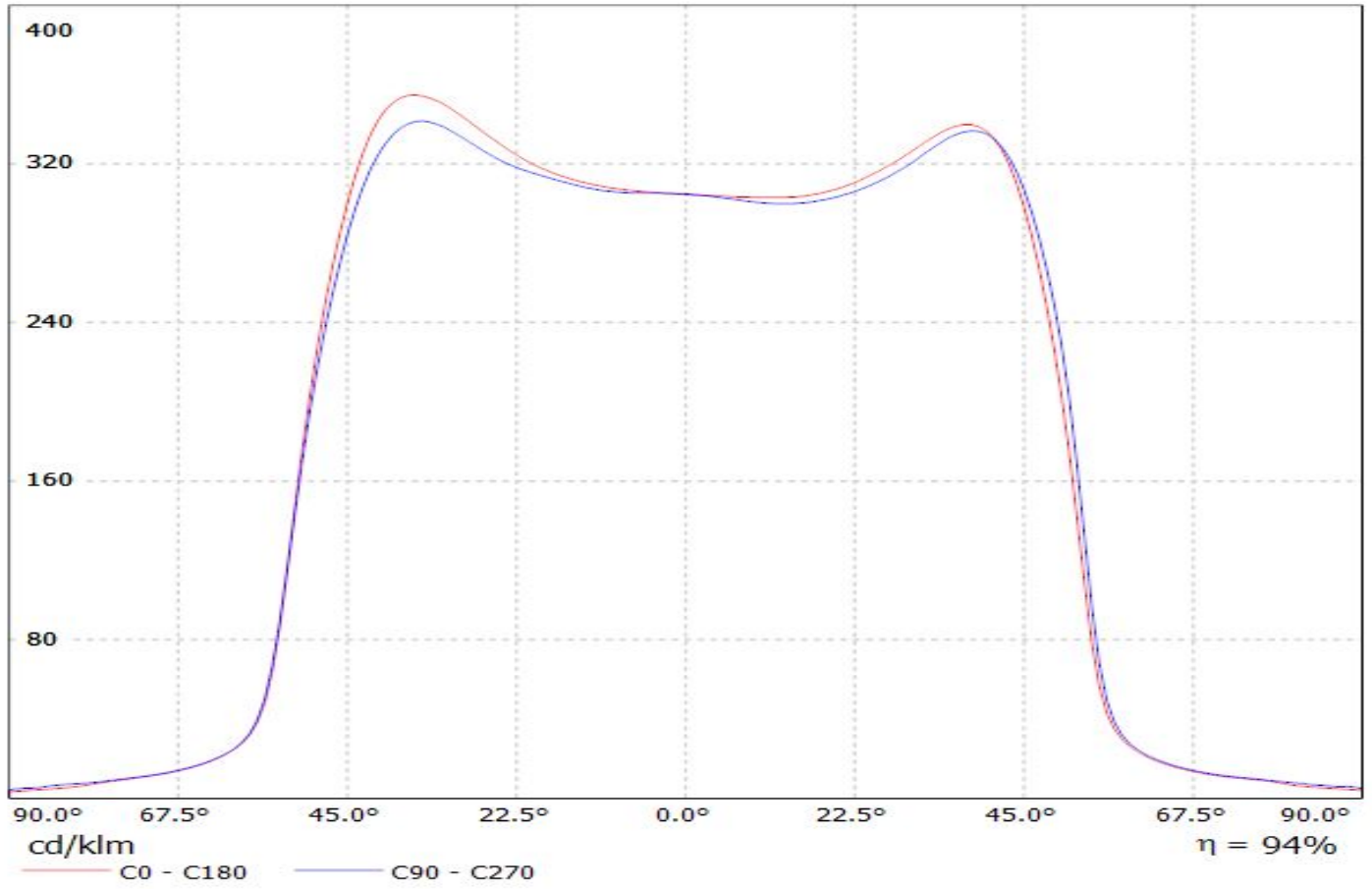

Luminaire: LEDiL Oy F14325_JENNY-8X1-CY_(CLL022)

Lamps: 1 x CITIZEN_CLL022_x8_(CLL022-1204A5-030H7E1)_5900lm@250mA_P=69W_I=249.8mA

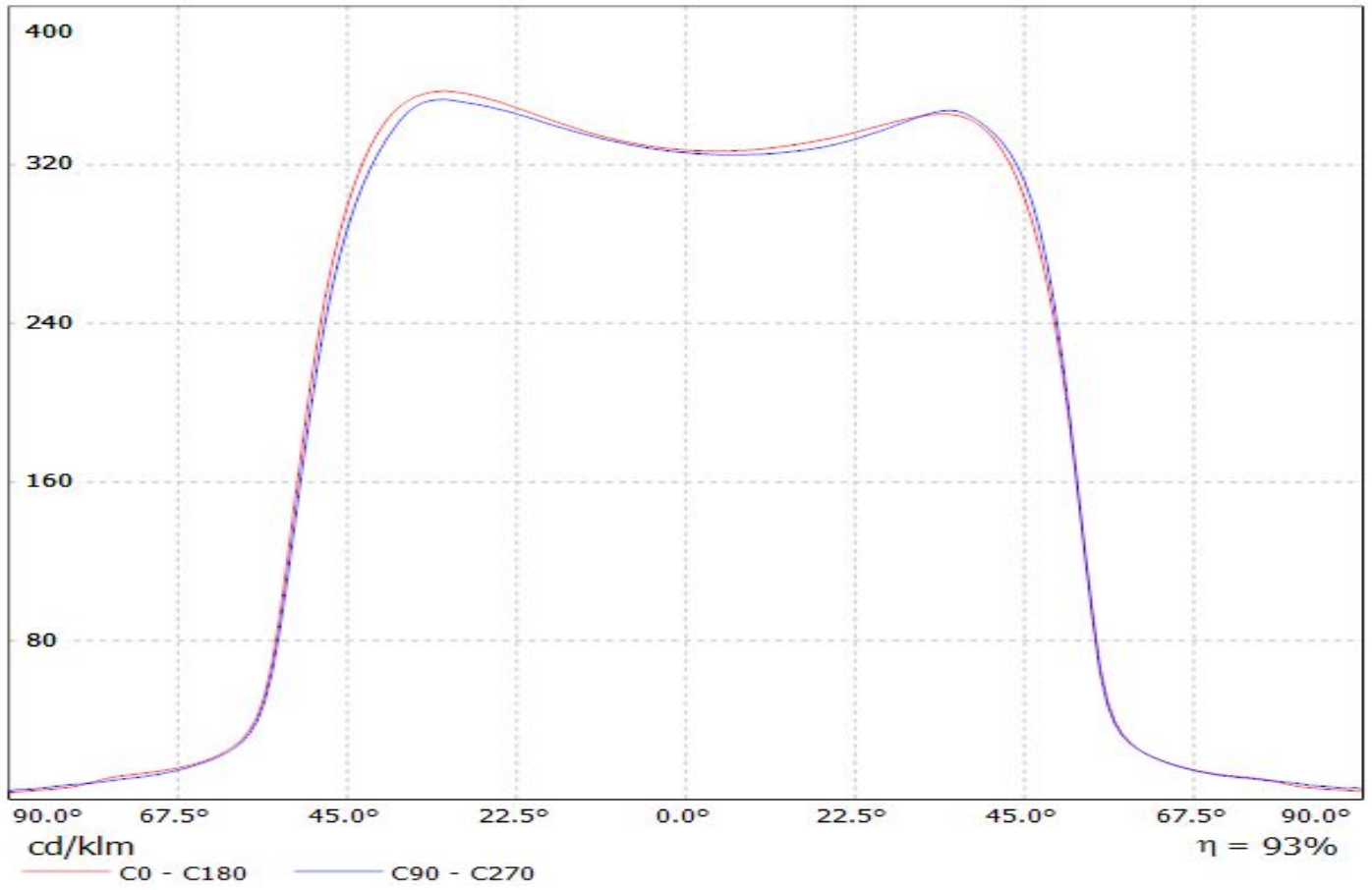

Luminaire: Ledil F14325_JENNY-8X1-CY_(CLU700)
Lamps: 1 x Citizen_CLU700_394.637lm@100mA_P=2.8W_I=0.10A

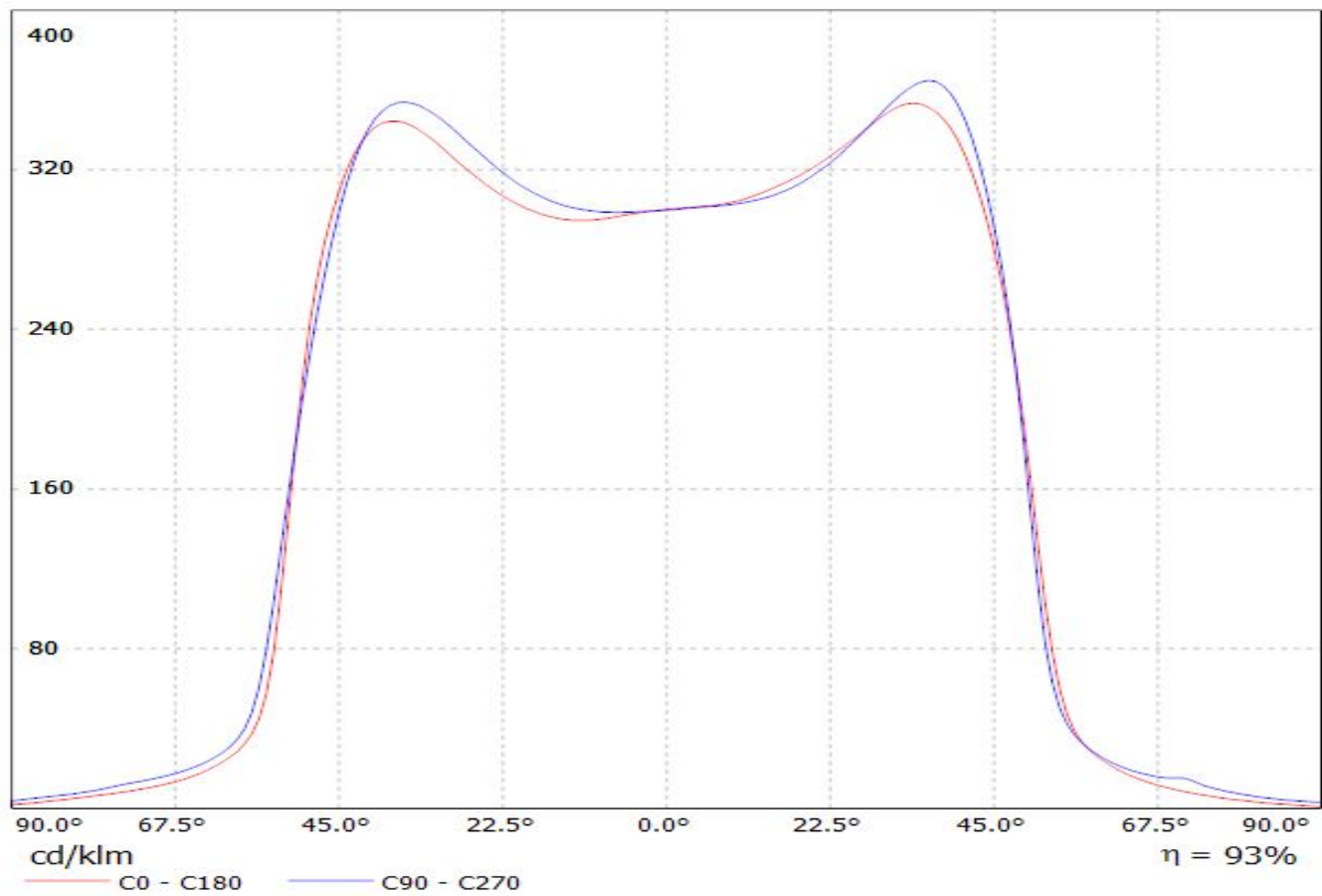

Luminaire: LEDiL Oy F14325_JENNY-8X1-CY_(CXA1520)

Lamps: 1 x CREE_CXA1520_(CXA1520-30F-N4-N0H-0001)_976.326lm@250mA_U=8.36855W_I=249.8mA

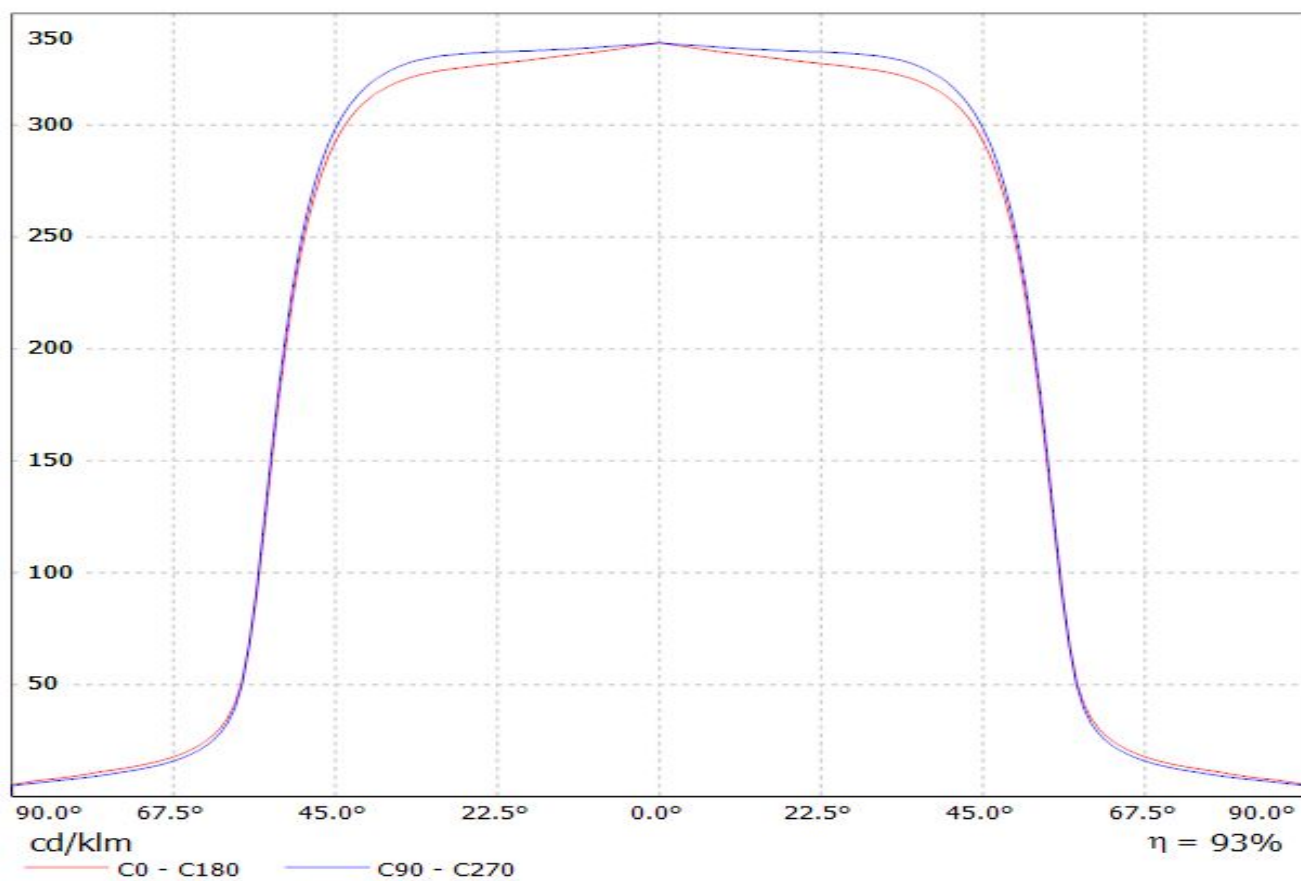

Luminaire: LEDiL Oy F14325_JENNY-8X1-CY_(MK-R)
Lamps: 1 x MK-R_2820lm@250mA_CCT=3276K_P=22W_I=249.9mA

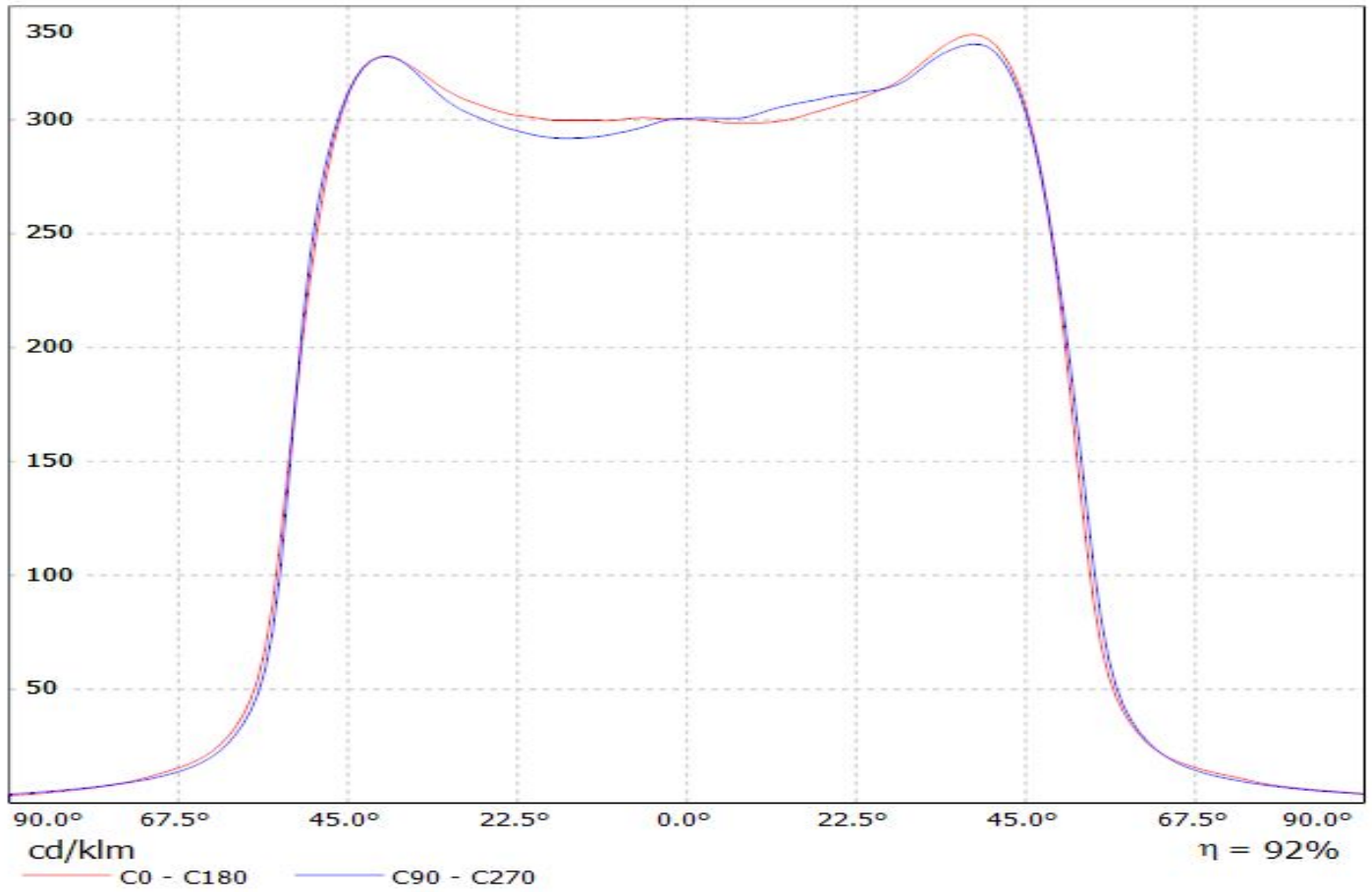

Luminaire: LEDiL Oy F14325_JENNY-8X1-CY_(CXA1310)
Lamps: 1 x CREE_CXA1310_(CXA1310-30H-G4-F0Y-00001)
_2900lm@250mA_CCT=3000K_P=34W_I=249.8mA

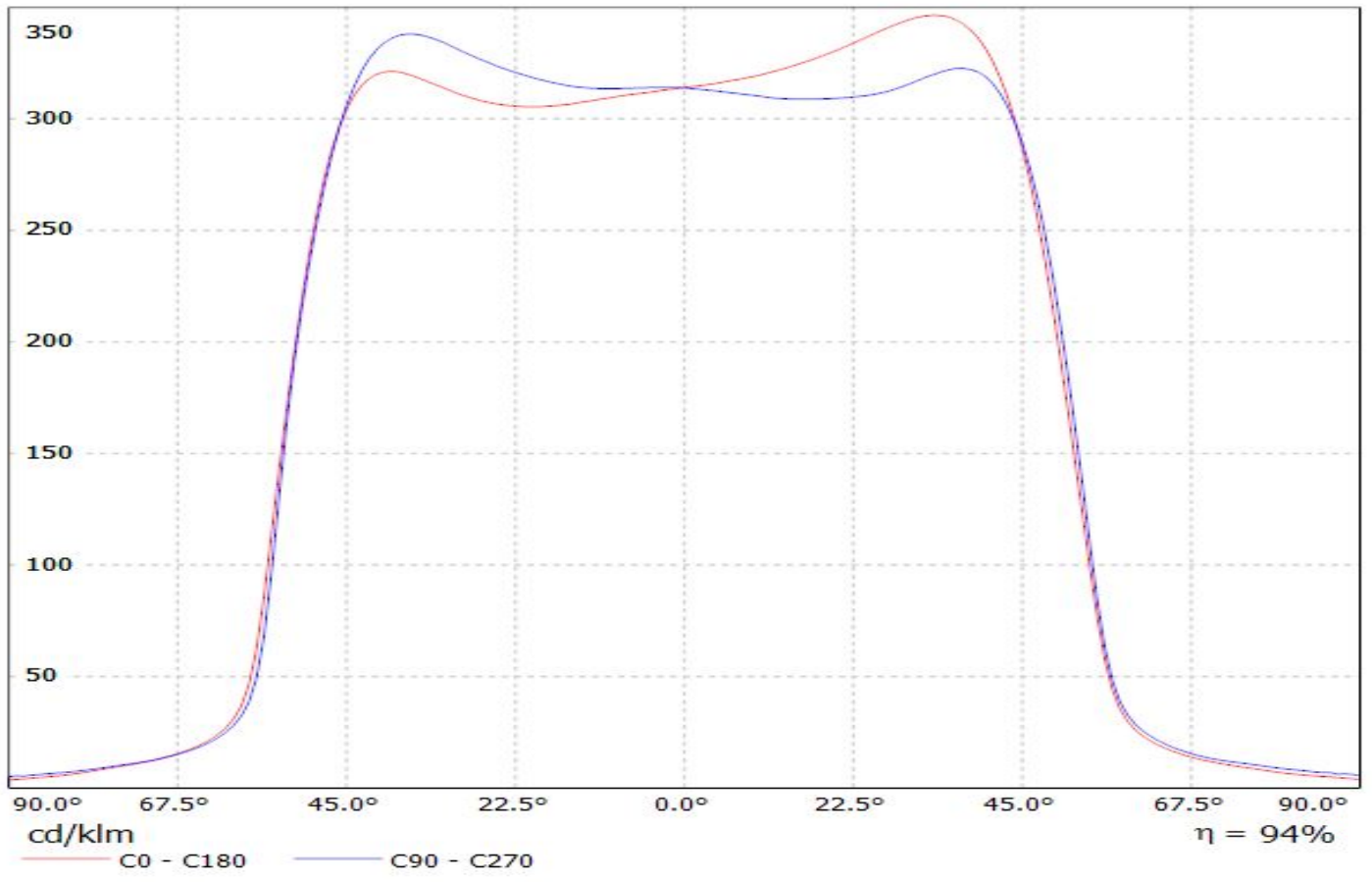

Luminaire: LEDiL Oy F14325_JENNY-8X1-CY_(XM-L)
Lamps: 1 x CREE_XM-L_EZW_1040lm@250mA_P=12W_I=249.9mA

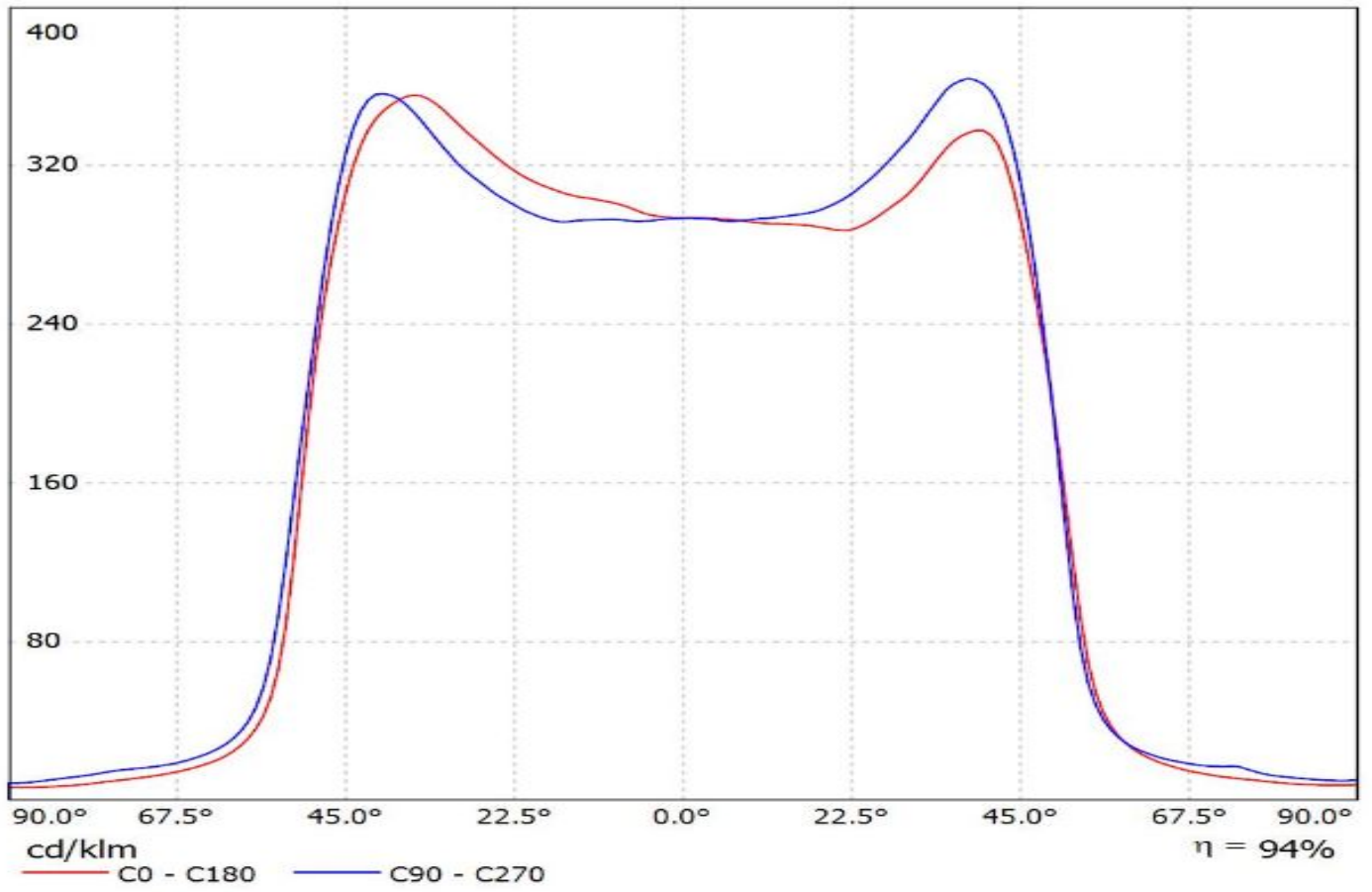

Ledil F14325_JENNY-8X1-CY_(XPH50) / LDC (Linear)

Luminaire: Ledil F14325_JENNY-8X1-CY_(XPH50)

Lamps: 1 x XHP50_warm_white_1686.8lm@250mA_P=11.2166W_I=0.25A

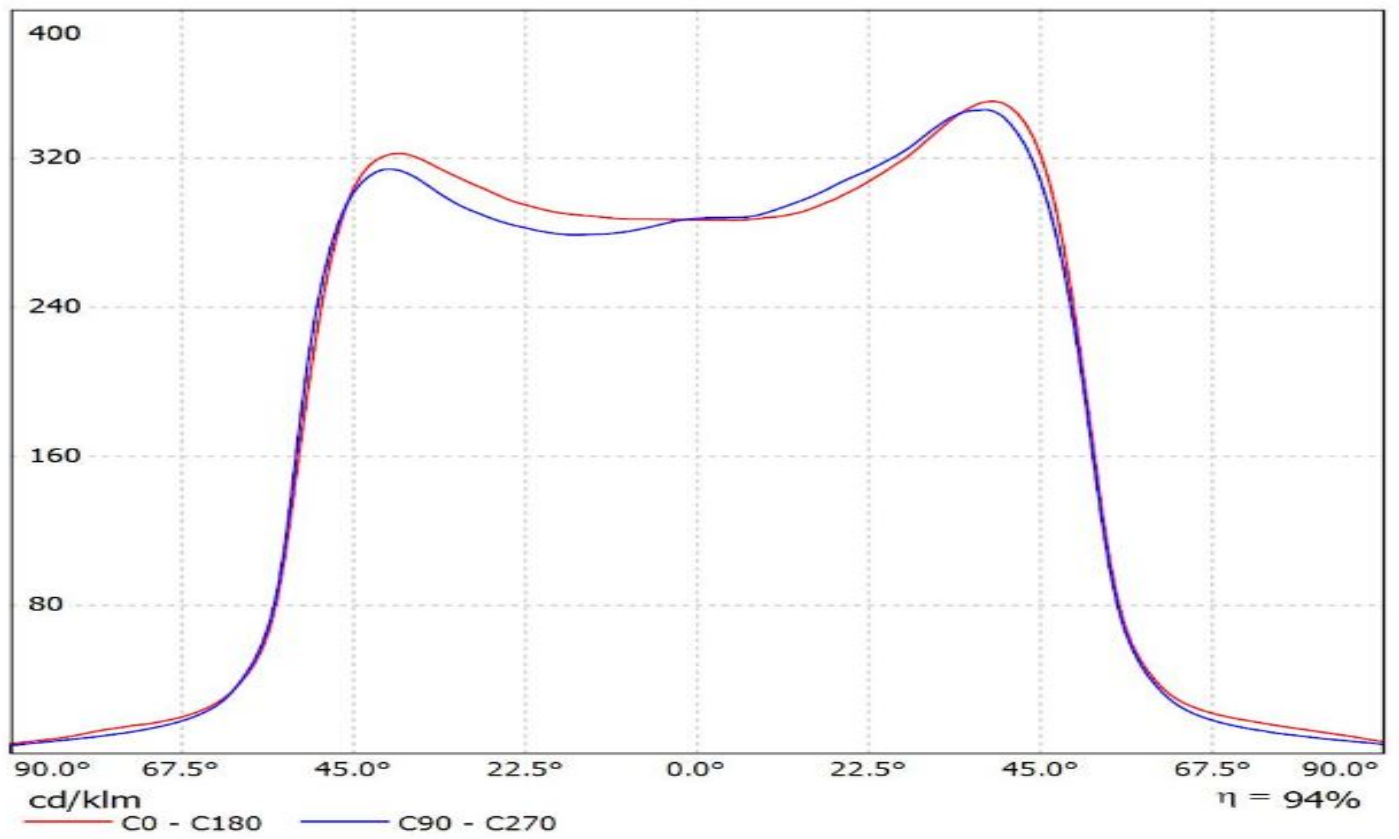

Luminaire: LEDiL Oy F14325_JENNY-8X1-CY_(LUXEON_M)
Lamps: 1 x LUXEON_M_(LXR7-SW40)_2540lm@250mA_P=21W_I=249.8mA

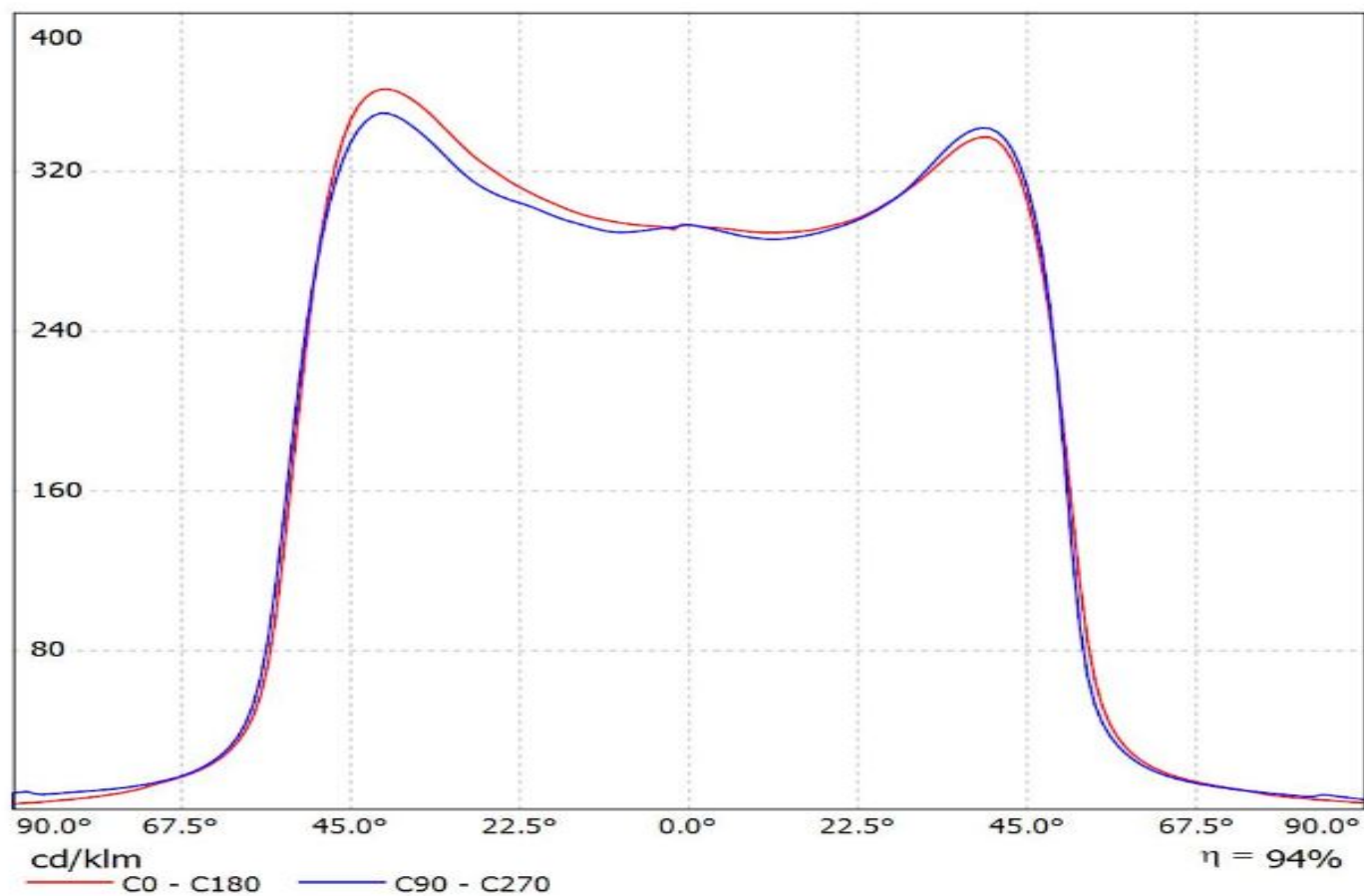

Ledil F14325_JENNY-8X1-CY_(LUXEON_5258) / LDC (Linear)

Luminaire: Ledil F14325_JENNY-8X1-CY_(LUXEON_5258)

Lamps: 1 x LUXEON_5258_(24VOLTS)_2460.584lm@800mA_CCT=2700K_P=18.592W_I=0.8A

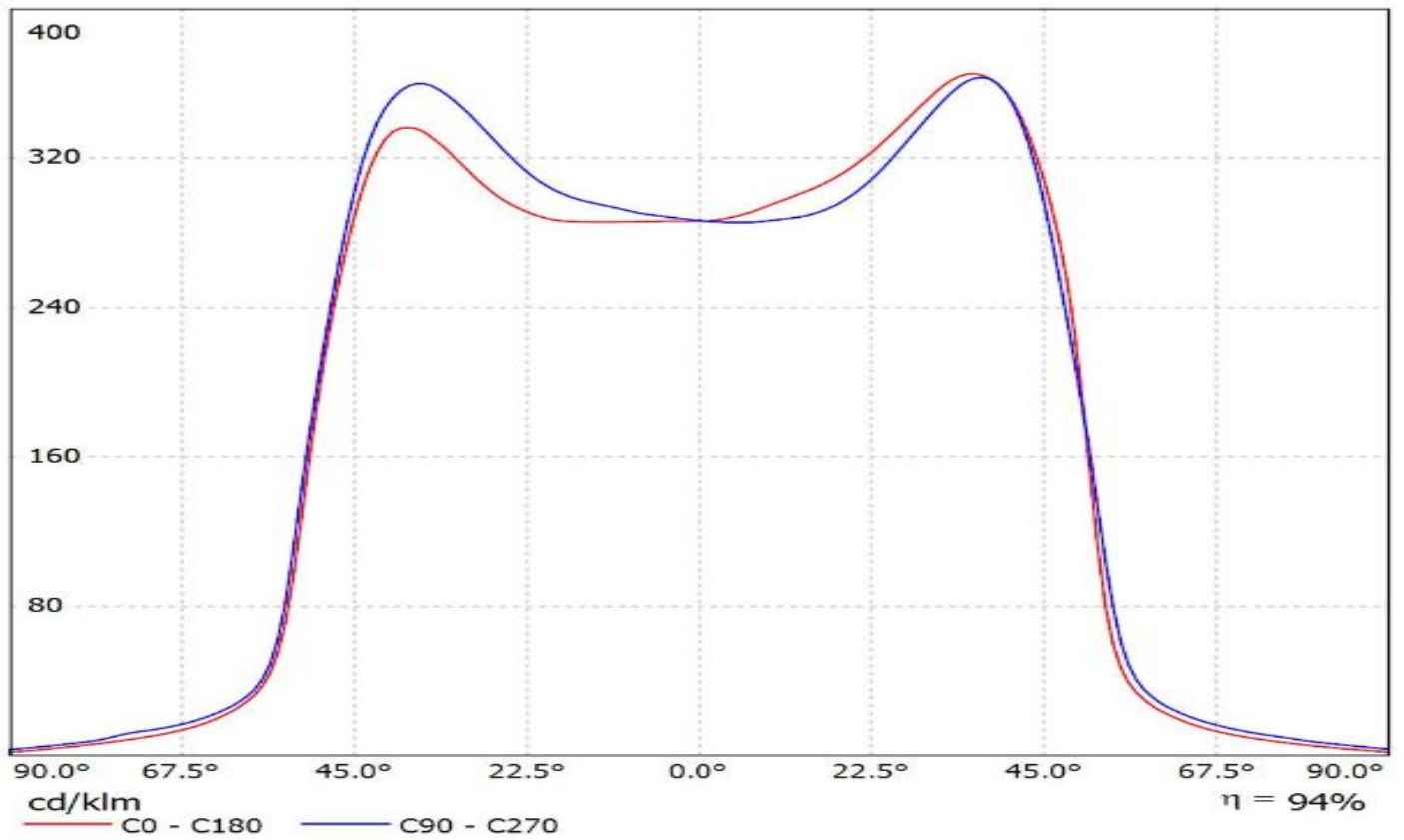

Luminaire: LEDiL Oy F14325_JENNY-8X1-CY_(NSMx286M)

Lamps: 1 x NICHIA_NSMx286M_(NSML286ME)_2680lm@100mA_P=27W_I=100.1mA

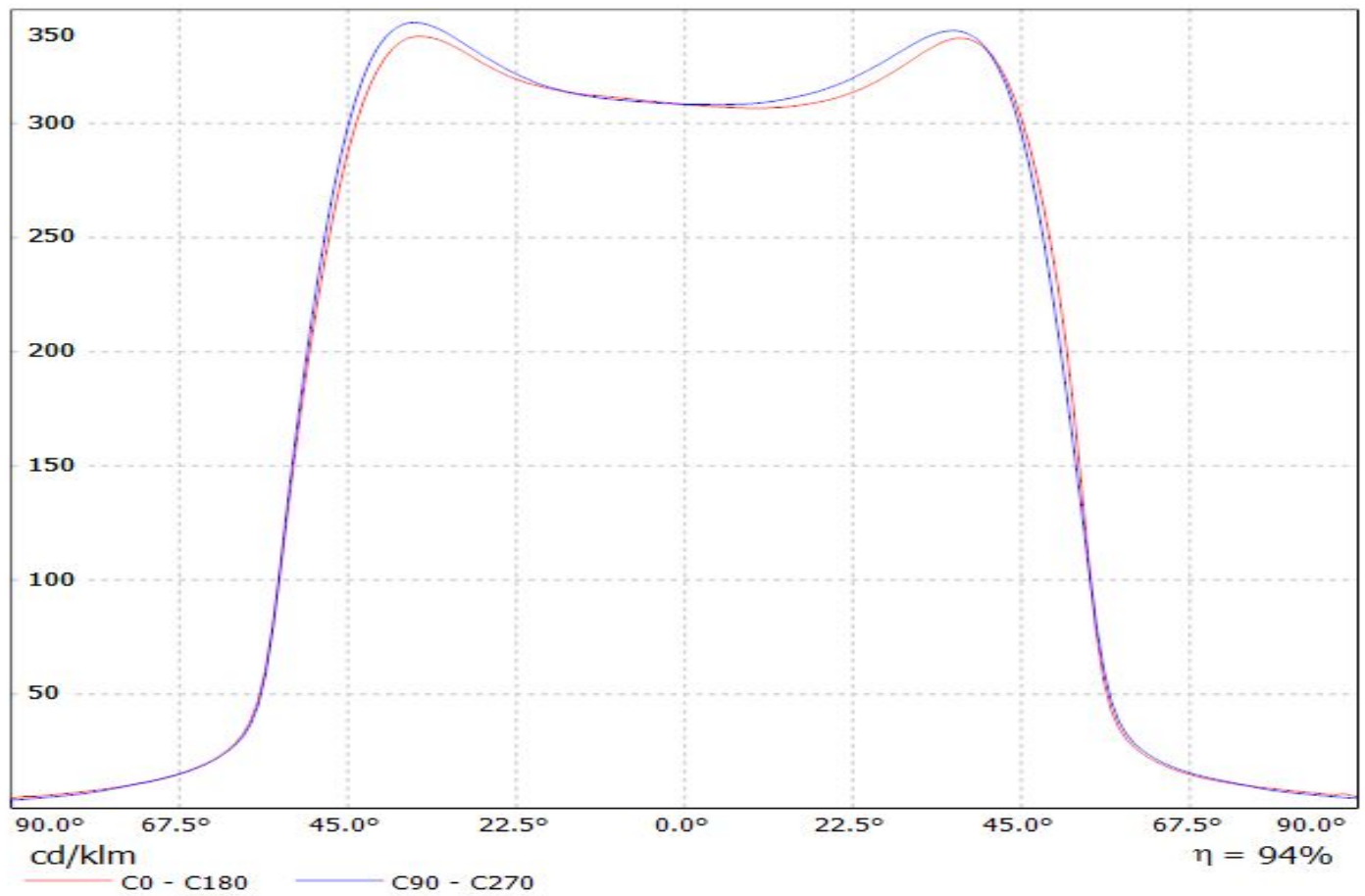

Luminaire: LEDiL Oy F14325_JENNY-8X1-CY_(P6)

Lamps: 1 x OSRAM_SOLERIQ_P6_(GW_MAFJB1.EM)_5550lm@250mA_P=48W_I=249.9mA

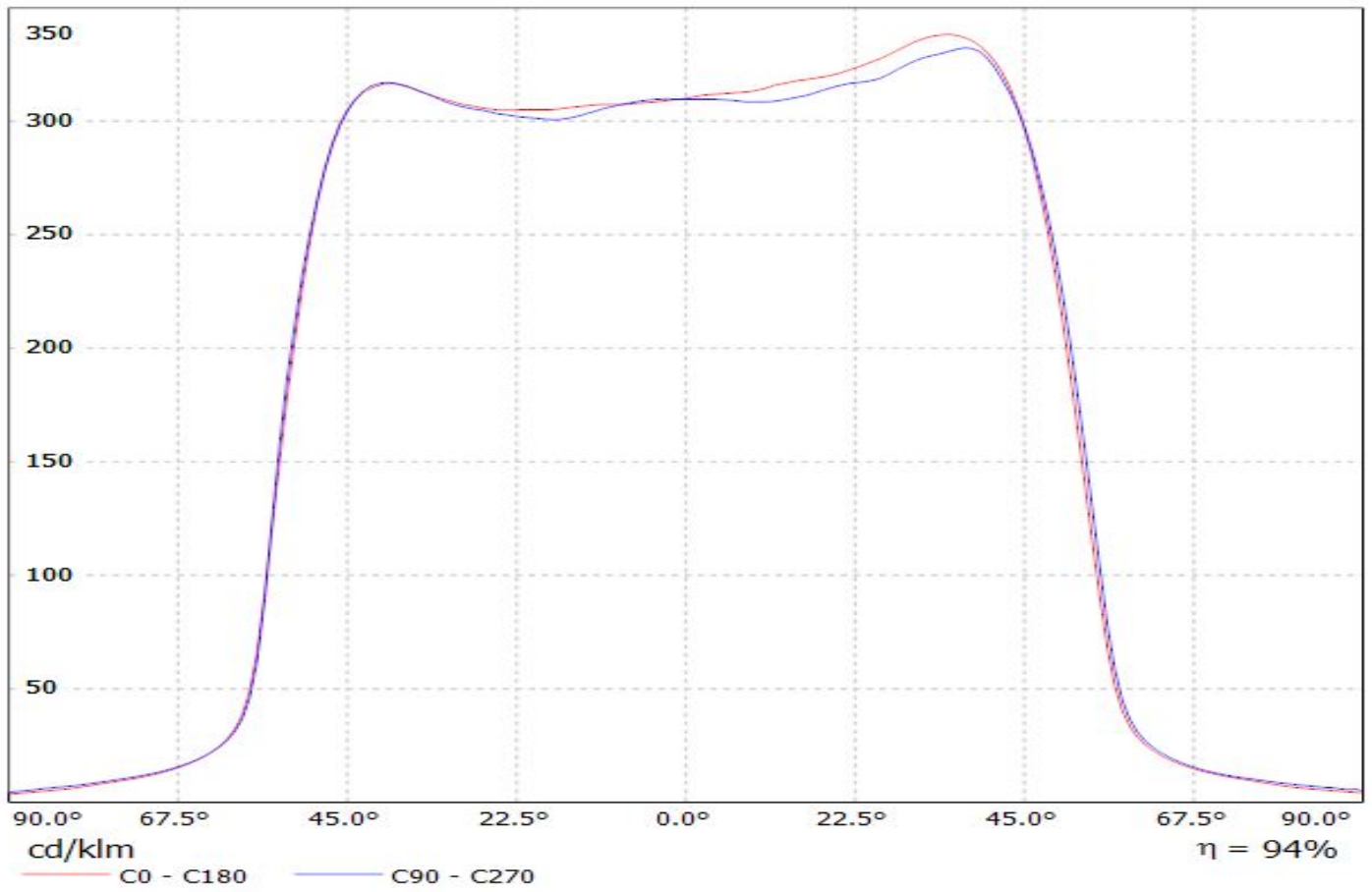

Luminaire: LEDiL Oy F14325_JENNY-8X1-CY_(P9)

Lamps: 1 x OSRAM_SOLERIQ_P9_(GW_MAFJB1.EM)_7200lm@250mA_P=55W_I=249.8mA

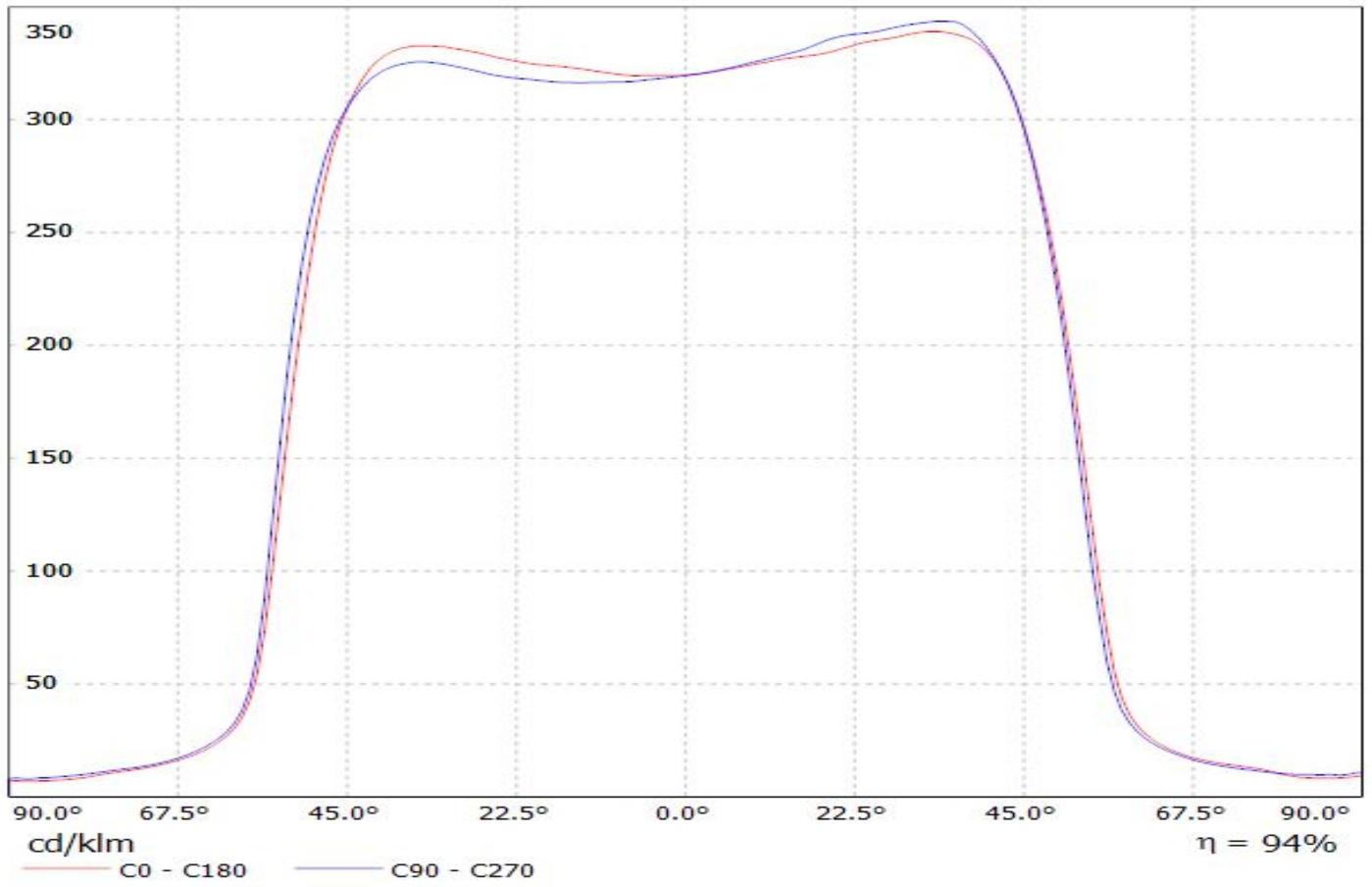

Ledil F14326_JENNY-8X1-T4_(Duris_S8) / LDC (Linear)

Luminaire: Ledil F14326_JENNY-8X1-T4_(Duris_S8)

Lamps: 1 x Osram_Duris_S8_(GW_P9LMS1.EC)_1611.928lm@800mA_CCT=2857K_P=14.4W_I=0.8A

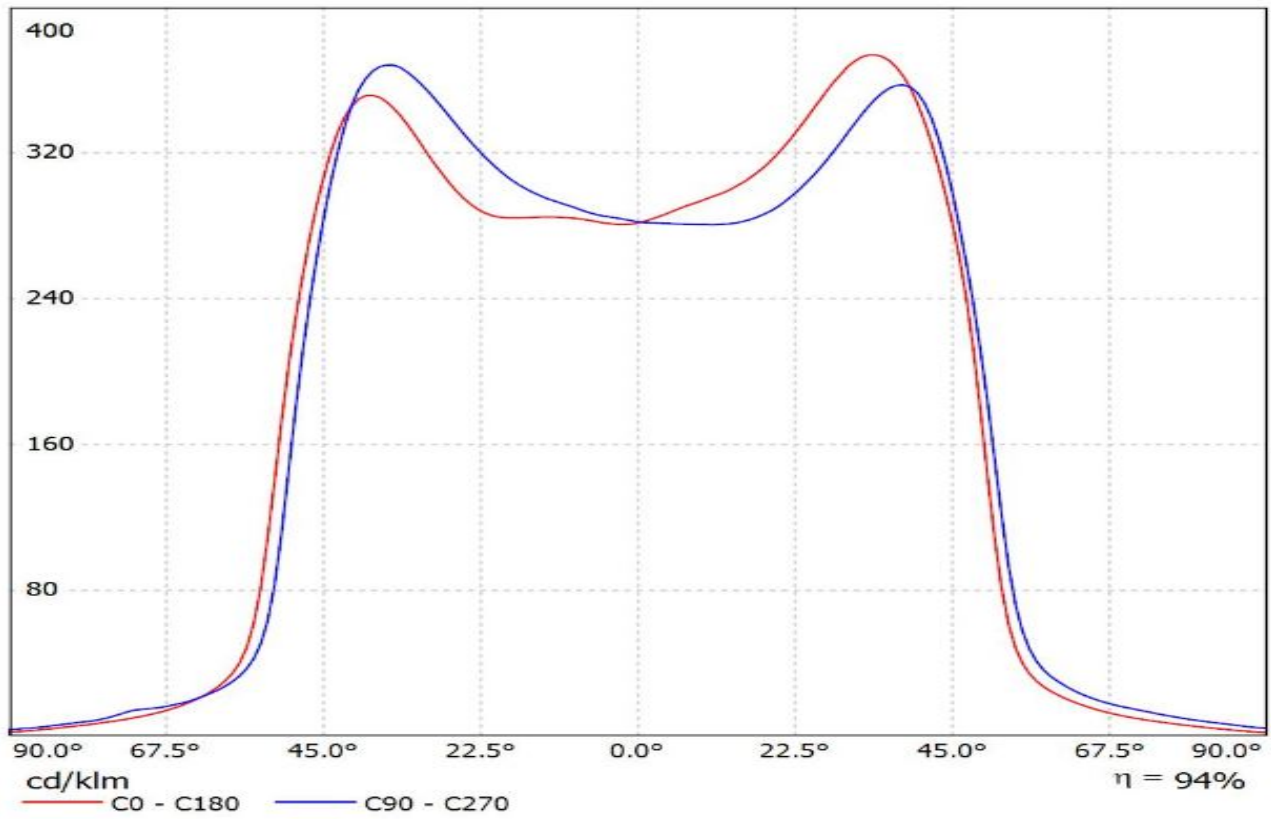

Luminaire: Ledil Oy F14325_JENNY-8X1-CY_(Soleriq_S9)_SIMULATED
Lamps: 1 x Osram Soleriq S9 (GW KAFJB3.EM)

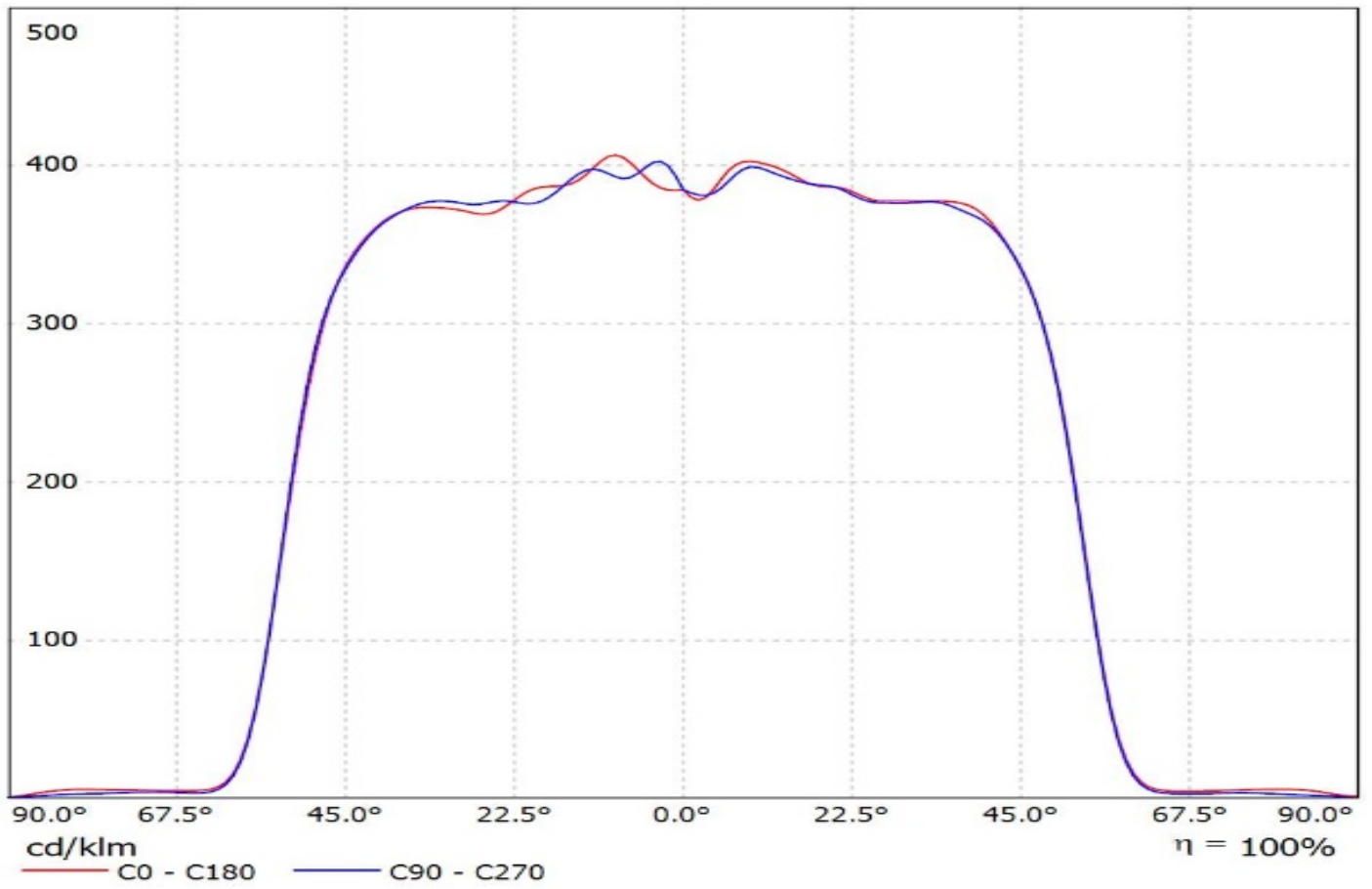

Luminaire: LEDiL Oy FCN14648_JENNY-CY (COB_D_LES_9.8mm)

Lamps: 1 x Samsung_COB_D_series_LES_9.8mm_LC013D_534.999lm@100mA_P=3.1948W_I=0.100A (x8)

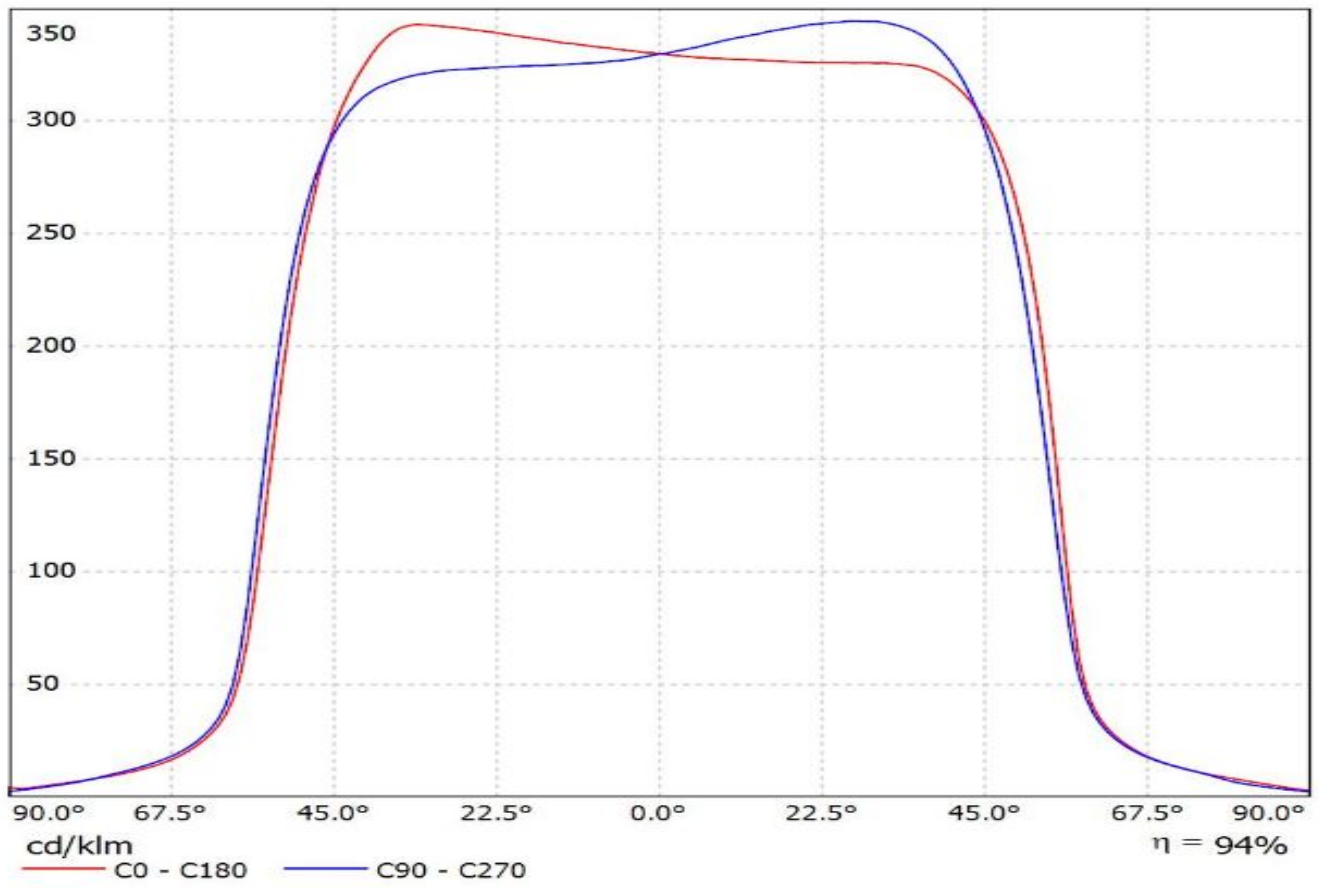

Luminaire: Ledil F14325_JENNY-8X1-CY_(MJT_12W_Les9,8)

Lamps: 1 x Seoul_MJT_12W_Les9.8mm_(SAWx1063A)_1245.58lm@250mA_P=8.30025W_I=0.25A

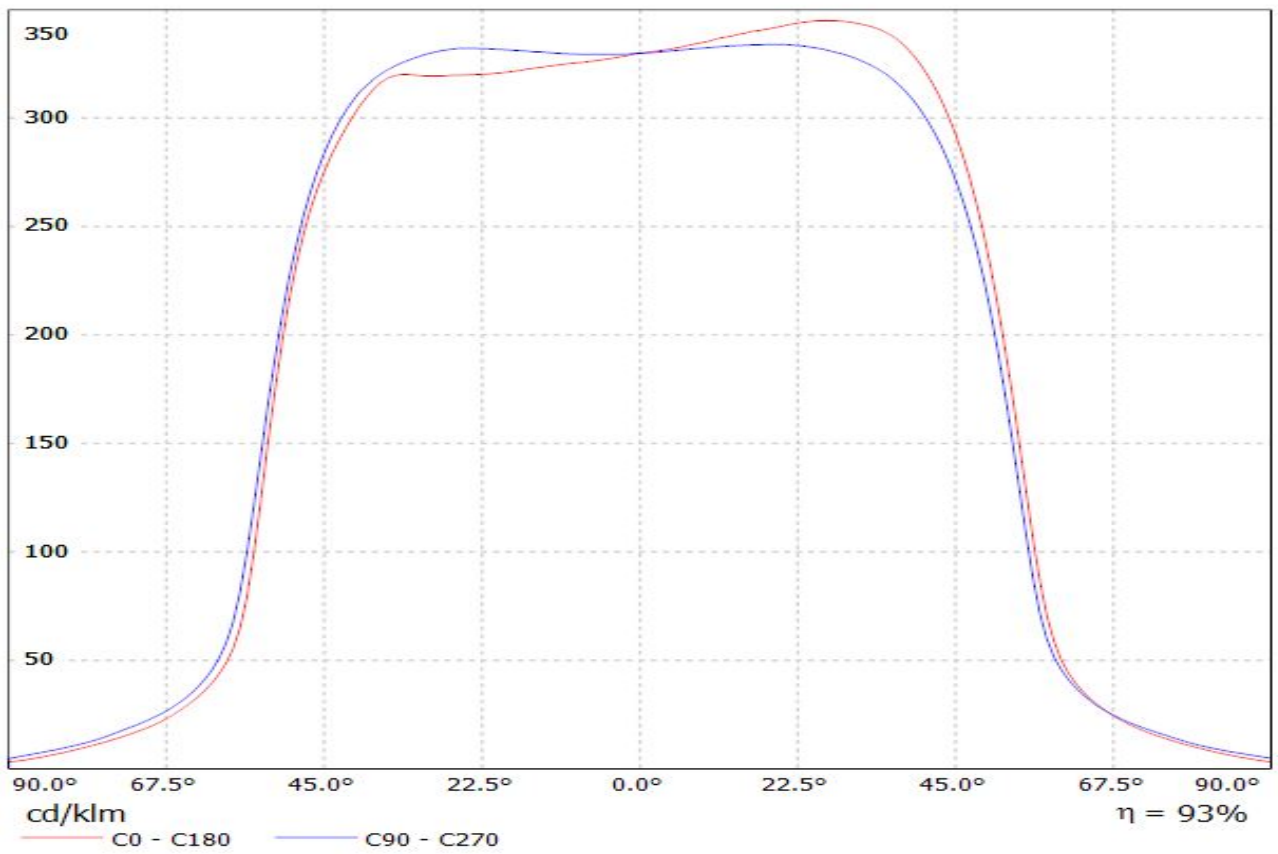

Luminaire: Ledil F14325_JENNY-8X1-CY_(MJT_6W_Les6)

Lamps: 1 x Seoul_MJT_6W_Les6mm_(SAWx0661A)_820.71lm@180mA_P=6.3909W_I=0.18A

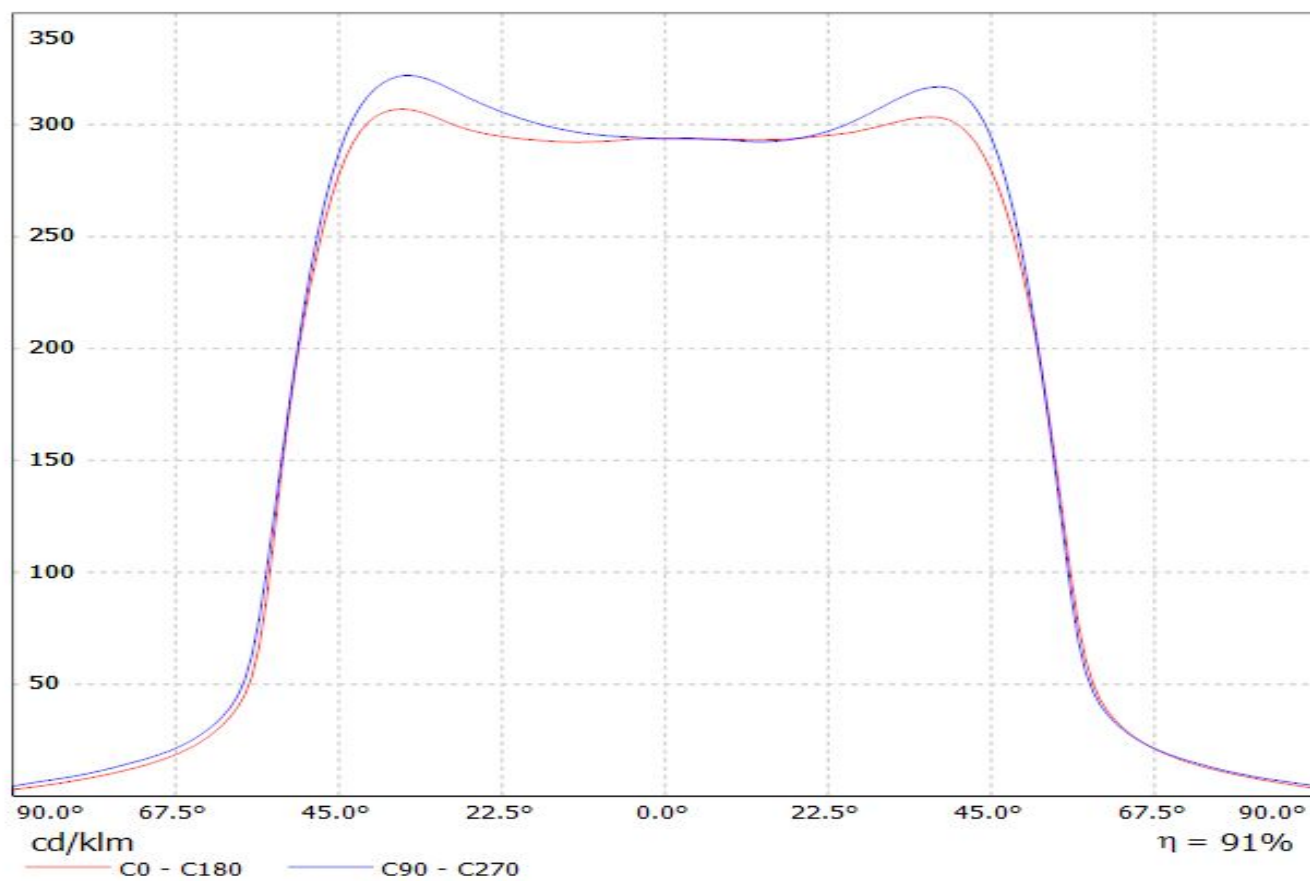

Luminaire: LEDiL Oy F14325_JENNY-8X1-CY_(SLE-G5_LES-6)
Lamps: 1 x Tridonic_SLE-G5_LES-6_3766.4lm@100mA

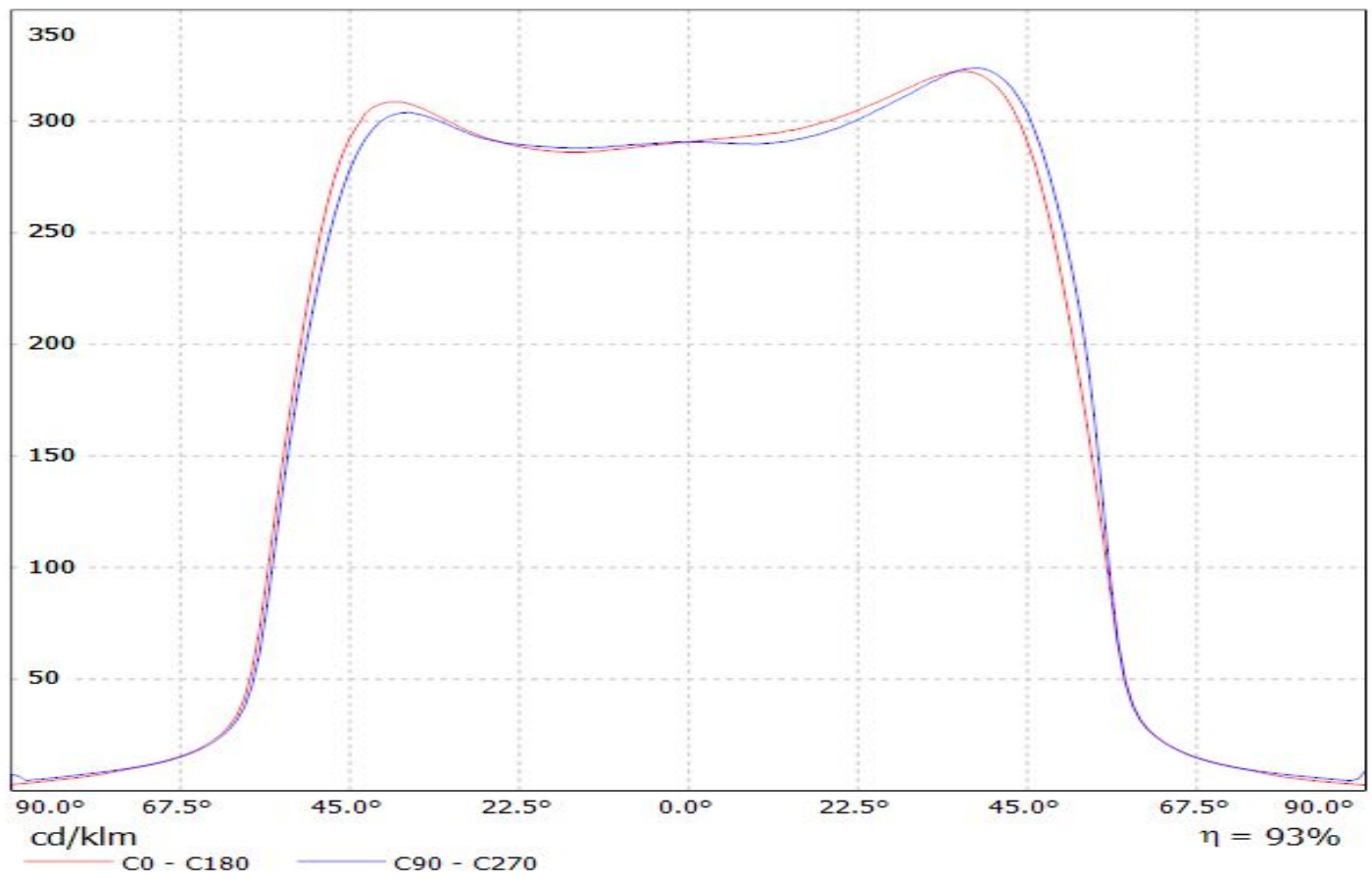

Luminaire: LEDiL Oy F14325_JENNY-8X1-CY_(SLE-G5_LES-11)
Lamps: 1 x Tridonic_SLE-G5_LES-11_9492lm@250mA

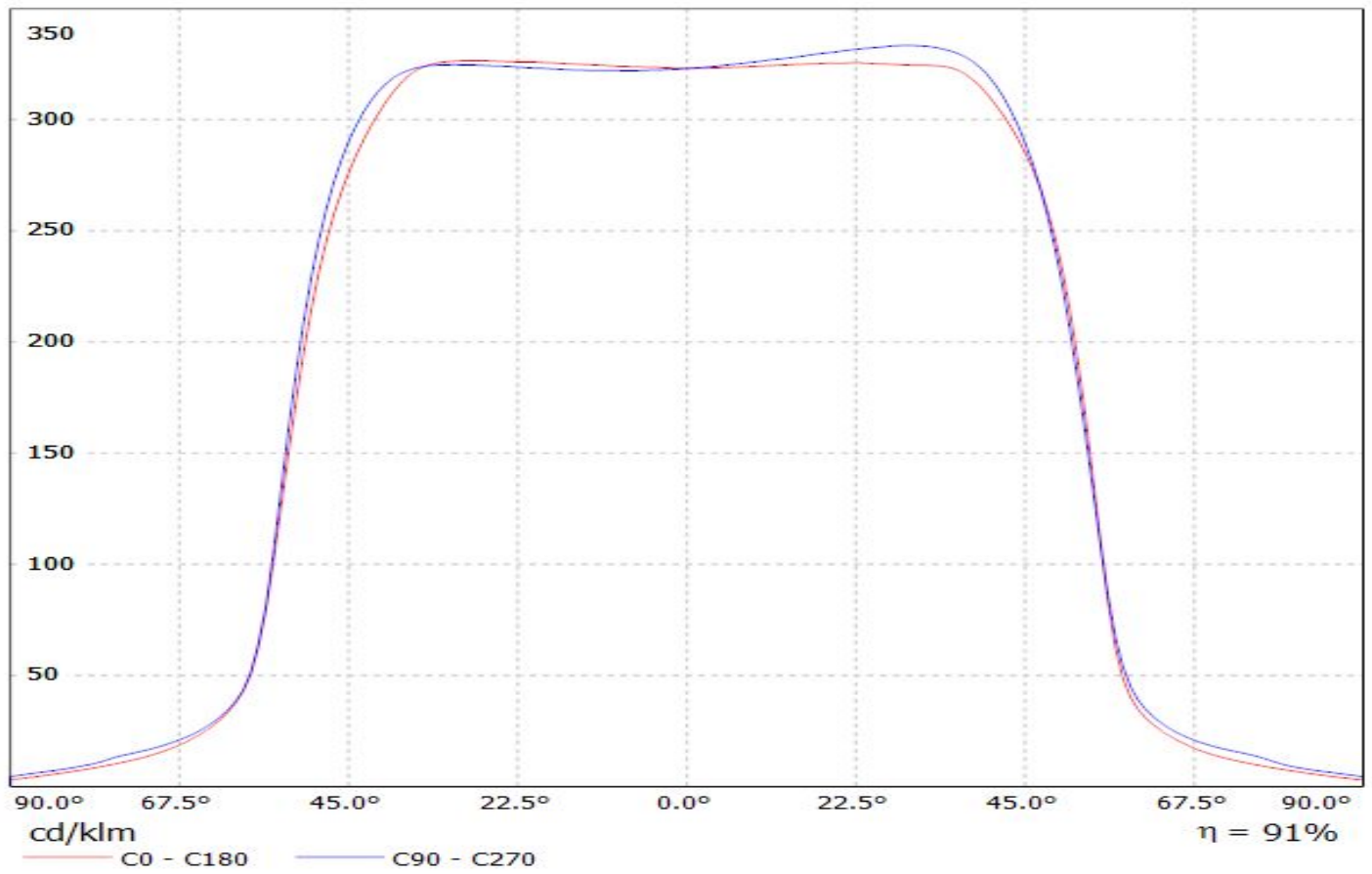

Luminaire: LEDiL Oy F14325_JENNY-8X1-CY_(V6)

Lamps: 1 x BRIDGELUX_V6_3500lm@250mA_P=40W_I=249.9mA

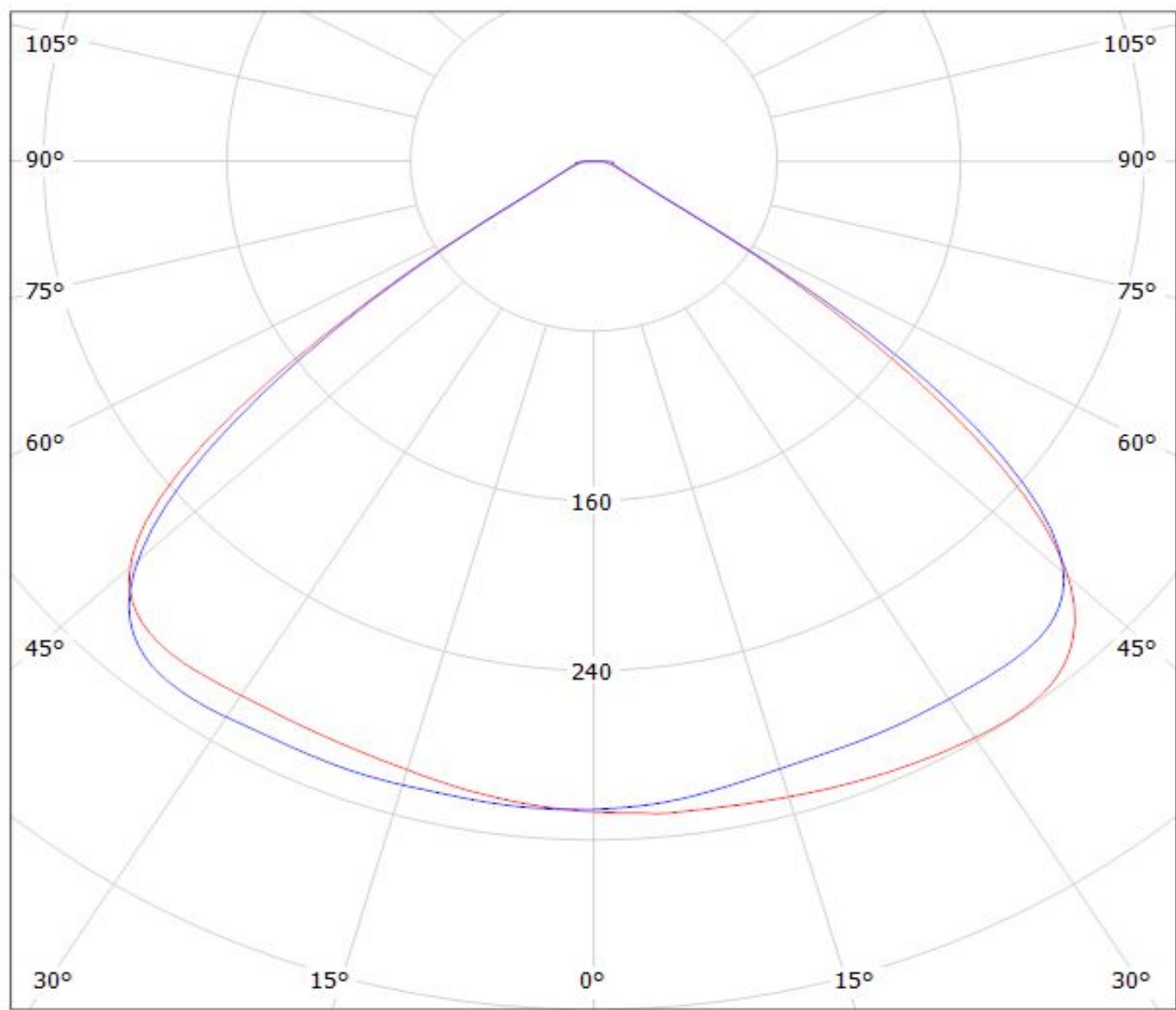

cd/klm

— C0 - C180 — C90 - C270

$\eta = 94\%$

Luminaire: LEDiL Oy F14325_JENNY-8X1-CY

Lamps: 1 x BRIDGELUX_V8_6900lm@250mA_P=70W_I=249.8mA

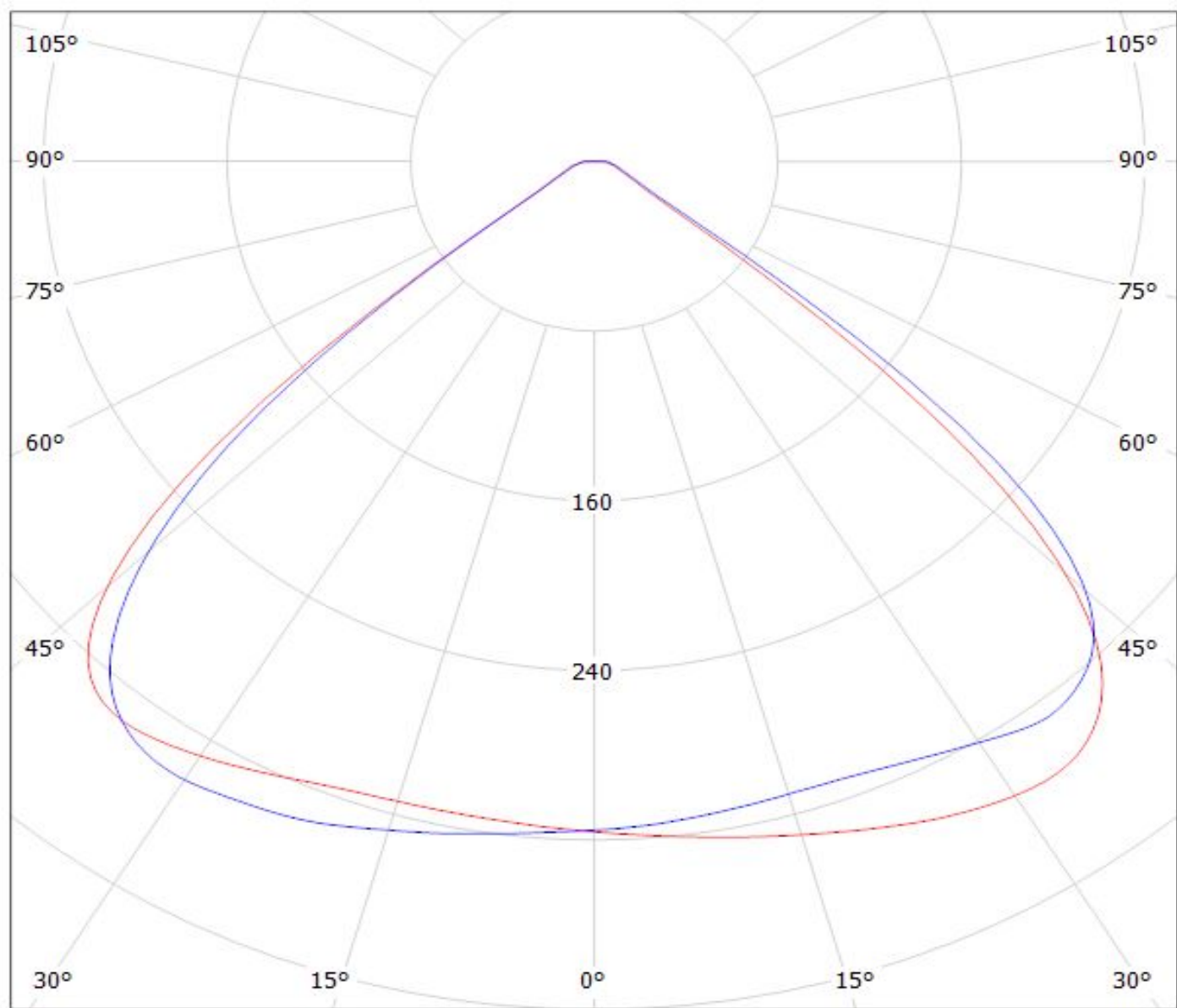

cd/klm

— C0 - C180

— C90 - C270

$\eta = 94\%$

Luminaire: LEDiL Oy F14325_JENNY-8X1-CY_(V10)

Lamps: 1 x BRIDGELUX_V10_(BXRE-30E1000B-X2)_6100lm@250mA_P=50W_I=249.9mA

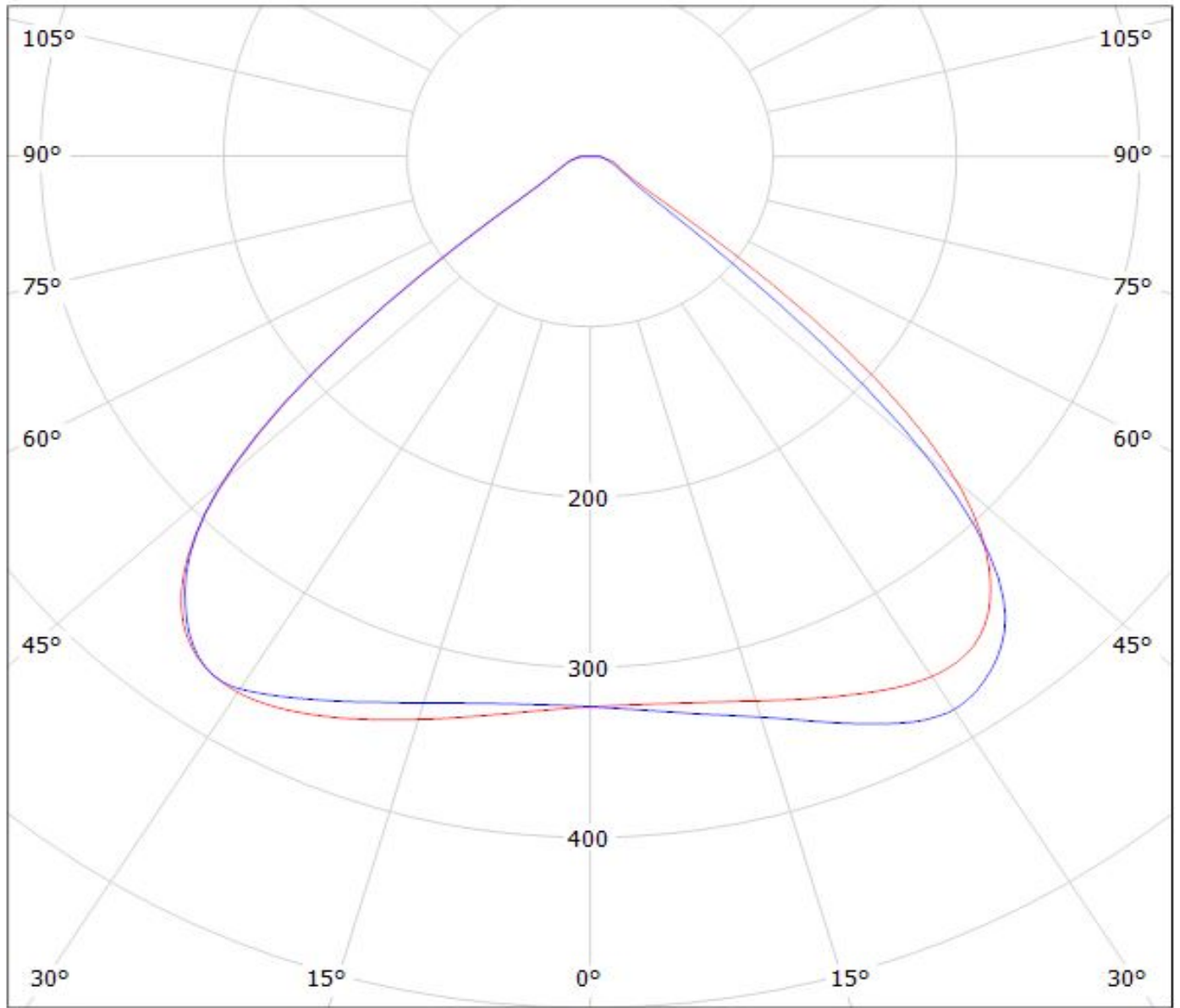

cd/klm

— C0 - C180

— C90 - C270

$\eta = 94\%$

Luminaire: Ledil Oy F14325_JENNY-8X1-CY_BRIDGELUX_V10_Gen7_SIMULATED
Lamps: 1 x BRIDGELUX V10 Gen7

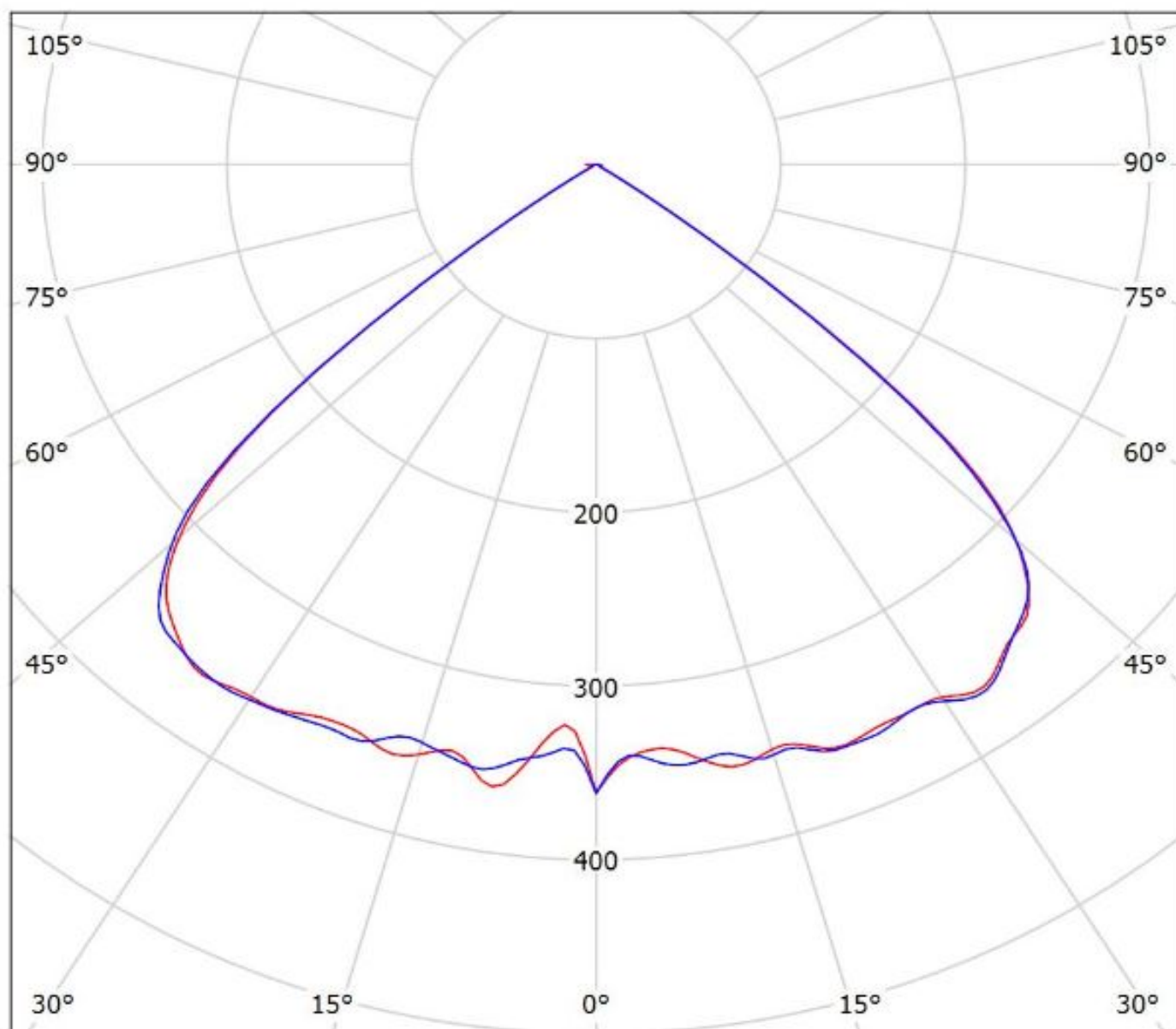

cd/klm

— C0 - C180

— C90 - C270

$\eta = 94\%$

Luminaire: LEDiL Oy F14531_JENNY-CY_(CLL010)

Lamps: 1 x CITIZEN_CLL010_x8_(CLL010-0305A1-303M1A2)_1658.8lm@250mA_P=18W_I=249.9mA

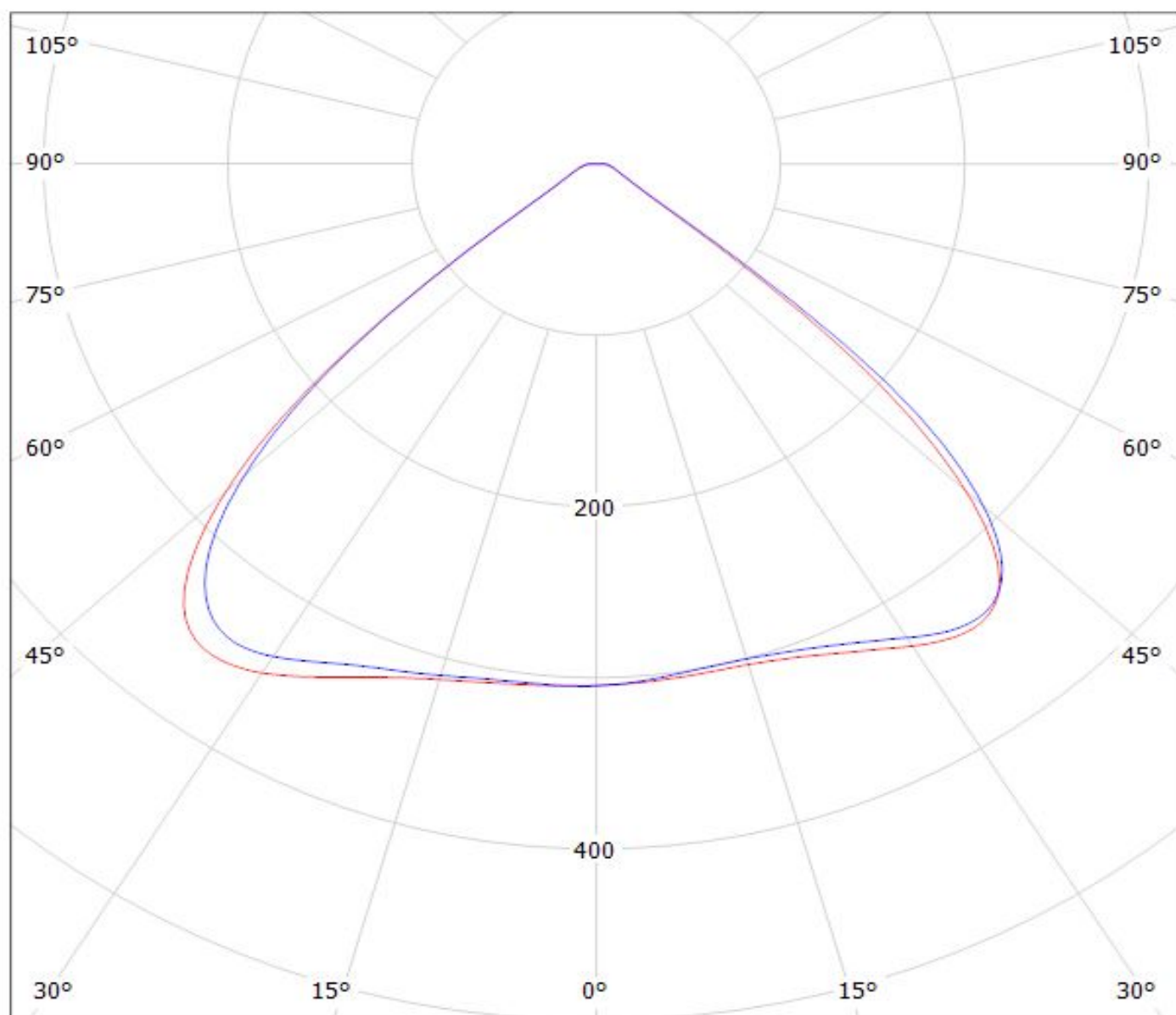

cd/klm

— C0 - C180

— C90 - C270

$\eta = 94\%$

Luminaire: LEDiL Oy F14325_JENNY-8X1-CY_(CLL022)

Lamps: 1 x CITIZEN_CLL022_x8_(CLL022-1204A5-030H7E1)_5900lm@250mA_P=69W_I=249.8mA

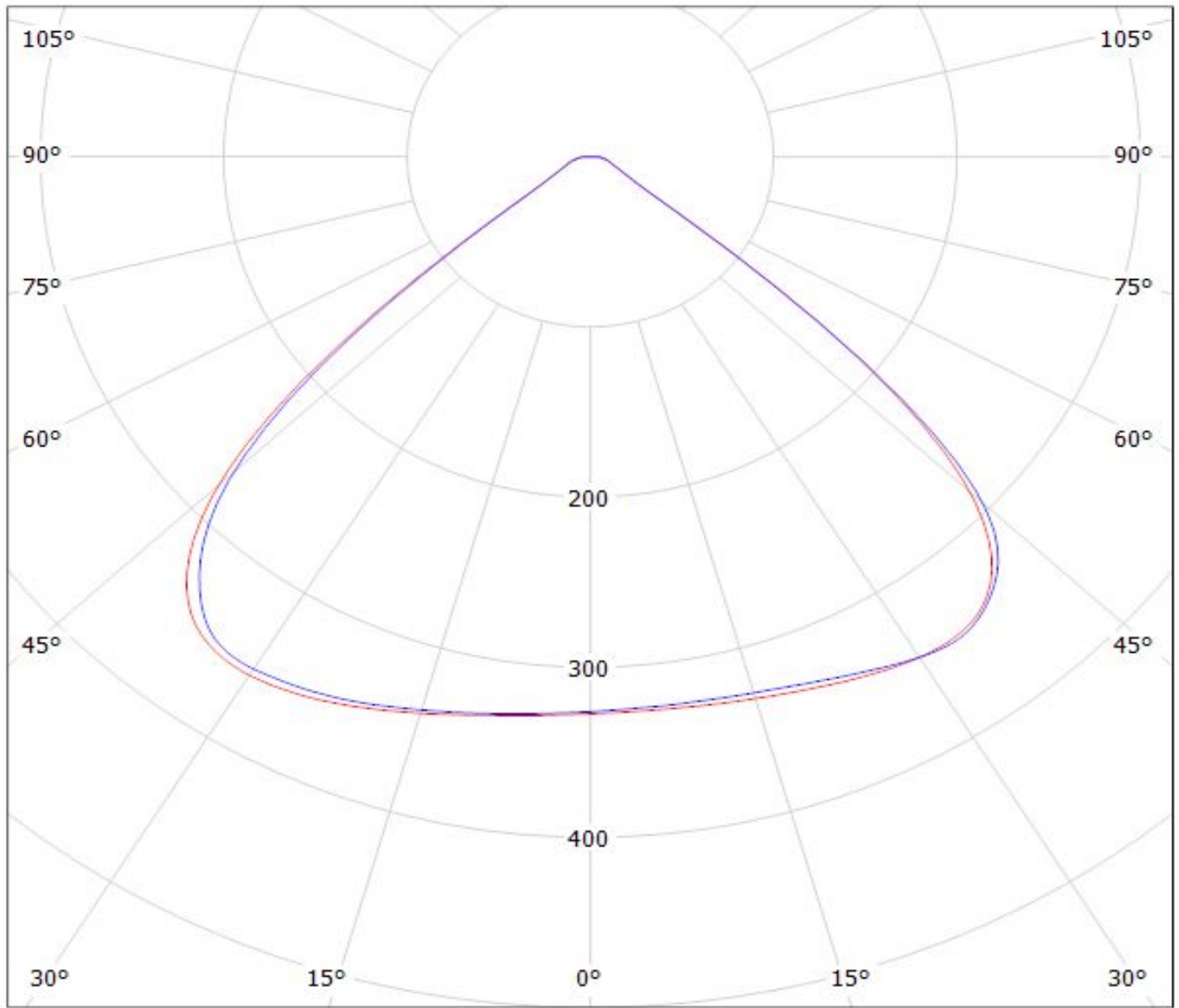

cd/klm

— C0 - C180 — C90 - C270

$\eta = 93\%$

Luminaire: Ledil F14325_JENNY-8X1-CY_(CLU700)
Lamps: 1 x Citizen_CLU700_394.637lm@100mA_P=2.8W_I=0.10A

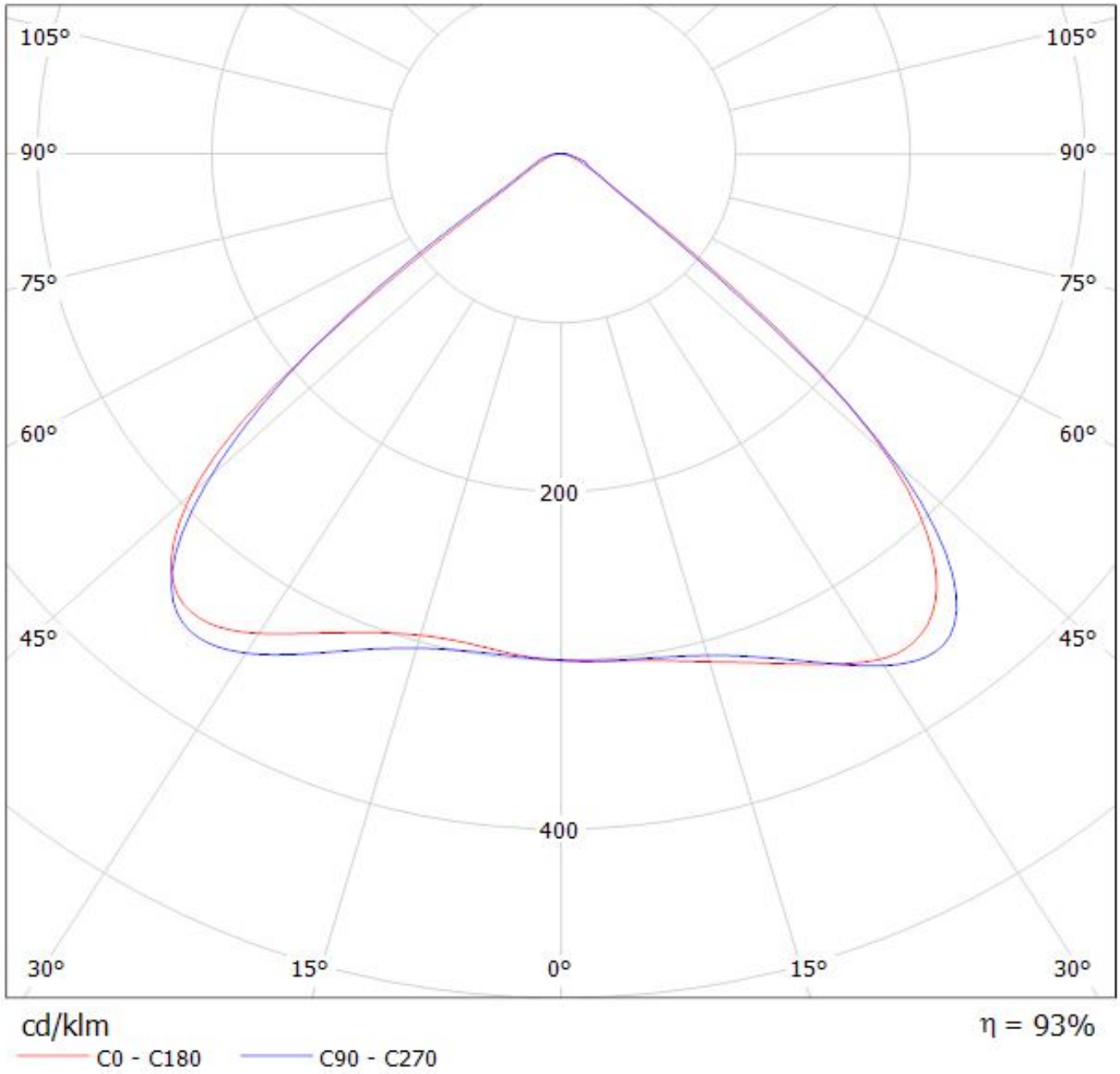

Luminaire: LEDiL Oy F14325_JENNY-8X1-CY_(CXA1520)

Lamps: 1 x CREE_CXA1520_(CXA1520-30F-N4-N0H-0001)_976.326lm@250mA_U=8.36855W_I=249.8mA

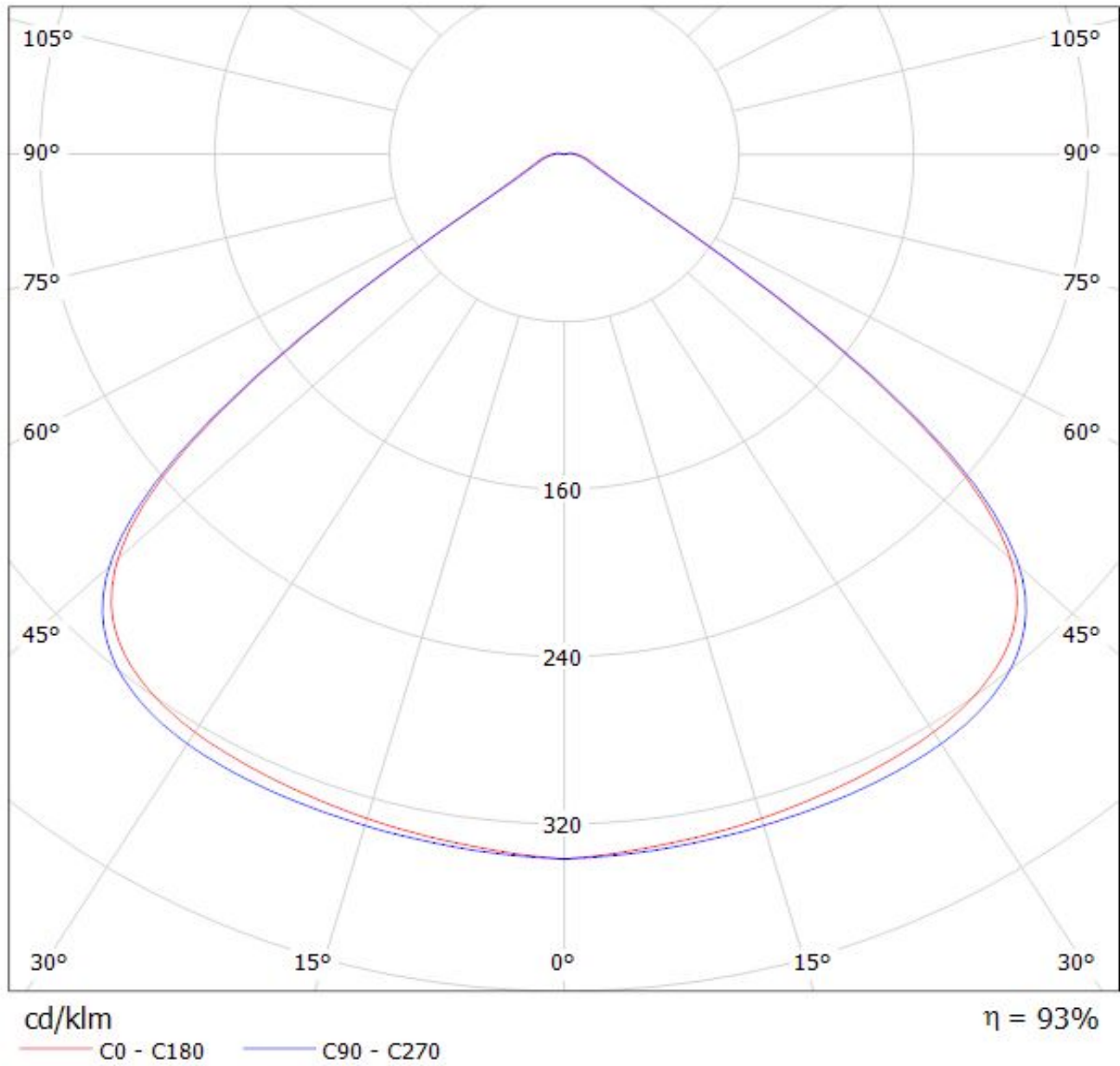

Luminaire: LEDiL Oy F14325_JENNY-8X1-CY_(MK-R)
Lamps: 1 x MK-R_2820lm@250mA_CCT=3276K_P=22W_I=249.9mA

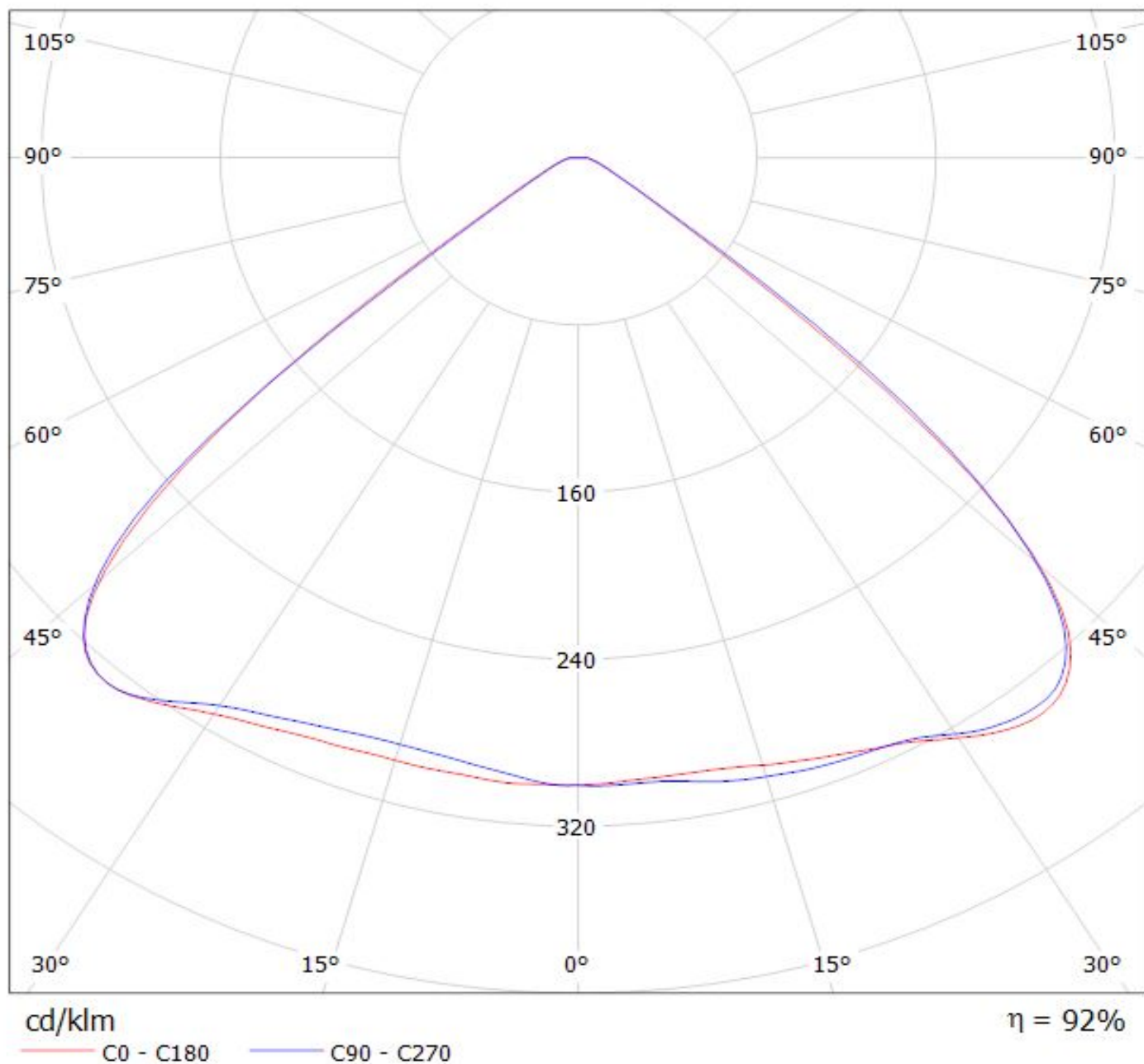

Luminaire: LEDiL Oy F14325_JENNY-8X1-CY_(CXA1310)
Lamps: 1 x CREE_CXA1310_(CXA1310-30H-G4-F0Y-00001)
_2900lm@250mA_CCT=3000K_P=34W_I=249.8mA

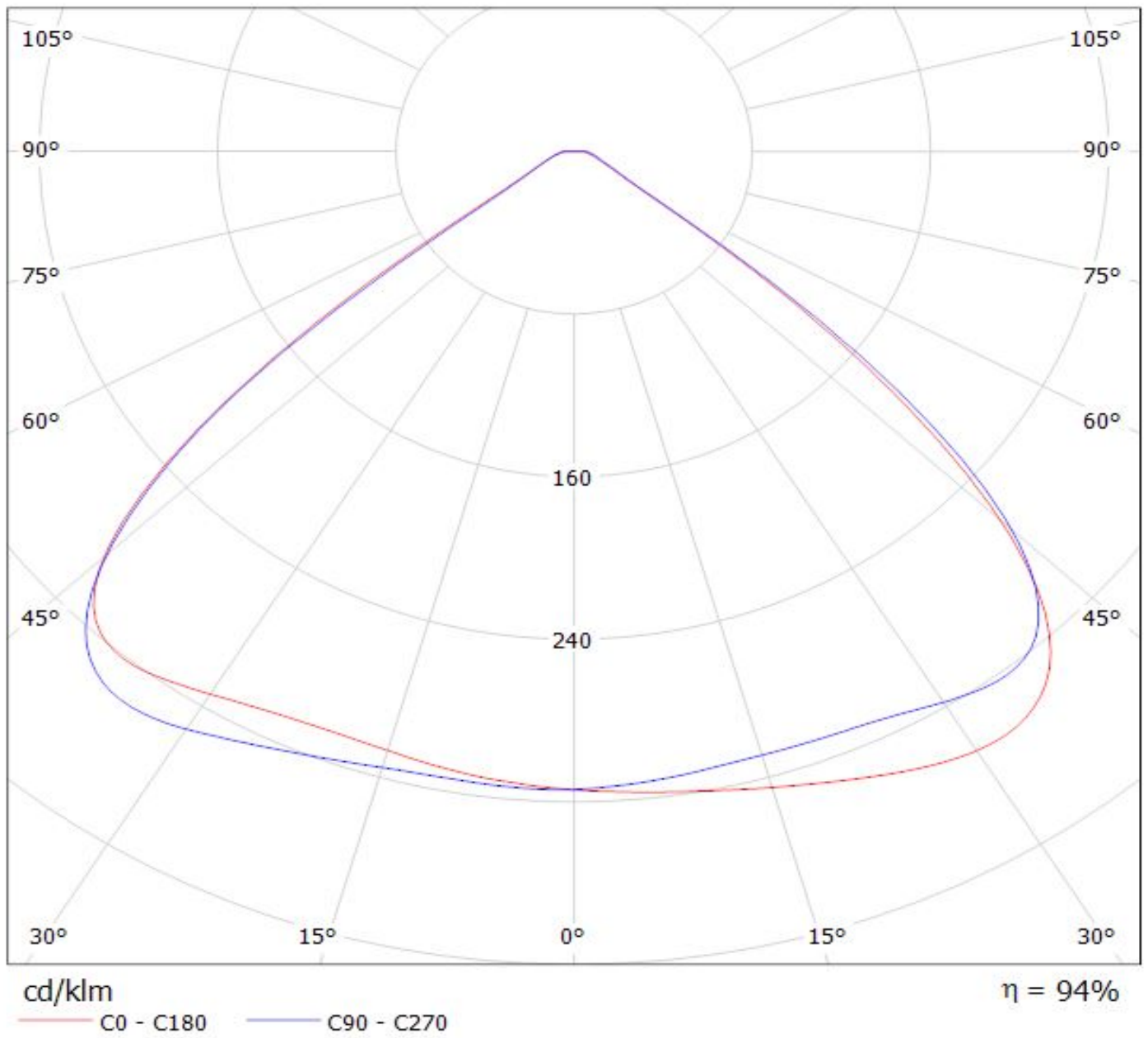

Luminaire: LEDiL Oy F14325_JENNY-8X1-CY_(XM-L)
Lamps: 1 x CREE_XM-L_EZW_1040lm@250mA_P=12W_I=249.9mA

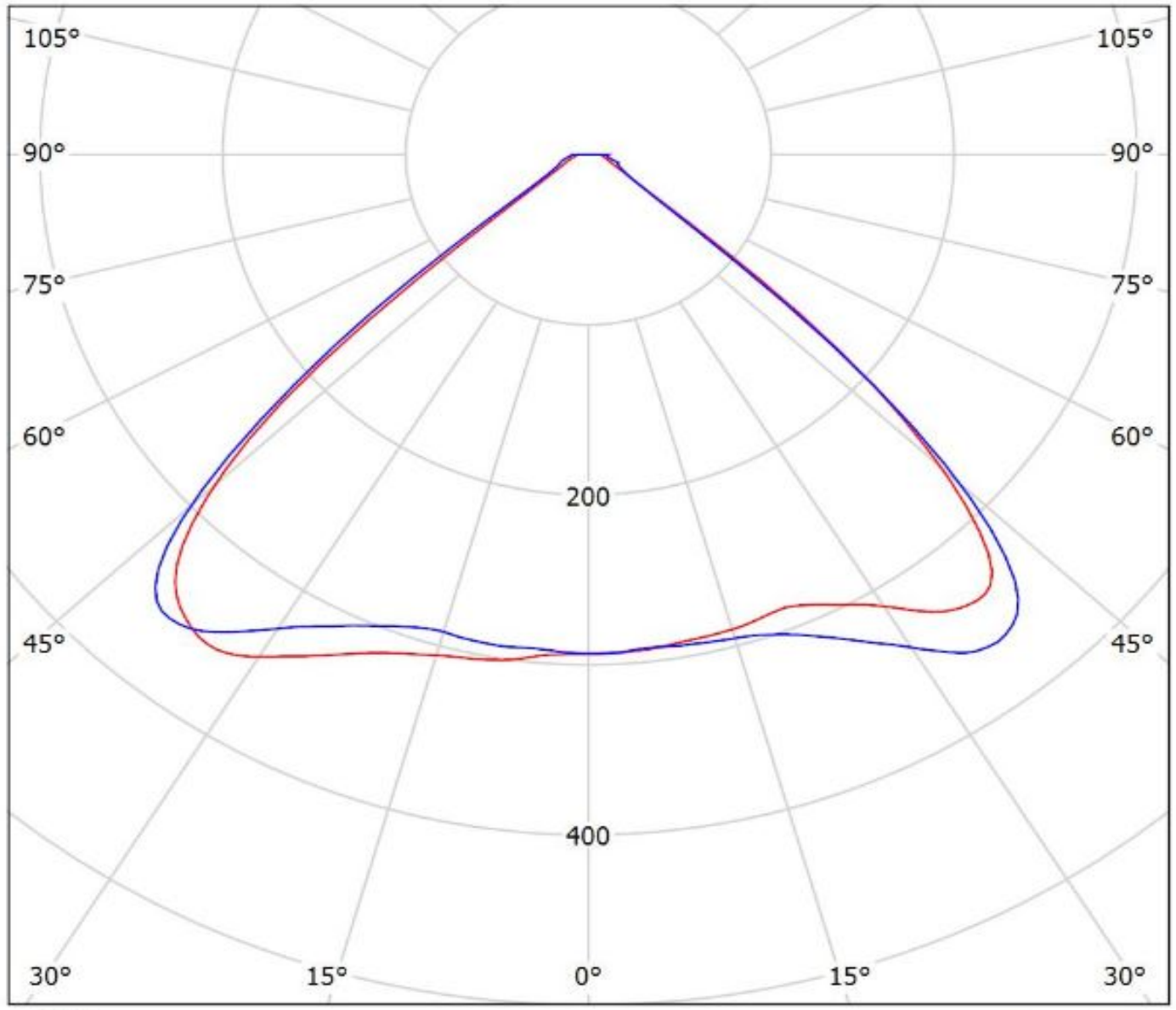

cd/klm
— C0 - C180 — C90 - C270

$\eta = 94\%$

Ledil F14325_JENNY-8X1-CY_(XPH50) / LDC (Polar)

Luminaire: Ledil F14325_JENNY-8X1-CY_(XPH50)

Lamps: 1 x XHP50_warm_white_1686.8lm@250mA_P=11.2166W_I=0.25A

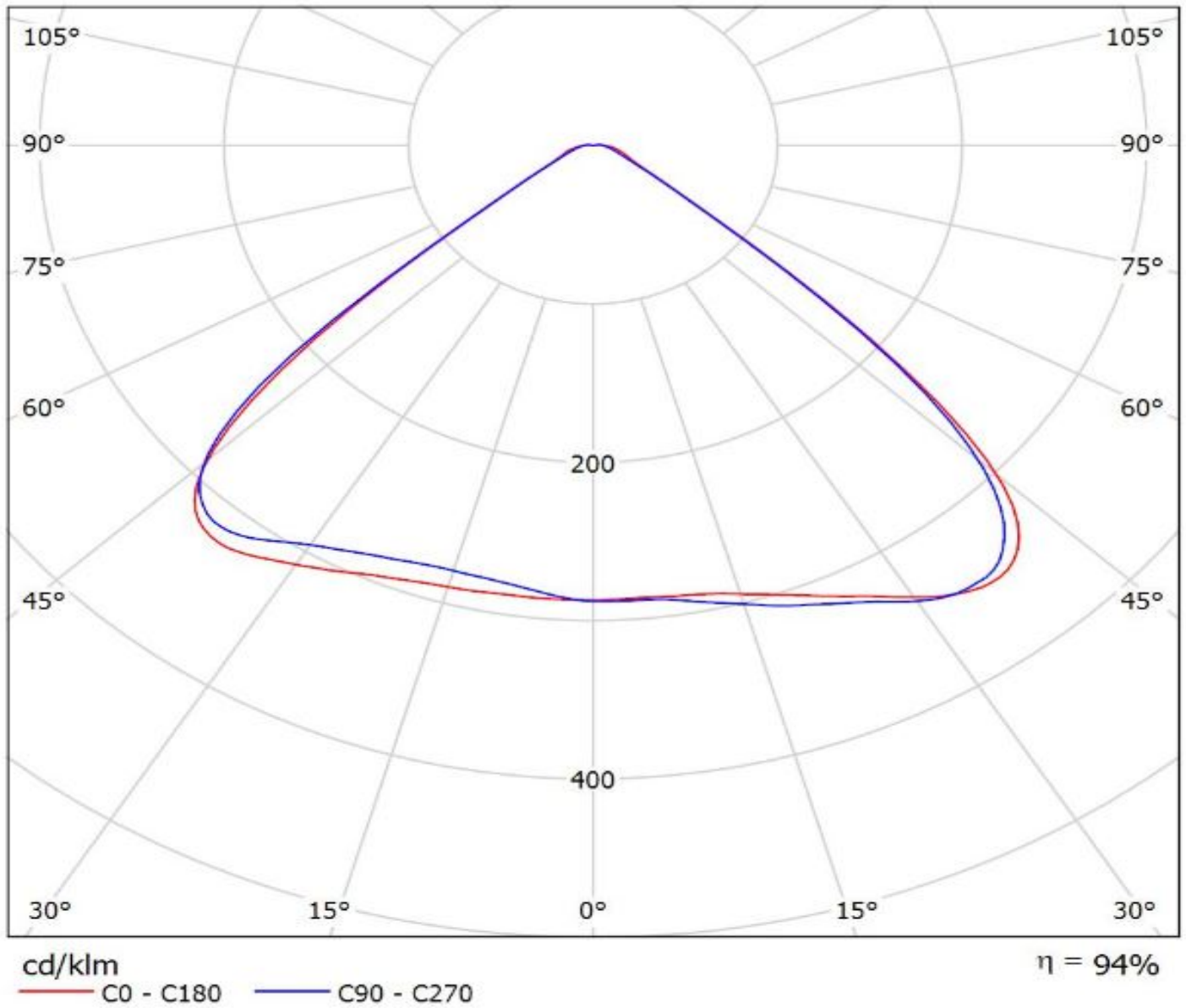

Luminaire: LEDiL Oy F14325_JENNY-8X1-CY_(LUXEON_M)
Lamps: 1 x LUXEON_M_(LXR7-SW40)_2540lm@250mA_P=21W_I=249.8mA

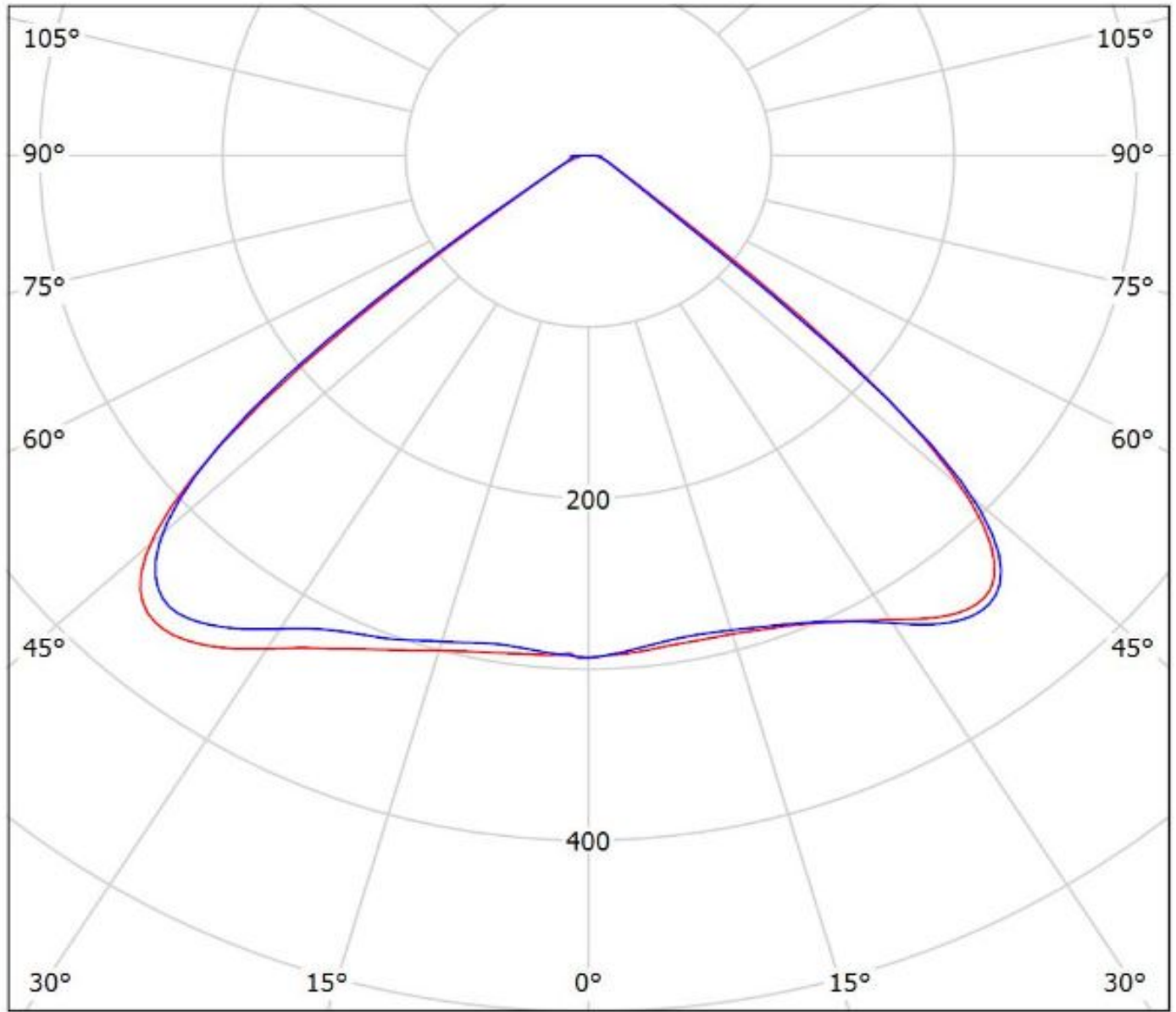

cd/klm

— C0 - C180 — C90 - C270

$\eta = 94\%$

Ledil F14325_JENNY-8X1-CY_(LUXEON_5258) / LDC (Polar)

Luminaire: Ledil F14325_JENNY-8X1-CY_(LUXEON_5258)

Lamps: 1 x LUXEON_5258_(24VOLTS)_2460.584lm@800mA_CCT=2700K_P=18.592W_I=0.8A

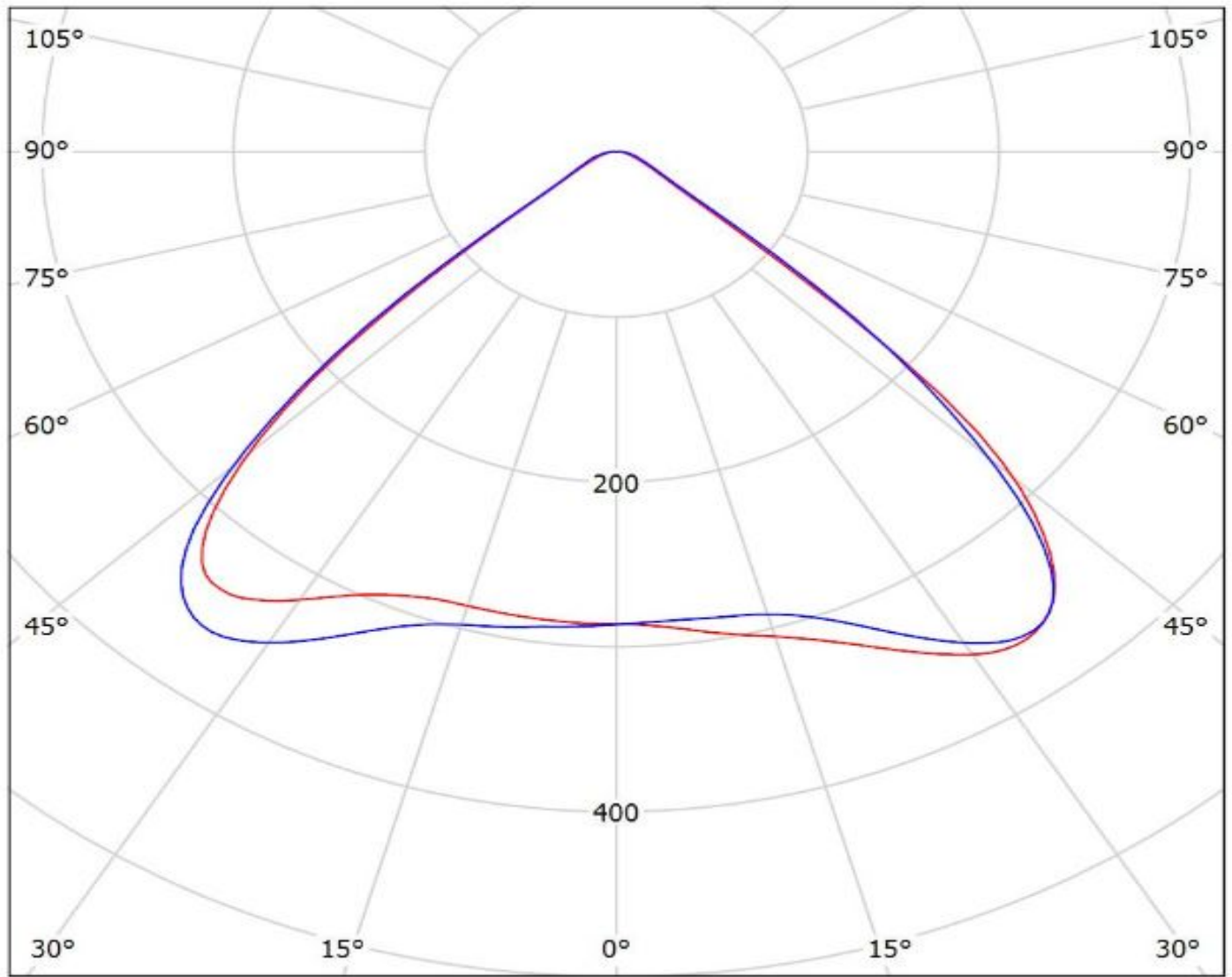

cd/klm

— C0 - C180 — C90 - C270

$\eta = 94\%$

Luminaire: LEDiL Oy F14325_JENNY-8X1-CY_(NSMx286M)

Lamps: 1 x NICHIA_NSMx286M_(NSML286ME)_2680lm@100mA_P=27W_I=100.1mA

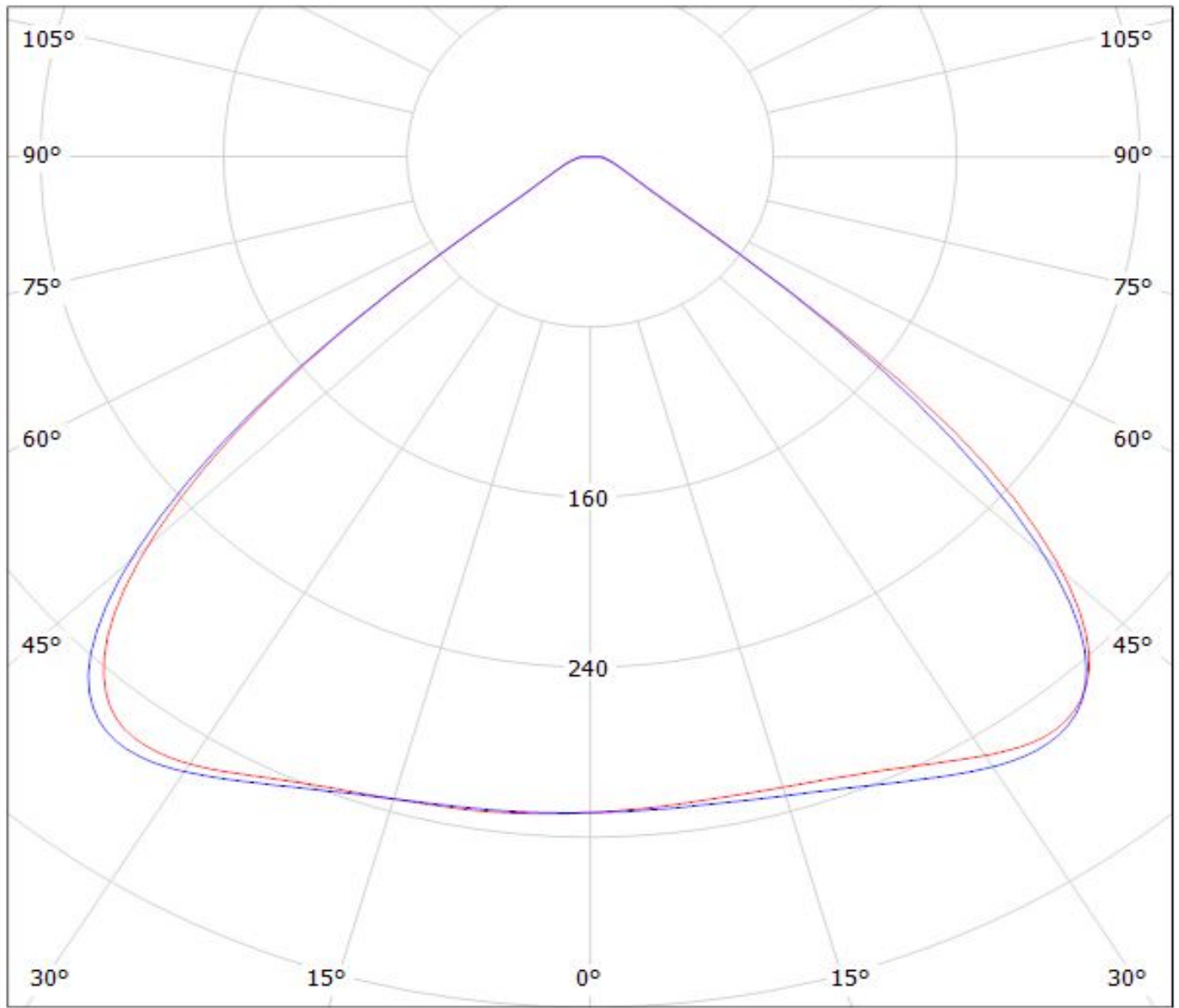

cd/klm

— C0 - C180 — C90 - C270

$\eta = 94\%$

Luminaire: LEDiL Oy F14325_JENNY-8X1-CY_(P6)

Lamps: 1 x OSRAM_SOLERIQ_P6_(GW_MAFJB1.EM)_5550lm@250mA_P=48W_I=249.9mA

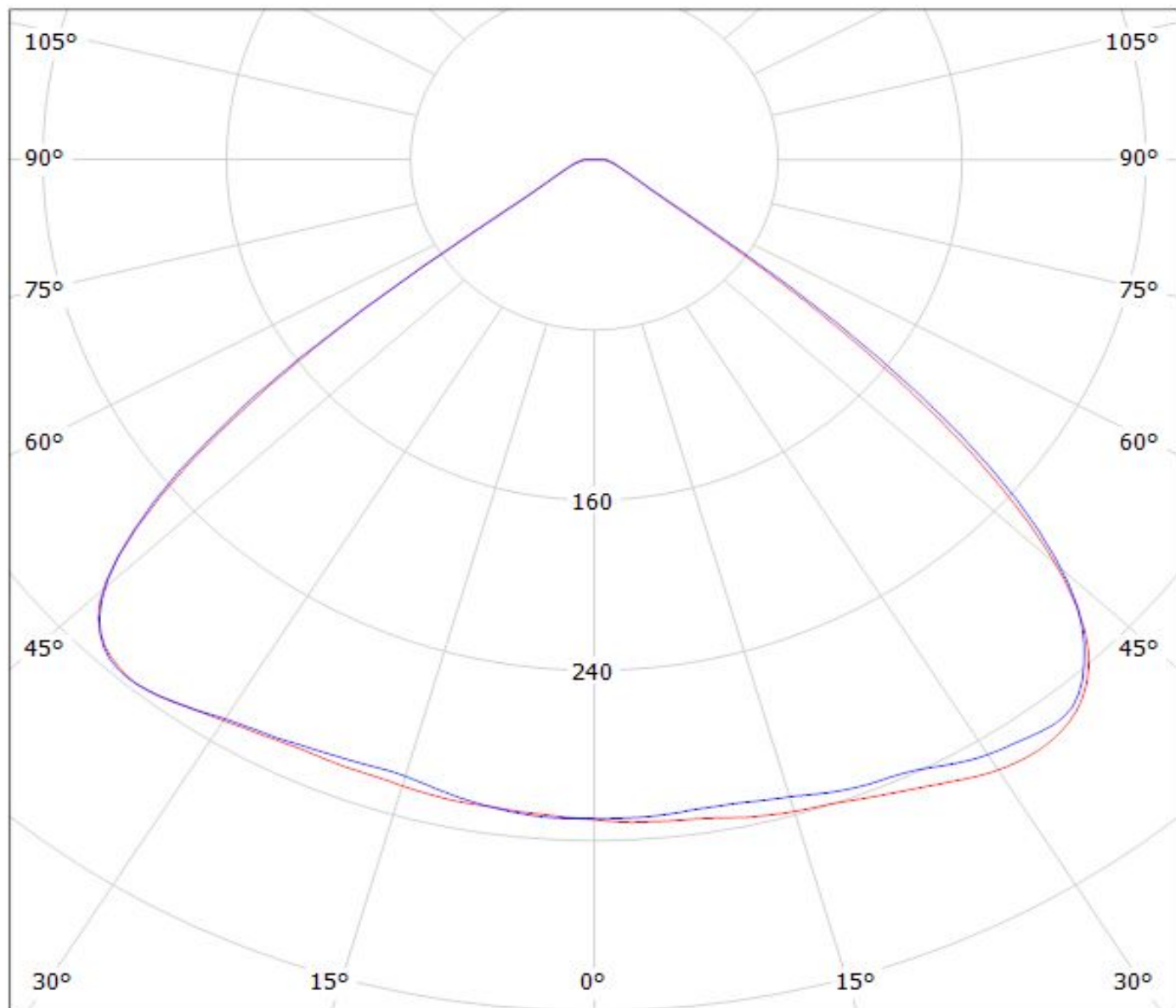

cd/klm

— C0 - C180

— C90 - C270

$\eta = 94\%$

Luminaire: LEDiL Oy F14325_JENNY-8X1-CY_(P9)

Lamps: 1 x OSRAM_SOLERIQ_P9_(GW_MAFJB1.EM)_7200lm@250mA_P=55W_I=249.8mA

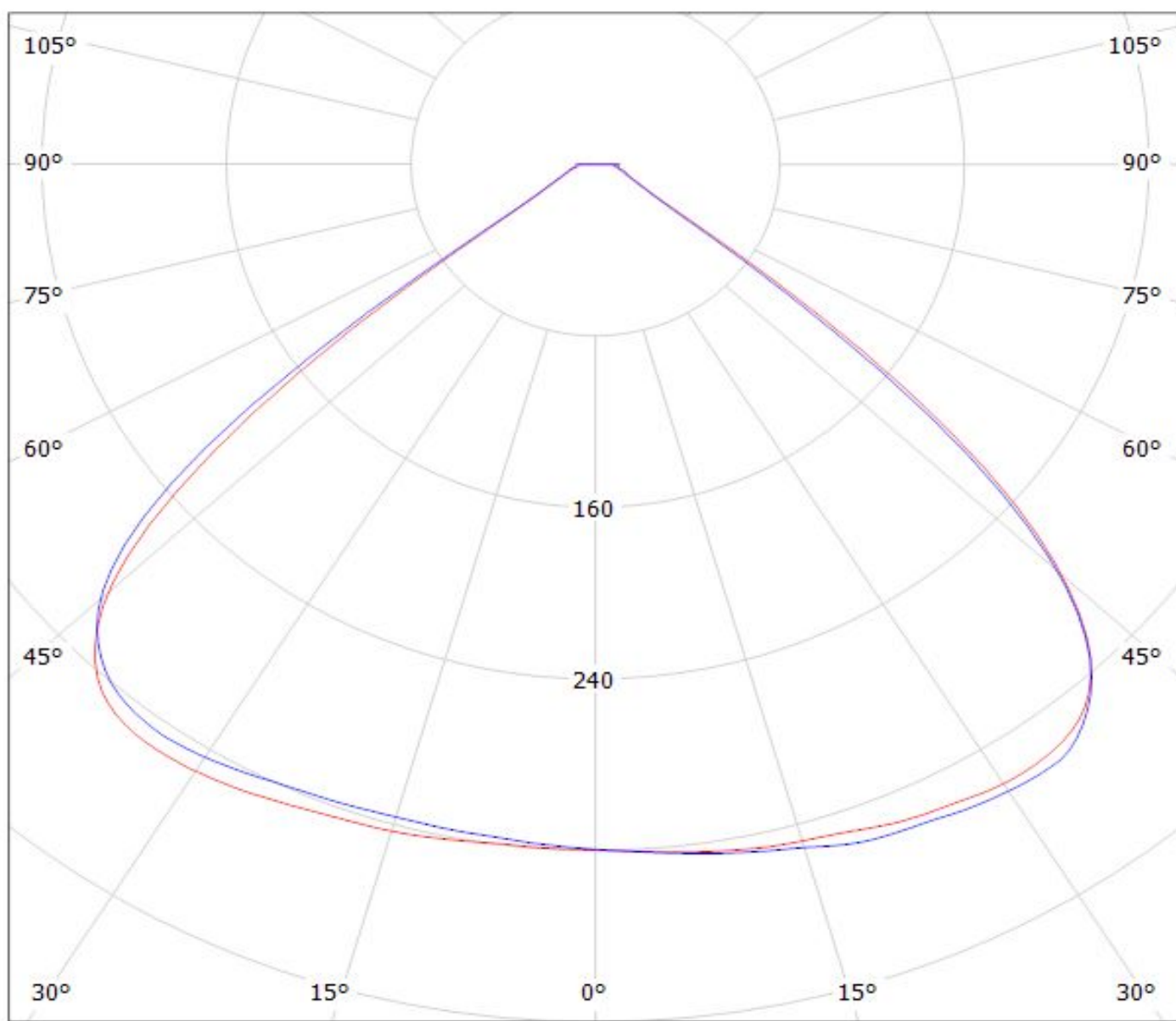

cd/klm

— C0 - C180

— C90 - C270

$\eta = 94\%$

Ledil F14326_JENNY-8X1-T4_(Duris_S8) / LDC (Polar)

Luminaire: Ledil F14326_JENNY-8X1-T4_(Duris_S8)

Lamps: 1 x Osram_Duris_S8_(GW_P9LMS1.EC)_1611.928lm@800mA_CCT=2857K_P=14.4W_I=0.8A

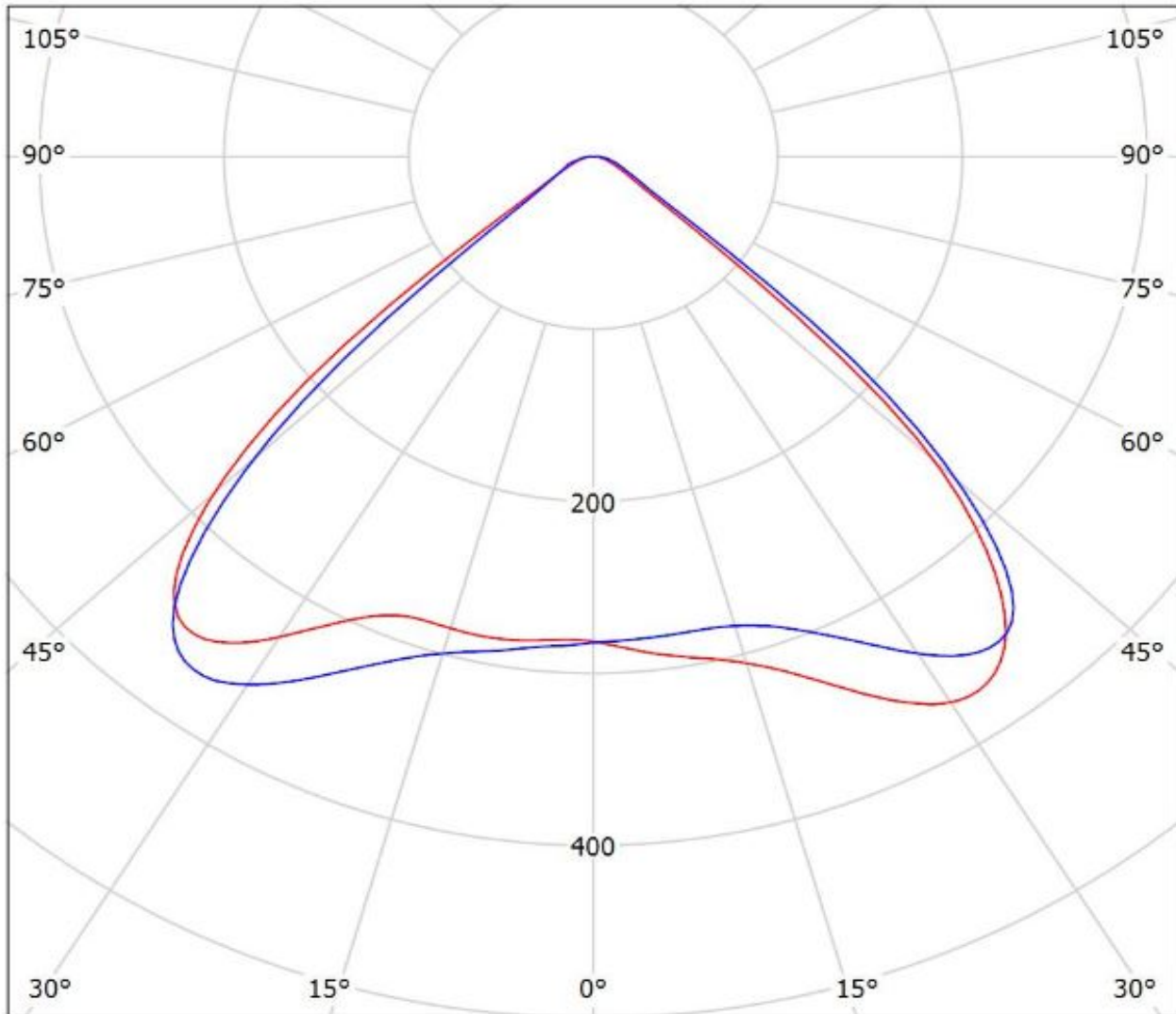

cd/klm

— C0 - C180 — C90 - C270

$\eta = 94\%$

Luminaire: Ledil Oy F14325_JENNY-8X1-CY_(Soleriq_S9)_SIMULATED
Lamps: 1 x Osram Soleriq S9 (GW KAFJB3.EM)

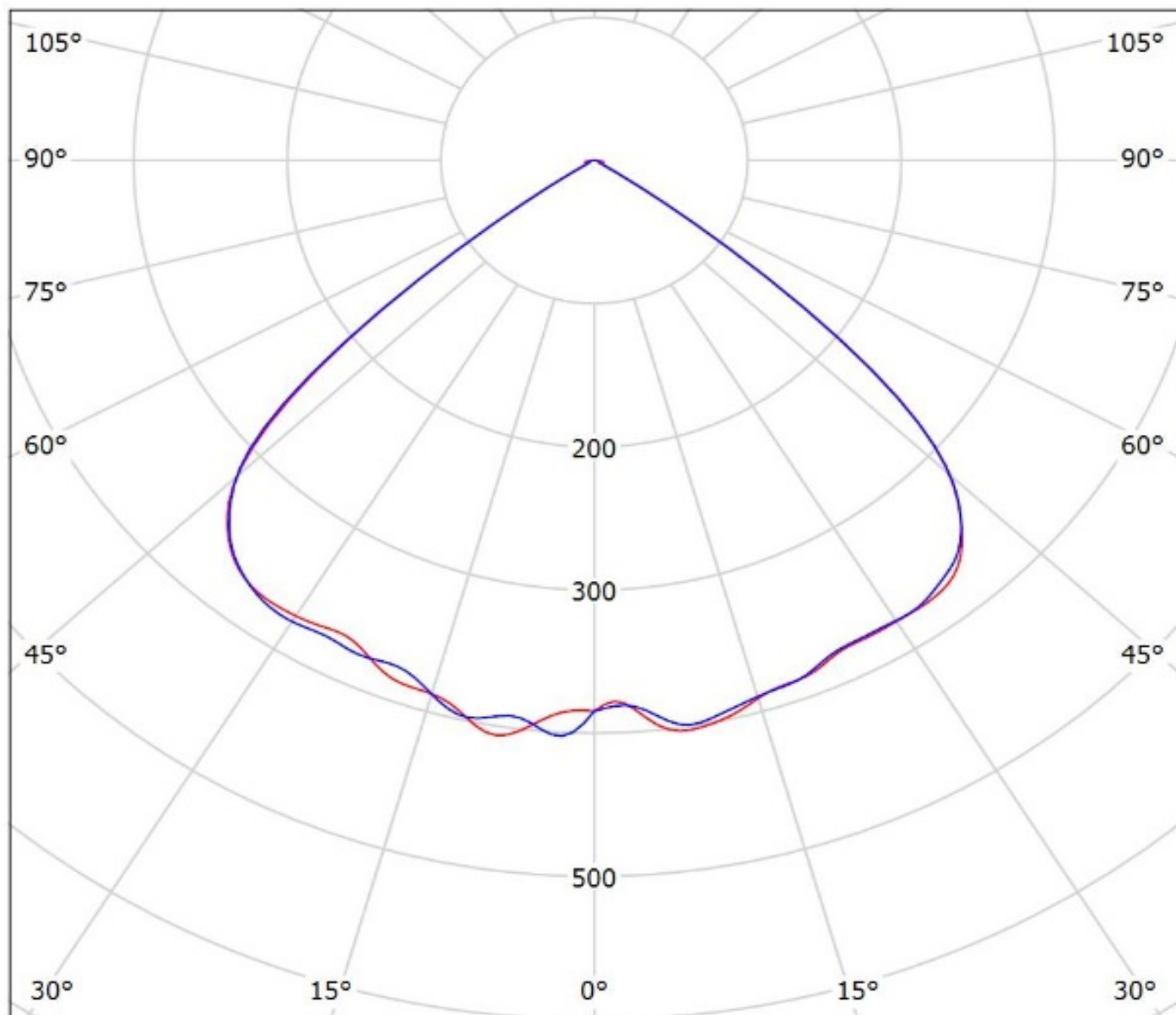

cd/klm

— C0 - C180 — C90 - C270

$\eta = 100\%$

Luminaire: LEDiL Oy FCN14648_JENNY-CY_(COB_D_LES_9.8mm)

Lamps: 1 x Samsung_COB_D_series_LES_9.8mm_LC013D_534.999lm@100mA_P=3.1948W_I=0.100A (x8)

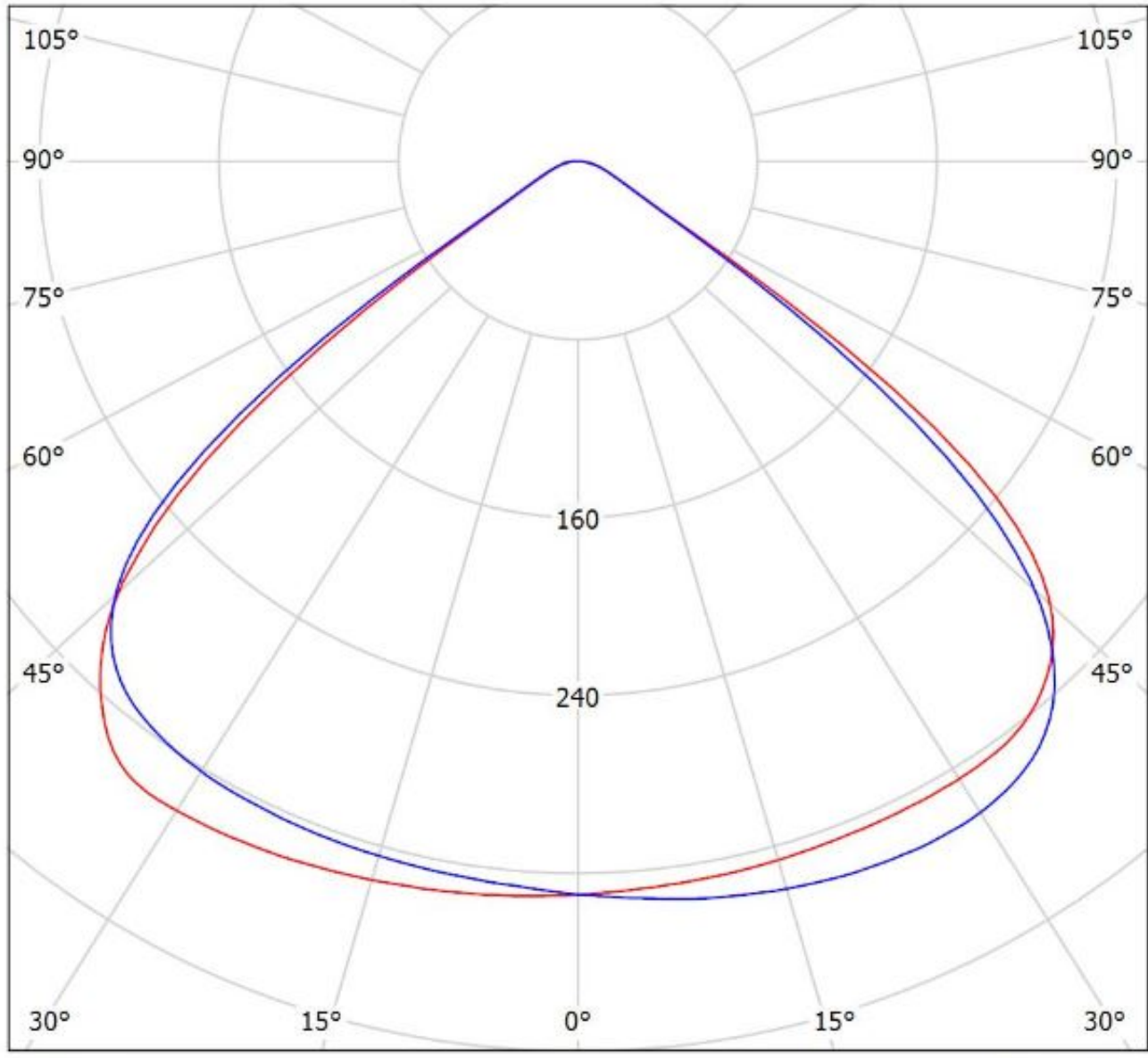

cd/klm

— C0 - C180 — C90 - C270

$\eta = 94\%$

Luminaire: Ledil F14325_JENNY-8X1-CY_(MJT_12W_Les9,8)

Lamps: 1 x Seoul_MJT_12W_Les9.8mm_(SAWx1063A)_1245.58lm@250mA_P=8.30025W_I=0.25A

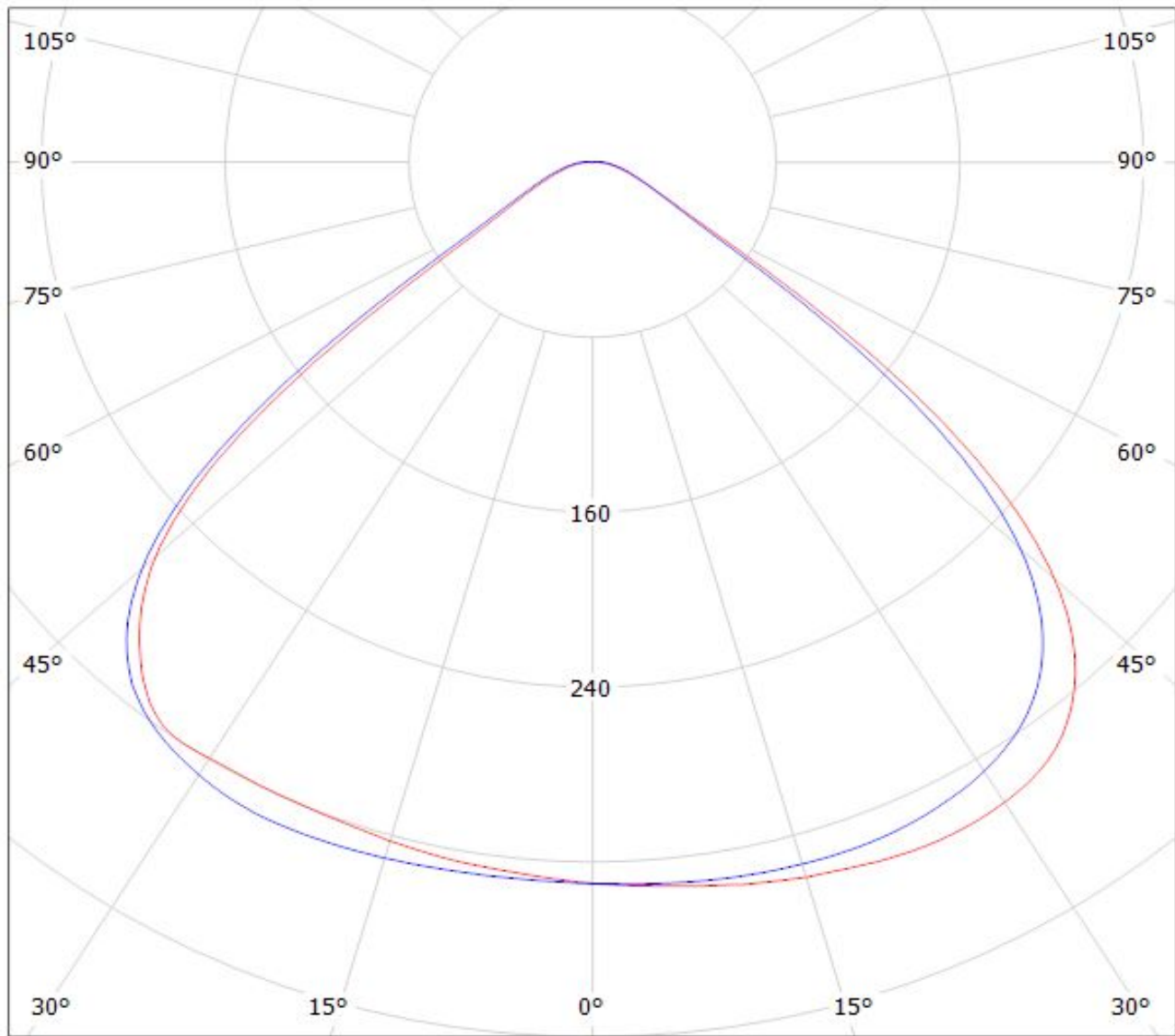

cd/klm

$\eta = 93\%$

— C0 - C180 — C90 - C270

Luminaire: Ledil F14325_JENNY-8X1-CY_(MJT_6W_Les6)

Lamps: 1 x Seoul_MJT_6W_Les6mm_(SAWx0661A)_820.711lm@180mA_P=6.3909W_I=0.18A

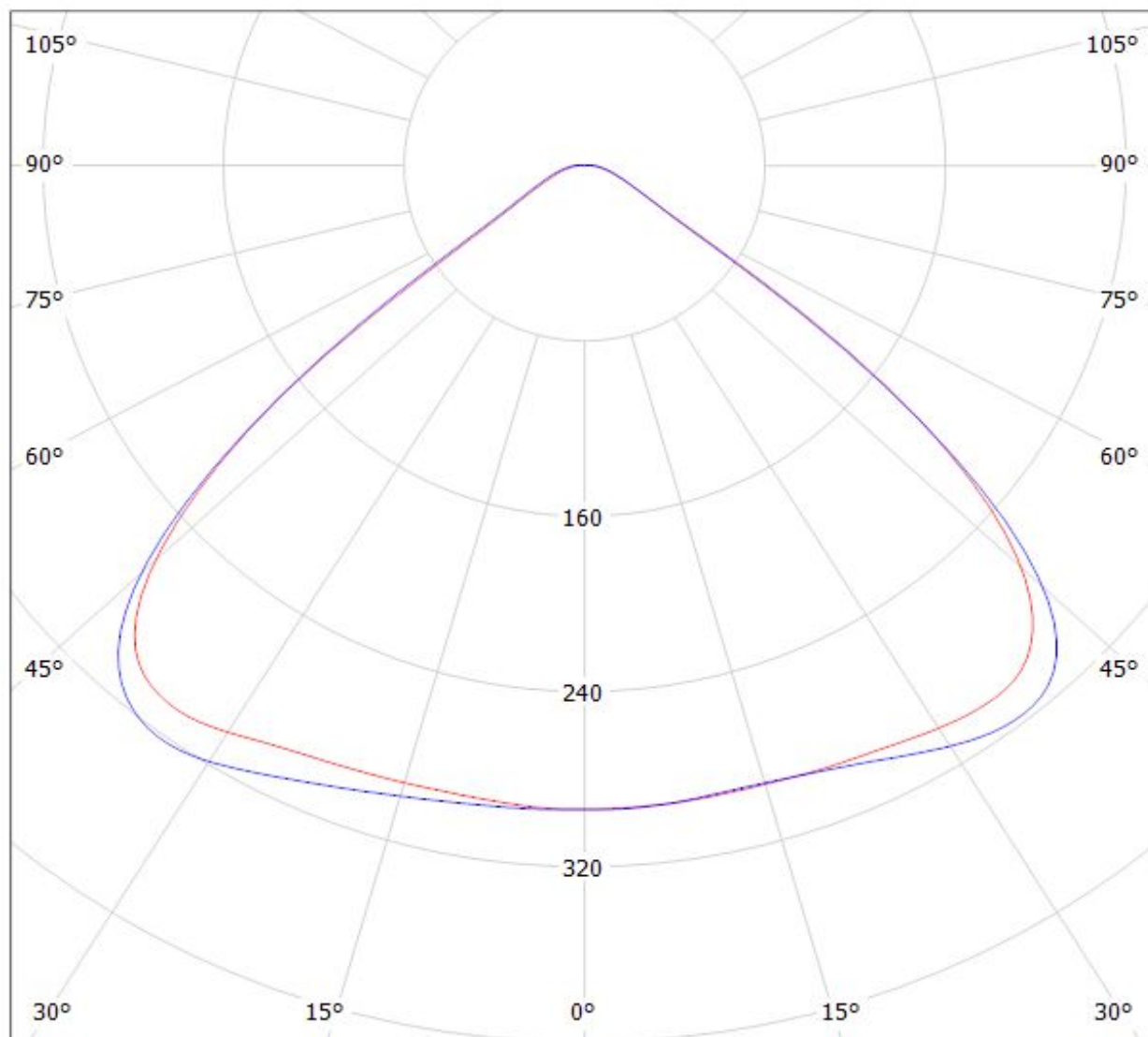

cd/klm

— C0 - C180

— C90 - C270

$\eta = 91\%$

Luminaire: LEDiL Oy F14325_JENNY-8X1-CY_(SLE-G5_LES-6)
Lamps: 1 x Tridonic_SLE-G5_LES-6_3766.4lm@100mA

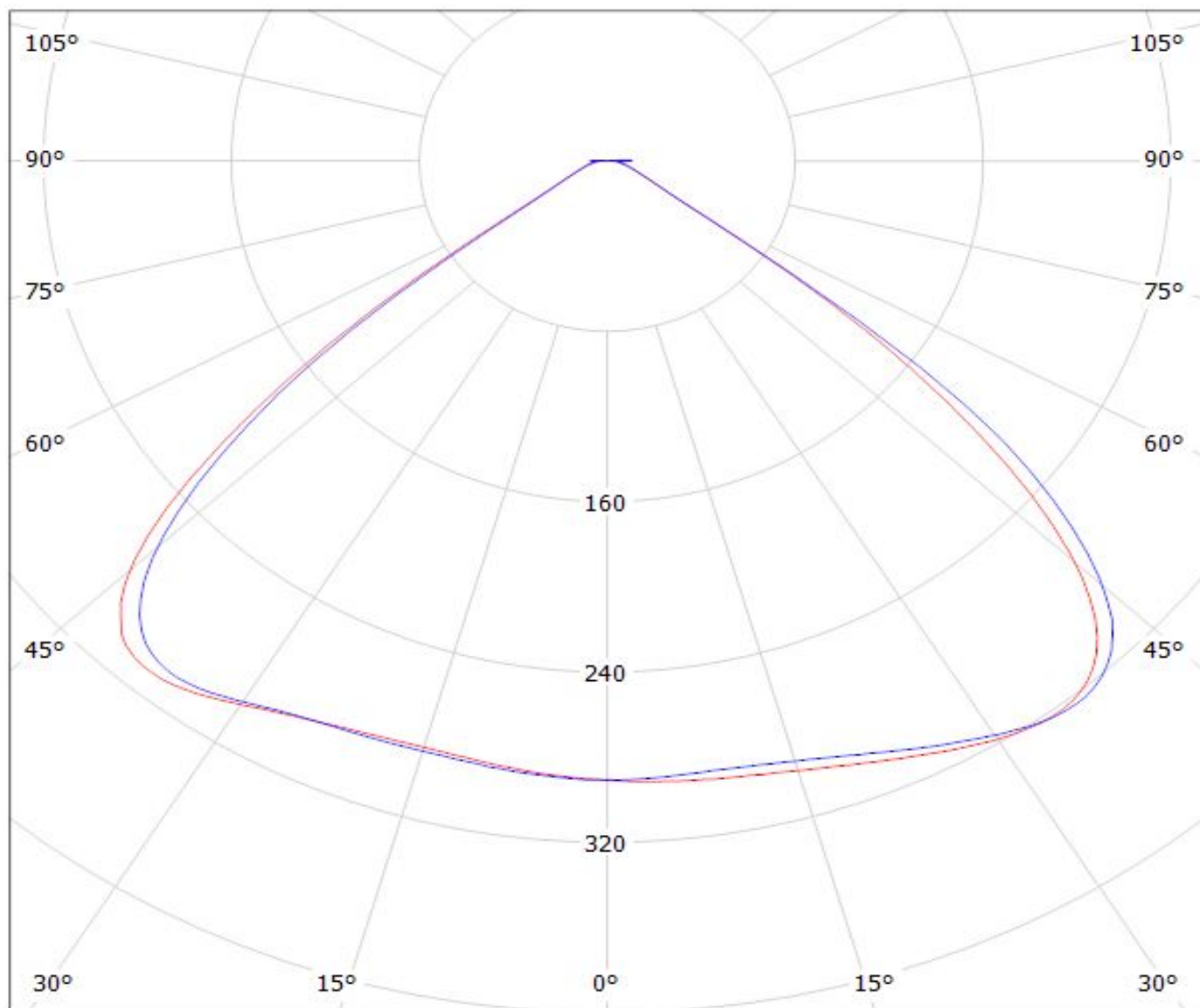

cd/klm

— C0 - C180 — C90 - C270

$\eta = 93\%$

Luminaire: LEDiL Oy F14325_JENNY-8X1-CY_(SLE-G5_LES-11)
Lamps: 1 x Tridonic_SLE-G5_LES-11_9492lm@250mA

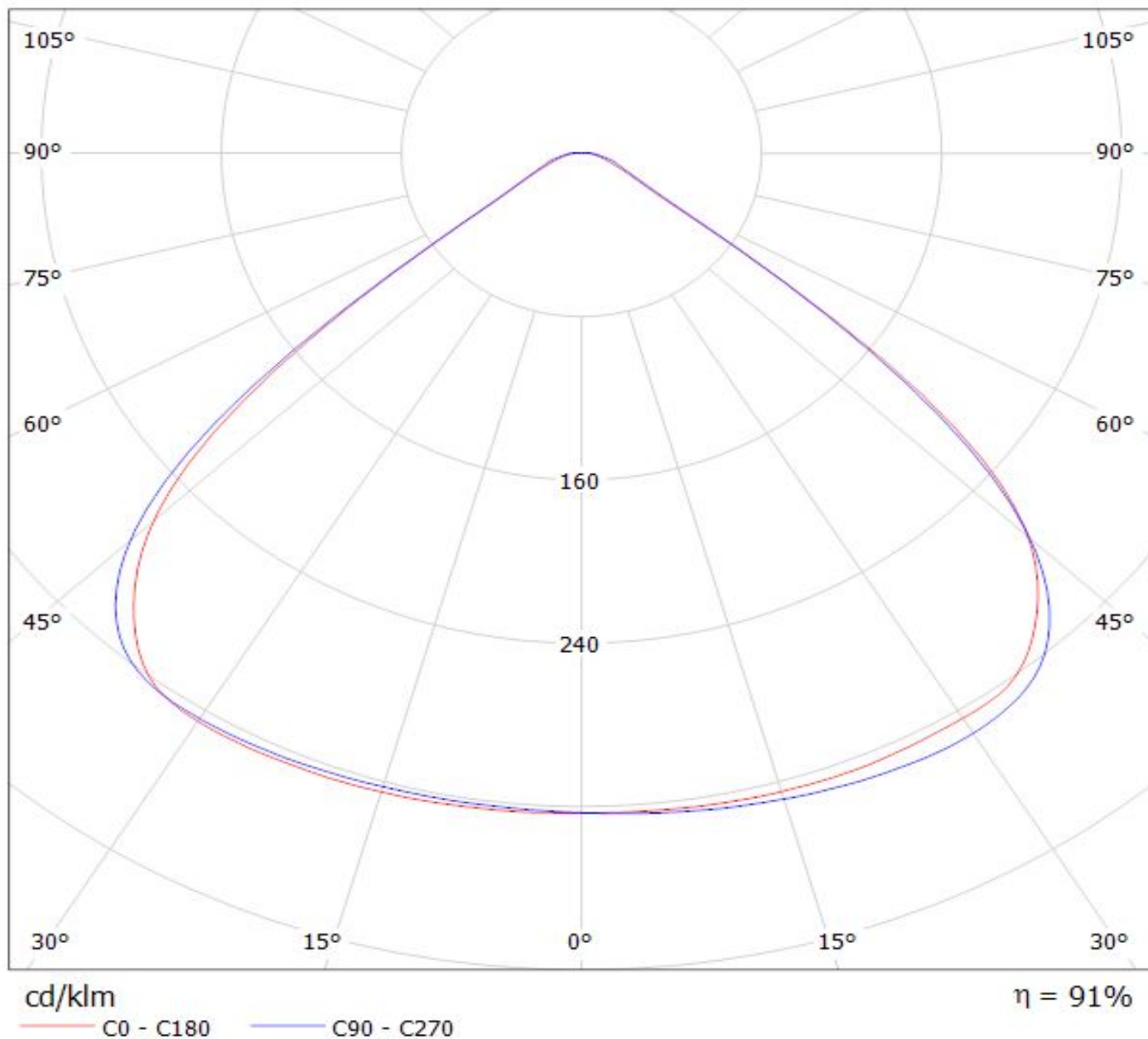

NOTE: The typical divergence will be changed by different color, chip size and chip position tolerance. The typical total divergence is the full angle measured where the luminous intensity is half of the peak value.

GENERAL INFORMATION

- Product series especially designed & optimized for series of LEDs.
- Special care taken to make light distribution as uniform as possible.

Note! Due to use of high power COB's with this product, special attention to proper thermal design is highly recommended. LEDiL has no liability for direct, indirect or consecutive damages arising from the LEDiL products being used outside of the recommended temperature range.