

RECOMMENDED P.C.B HOLE LAYOUT

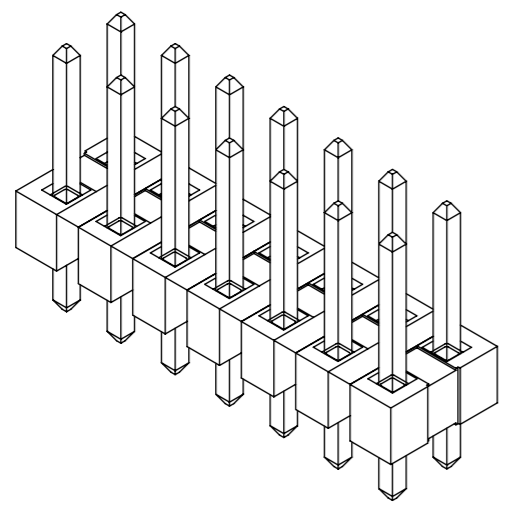
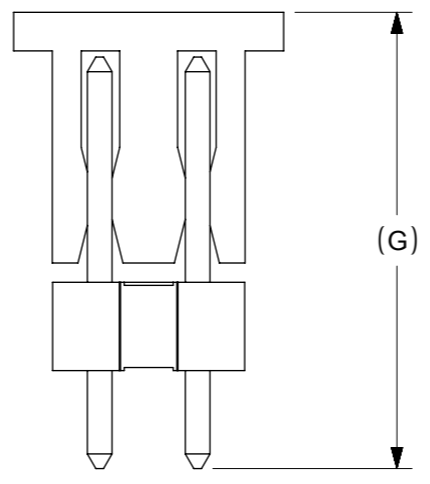
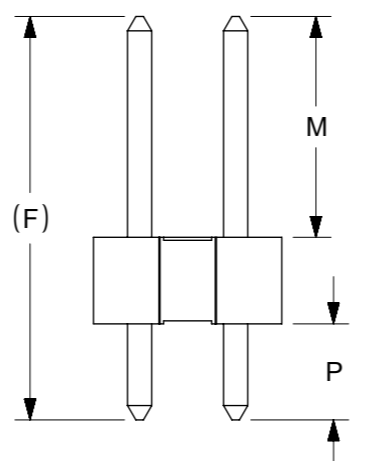
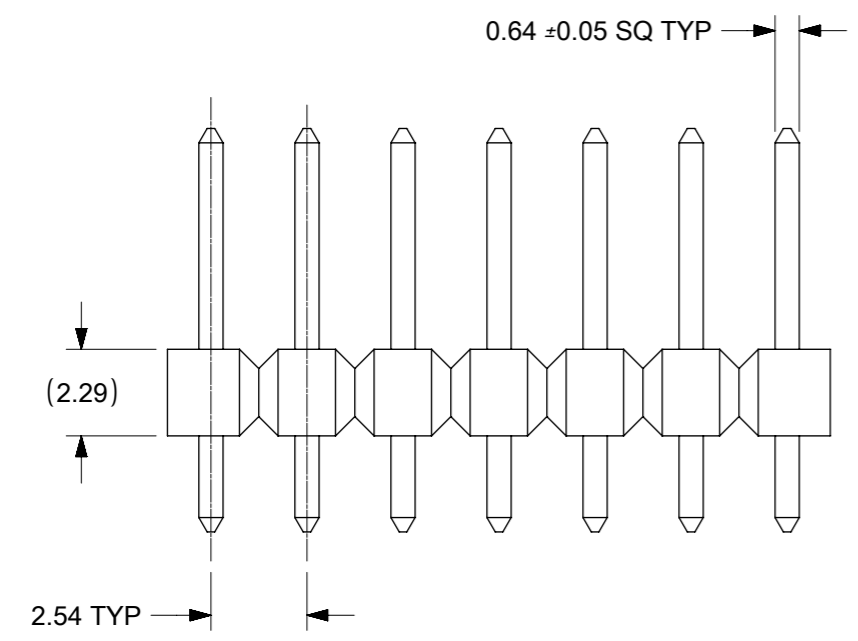

- NOTES:
- MATERIAL:
HSG: LCP, GLASS-FILLED, UL94V-0,
COLOR: BLACK
PIN: 0.64MM SQ PIN, COPPER ALLOY
 - PLATING TYPE:
 - 0.0254 μ m GOLD FLASH OVER
1.25 μ m MIN. NICKEL OVERALL.
 - 0.025 μ m MIN. GOLD PLATE ON CONTACT AND
1.88 μ m MIN. TIN ON SOLDER TAIL OVER
1.25 μ m MIN. NICKEL OVERALL.
 - 0.25 μ m MIN. GOLD PLATE ON CONTACT AND
1.88 μ m MIN. TIN ON SOLDER TAIL OVER
1.25 μ m MIN. NICKEL OVERALL.
 - 0.38 μ m MIN. GOLD PLATE ON CONTACT AND
1.88 μ m MIN. TIN ON SOLDER TAIL OVER
1.25 μ m MIN. NICKEL OVERALL.
 - 0.75 μ m MIN. GOLD PLATE ON CONTACT AND
1.88 μ m MIN. TIN ON SOLDER TAIL OVER
1.25 μ m MIN. NICKEL OVERALL.
 - 2.50 μ m MIN. TIN OVER 1.25 m MIN. NICKEL OVERALL.
 - 0.38 μ m MIN. GOLD PLATE ON CONTACT AND
2.50 μ m MIN. TIN ON SOLDER TAIL OVER
1.25 μ m MIN. NICKEL OVERALL.
 - 0.38 μ m MIN. GOLD PLATE ON CONTACT AND
0.05 μ m MIN. GOLD FLASH ON SOLDER TAIL OVER
1.25 μ m MIN. NICKEL OVERALL.
 - 0.05 - 0.25 μ m MIN. GOLD FLASH OVER
1.25 μ m MIN. NICKEL OVERALL.
 - PIN PUSHOUT FORCE: 1KG MIN IN EITHER DIRECTION
 - THE ABOVE 14 CKT IS FOR ILLUSTRATION PURPOSE ONLY.
 - FOR PACKAGING OPTION PLEASE REFER TO THE TABLE.
 - RECOMMENDED PCB THICKNESS 1.60MM.
 - PRODUCT SPECIFICATION: PS-87920-019
 - WAFER TO BE FLAT WITHIN 0.003mm/mm
 - IRREGULAR CIRCUIT CUTOFF WITHIN BREAKAWAY SECTION IS PERMISSIBLE. CUTTING OR CHIPPING OF THE MAIN BODY IS NOT ACCEPTABLE.
 - PARTS ARE NOT STACKABLE ON 2.54 CENTER
 - CAP TO BE PLACED AS CENTRAL OF PART AS POSSIBLE WITH THE TOP SURFACE FLAT FOR PICK AND PLACE.
 - PACKAGING SPECIFICATION:
TRAY: PK-89990-489
BULK: PK-89990-491
TUBE: PK-87914-300

REVISION OF DRAWING MAY BE CHANGED DURING FINAL RELEASED FOR PRODUCTION.

RELEASE STATUS	RELEASE DATE
----------------	--------------

THIS DRAWING CONTAINS INFORMATION THAT IS PROPRIETARY TO MOLEX ELECTRONIC TECHNOLOGIES, LLC AND SHOULD NOT BE USED WITHOUT WRITTEN PERMISSION									
MIGRATED TO NX EC NO: 114466 DRWN: PKH CHK'D: REV APPR: ISHWARG	GENERAL TOLERANCES (UNLESS SPECIFIED)		DIMENSION UNITS		SCALE				
			MM	INCH	MM	NTS			
	4 PLACES	±	±	DRWN BY	DATE		2.54MM PITCH DUAL ROW HEADER SINGLE WAFER, T/H		
	3 PLACES	±	±	KCHO	2004/11/05				
	2 PLACES	± 0.2	±	CHK'D BY	DATE		PRODUCT CUSTOMER DRAWING		
1 PLACES	±	±	PTLIM	2004/12/08					
0 PLACES	±	±	APPR BY	DATE		SERIES: 87914 MATERIAL NUMBER: SEE TABLE CUSTOMER: GENERAL MARKET			
			MLONG	2010/09/06					
	ANGULAR TOL = 3.0		DRAWING SIZE	THIRD ANGLE PROJECTION		DOCUMENT NUMBER: SD-87914-013 DOC TYPE: PSD DOC PART: 000 SHEET NUMBER: 1 OF 45			
D17			A3						
	DRAFT WHERE APPLICABLE MUST REMAIN WITHIN DIMENSIONS								

PART NO FOR TRAY PACKAGING	PART NO. FOR TUBE WITHOUT CAP PACKAGING	PART NO. FOR TUBE WITH CAP PACKAGING	PART NO. FOR TAPE & REEL WITHOUT CAP PACKAGING	PART NO. FOR TAPE & REEL WITH CAP PACKAGING	CKT SIZE	VOID POSITION	PLATING TYPE	DIMENSION				
								A	B	F	M	P
87914-0211	-----	-----	-----	-----	2	-----	1	2.54	----	10.92	5.84	2.79
87914-0221	-----	-----	-----	-----	2	-----	1	2.54	----	12.25	7.00	2.96
87914-0231	-----	-----	-----	-----	2	-----	1	2.54	----	13.38	6.09	5.00
87914-0212	-----	-----	-----	-----	2	-----	2	2.54	----	10.92	5.84	2.79
87914-0222	-----	-----	-----	-----	2	-----	2	2.54	----	12.25	7.00	2.96
87914-0232	-----	-----	-----	-----	2	-----	2	2.54	----	13.38	6.09	5.00
87914-0213	-----	-----	-----	-----	2	-----	3	2.54	----	10.92	5.84	2.79
87914-0223	-----	-----	-----	-----	2	-----	3	2.54	----	12.25	7.00	2.96
87914-0233	-----	-----	-----	-----	2	-----	3	2.54	----	13.38	6.09	5.00
87914-0214	-----	-----	-----	-----	2	-----	4	2.54	----	10.92	5.84	2.79
87914-0224	-----	-----	-----	-----	2	-----	4	2.54	----	12.25	7.00	2.96
87914-0234	-----	-----	-----	-----	2	-----	4	2.54	----	13.38	6.09	5.00
87914-0215	-----	-----	-----	-----	2	-----	5	2.54	----	10.92	5.84	2.79
87914-0225	-----	-----	-----	-----	2	-----	5	2.54	----	12.25	7.00	2.96
87914-0235	-----	-----	-----	-----	2	-----	5	2.54	----	13.38	6.09	5.00
87914-0216	-----	-----	-----	-----	2	-----	6	2.54	----	10.92	5.84	2.79
87914-0226	-----	-----	-----	-----	2	-----	6	2.54	----	12.25	7.00	2.96
87914-0236	-----	-----	-----	-----	2	-----	6	2.54	----	13.38	6.09	5.00

THIS DRAWING CONTAINS INFORMATION THAT IS PROPRIETARY TO MOLEX ELECTRONIC TECHNOLOGIES, LLC AND SHOULD NOT BE USED WITHOUT WRITTEN PERMISSION

MIGRATED TO NX 2017/01/18 EC NO: 114466 DRWN: PKH CHK'D: REV	2017/03/15 APPR: ISHWARG	GENERAL TOLERANCES (UNLESS SPECIFIED)		DIMENSION UNITS		SCALE		
				MM		NTS		
				MM	INCH	DRWN BY	DATE	
		4 PLACES	±	±		KCHO	2004/11/05	
		3 PLACES	±	±		CHK'D BY	DATE	
		2 PLACES	± 0.2	±		PTLIM	2004/12/08	
1 PLACES	±	±		APPR BY	DATE			
0 PLACES	±	±		MLONG	2010/09/06			
ANGULAR TOL = 3.0				DRAWING SIZE	THIRD ANGLE PROJECTION			
DRAFT WHERE APPLICABLE MUST REMAIN WITHIN DIMENSIONS				A3				

2.54MM PITCH
DUAL ROW HEADER SINGLE WAFER, T/H

PRODUCT CUSTOMER DRAWING

SERIES	MATERIAL NUMBER	CUSTOMER	
87914	SEE TABLE	GENERAL MARKET	
DOCUMENT NUMBER	DOC TYPE	DOC PART	SHEET NUMBER
SD-87914-013	PSD	000	2 OF 45

RELEASE STATUS	RELEASE DATE
----------------	--------------

PART NO FOR TRAY PACKAGING	PART NO. FOR TUBE WITHOUT CAP PACKAGING	PART NO. FOR TUBE WITH CAP PACKAGING	PART NO. FOR TAPE & REEL WITHOUT CAP PACKAGING	PART NO. FOR TAPE & REEL WITH CAP PACKAGING	CKT SIZE	VOID POSITION	PLATING TYPE	DIMENSION				
								A	B	F	M	P
87914-0411	-----	-----	-----	-----	4	-----	1	5.08	2.54	10.92	5.84	2.79
87914-0421	-----	-----	-----	-----	4	-----	1	5.08	2.54	12.25	7.00	2.96
87914-0431	-----	-----	-----	-----	4	-----	1	5.08	2.54	13.38	6.09	5.00
87914-0412	-----	-----	-----	-----	4	-----	2	5.08	2.54	10.92	5.84	2.79
87914-0422	-----	-----	-----	-----	4	-----	2	5.08	2.54	12.25	7.00	2.96
87914-0432	-----	-----	-----	-----	4	-----	2	5.08	2.54	13.38	6.09	5.00
87914-0413	-----	-----	-----	-----	4	-----	3	5.08	2.54	10.92	5.84	2.79
87914-0423	-----	-----	-----	-----	4	-----	3	5.08	2.54	12.25	7.00	2.96
87914-0433	-----	-----	-----	-----	4	-----	3	5.08	2.54	13.38	6.09	5.00
87914-0414	-----	-----	-----	-----	4	-----	4	5.08	2.54	10.92	5.84	2.79
87914-0424	-----	-----	-----	-----	4	-----	4	5.08	2.54	12.25	7.00	2.96
87914-0434	-----	-----	-----	-----	4	-----	4	5.08	2.54	13.38	6.09	5.00
87914-0415	-----	-----	-----	-----	4	-----	5	5.08	2.54	10.92	5.84	2.79
87914-0425	-----	-----	-----	-----	4	-----	5	5.08	2.54	12.25	7.00	2.96
87914-0435	-----	-----	-----	-----	4	-----	5	5.08	2.54	13.38	6.09	5.00
87914-0416	-----	-----	-----	-----	4	-----	6	5.08	2.54	10.92	5.84	2.79
87914-0426	-----	-----	-----	-----	4	-----	6	5.08	2.54	12.25	7.00	2.96
87914-0436	-----	-----	-----	-----	4	-----	6	5.08	2.54	13.38	6.09	5.00

THIS DRAWING CONTAINS INFORMATION THAT IS PROPRIETARY TO MOLEX ELECTRONIC TECHNOLOGIES, LLC AND SHOULD NOT BE USED WITHOUT WRITTEN PERMISSION

MIGRATED TO NX EC NO: 114466 DRWN: PKH CHK'D: REV APPR: ISHWARG	GENERAL TOLERANCES (UNLESS SPECIFIED)		DIMENSION UNITS		SCALE	
			MM	INCH	MM	NTS
	4 PLACES	±			DRWN BY	DATE
	3 PLACES	±			KCHO	2004/11/05
	2 PLACES	± 0.2			CHK'D BY	DATE
	1 PLACES	±			PTLIM	2004/12/08
0 PLACES	±			APPR BY	DATE	
				MLONG	2010/09/06	
ANGULAR TOL = 3.0			DRAWING SIZE	THIRD ANGLE PROJECTION		
DRAFT WHERE APPLICABLE MUST REMAIN WITHIN DIMENSIONS			A3			

2.54MM PITCH
DUAL ROW HEADER SINGLE WAFER, T/H

PRODUCT CUSTOMER DRAWING

SERIES	MATERIAL NUMBER	CUSTOMER
87914	SEE TABLE	GENERAL MARKET
DOCUMENT NUMBER	DOC TYPE	DOC PART
SD-87914-013	PSD	000
SHEET NUMBER		
3 OF 45		

RELEASE STATUS	RELEASE DATE
----------------	--------------

PART NO FOR TRAY PACKAGING	PART NO. FOR TUBE WITHOUT CAP PACKAGING	PART NO. FOR TUBE WITH CAP PACKAGING	PART NO. FOR TAPE & REEL WITHOUT CAP PACKAGING	PART NO. FOR TAPE & REEL WITH CAP PACKAGING	CKT SIZE	VOID POSITION	PLATING TYPE	DIMENSION					
								A	B	F	M	P	G
87914-0611	-----	-----	-----	-----	6	-----	1	7.62	5.08	10.92	5.84	2.79	----
87914-0621	-----	-----	-----	-----	6	-----	1	7.62	5.08	12.25	7.00	2.96	----
87914-0631	-----	-----	-----	-----	6	-----	1	7.62	5.08	13.38	6.09	5.00	----
87914-0612	-----	-----	-----	-----	6	-----	2	7.62	5.08	10.92	5.84	2.79	----
87914-0622	-----	-----	-----	-----	6	-----	2	7.62	5.08	12.25	7.00	2.96	----
87914-0632	-----	-----	-----	-----	6	-----	2	7.62	5.08	13.38	6.09	5.00	----
87914-0613	-----	-----	-----	-----	6	-----	3	7.62	5.08	10.92	5.84	2.79	----
87914-0623	-----	-----	-----	-----	6	-----	3	7.62	5.08	12.25	7.00	2.96	----
87914-0633	-----	-----	-----	-----	6	-----	3	7.62	5.08	13.38	6.09	5.00	----
87914-0614	-----	-----	-----	-----	6	-----	4	7.62	5.08	10.92	5.84	2.79	----
87914-0624	-----	-----	-----	-----	6	-----	4	7.62	5.08	12.25	7.00	2.96	----
87914-0634	-----	-----	-----	-----	6	-----	4	7.62	5.08	13.38	6.09	5.00	----
87914-0615	-----	-----	-----	-----	6	-----	5	7.62	5.08	10.92	5.84	2.79	----
87914-0625	-----	-----	-----	-----	6	-----	5	7.62	5.08	12.25	7.00	2.96	----
87914-0635	-----	-----	-----	-----	6	-----	5	7.62	5.08	13.38	6.09	5.00	----
87914-0616	-----	-----	-----	-----	6	-----	6	7.62	5.08	10.92	5.84	2.79	----
87914-0626	-----	-----	-----	-----	6	-----	6	7.62	5.08	12.25	7.00	2.96	----
87914-0636	-----	-----	-----	-----	6	-----	6	7.62	5.08	13.38	6.09	5.00	----

THIS DRAWING CONTAINS INFORMATION THAT IS PROPRIETARY TO MOLEX ELECTRONIC TECHNOLOGIES, LLC AND SHOULD NOT BE USED WITHOUT WRITTEN PERMISSION

MIGRATED TO NX 2017/01/18 EC NO: 114466 DRWN: PKH CHK'D: 2017/03/15 APPR: ISHWARG	GENERAL TOLERANCES (UNLESS SPECIFIED)		DIMENSION UNITS		SCALE	
			MM	INCH	MM	NTS
	4 PLACES	±			DRWN BY	DATE
	3 PLACES	±			KCHO	2004/11/05
	2 PLACES	± 0.2			CHK'D BY	DATE
	1 PLACES	±			PTLIM	2004/12/08
	0 PLACES	±			APPR BY	DATE
					MLONG	2010/09/06
	ANGULAR TOL = 3.0			DRAWING SIZE	THIRD ANGLE PROJECTION	
	DRAFT WHERE APPLICABLE MUST REMAIN WITHIN DIMENSIONS			A3		

molex [®]		
2.54MM PITCH DUAL ROW HEADER SINGLE WAFER, T/H		
PRODUCT CUSTOMER DRAWING		
SERIES	MATERIAL NUMBER	CUSTOMER
87914	SEE TABLE	GENERAL MARKET
DOCUMENT NUMBER	DOC TYPE	DOC PART SHEET NUMBER
SD-87914-013	PSD	000 4 OF 45

RELEASE STATUS	RELEASE DATE

PART NO FOR TRAY PACKAGING	PART NO. FOR TUBE WITHOUT CAP PACKAGING	PART NO. FOR TUBE WITH CAP PACKAGING	PART NO. FOR TAPE & REEL WITHOUT CAP PACKAGING	PART NO. FOR TAPE & REEL WITH CAP PACKAGING	CKT SIZE	VOID POSITION	PLATING TYPE	DIMENSION				
								A	B	F	M	P
87914-0009	-----	-----	-----	-----	6	-----	1	7.62	5.08	18.84	13.25	3.30
87914-0642	-----	-----	-----	-----	6	-----	2	7.62	5.08	18.84	13.25	3.30
87914-0643	-----	-----	-----	-----	6	-----	3	7.62	5.08	18.84	13.25	3.30
87914-0644	-----	-----	-----	-----	6	-----	4	7.62	5.08	18.84	13.25	3.30
87914-0645	-----	-----	-----	-----	6	-----	5	7.62	5.08	18.84	13.25	3.30
87914-0646	-----	-----	-----	-----	6	-----	6	7.62	5.08	18.84	13.25	3.30

THIS DRAWING CONTAINS INFORMATION THAT IS PROPRIETARY TO MOLEX ELECTRONIC TECHNOLOGIES, LLC AND SHOULD NOT BE USED WITHOUT WRITTEN PERMISSION

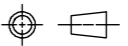
MIGRATED TO NX 2017/01/18 EC NO: 114466 DRWN: PKH CHK'D: ISHWARG	GENERAL TOLERANCES (UNLESS SPECIFIED)		DIMENSION UNITS		SCALE														
	4 PLACES	±	MM	INCH	MM	NTS													
REV APPR: ISHWARG	3 PLACES	±	DRWN BY		DATE		2.54MM PITCH DUAL ROW HEADER SINGLE WAFER, T/H												
	2 PLACES	± 0.2	KCHO		2004/11/05														
	1 PLACES	±	CHK'D BY		DATE														
	0 PLACES	±	PTLIM		2004/12/08														
	ANGULAR TOL = 3.0		APPR BY		DATE														
DRAFT WHERE APPLICABLE MUST REMAIN WITHIN DIMENSIONS		MLONG		2010/09/06		PRODUCT CUSTOMER DRAWING													
A3		DRAWING SIZE		THIRD ANGLE PROJECTION		SERIES	MATERIAL NUMBER	CUSTOMER											
D17		A3				87914	SEE TABLE	GENERAL MARKET											
RELEASE STATUS						RELEASE DATE						DOCUMENT NUMBER		DOC TYPE		DOC PART		SHEET NUMBER	
												SD-87914-013		PSD		000		5 OF 45	

PART NO FOR TRAY PACKAGING	PART NO. FOR TUBE WITHOUT CAP PACKAGING	PART NO. FOR TUBE WITH CAP PACKAGING	PART NO. FOR TAPE & REEL WITHOUT CAP PACKAGING	PART NO. FOR TAPE & REEL WITH CAP PACKAGING	CKT SIZE	VOID POSITION	PLATING TYPE	DIMENSION					
								A	B	F	M	P	G
87914-0811	-----	-----	-----	-----	8	-----	1	10.16	7.62	10.92	5.84	2.79	----
87914-0821	-----	-----	-----	-----	8	-----	1	10.16	7.62	12.25	7.00	2.96	----
87914-0831	-----	-----	-----	-----	8	-----	1	10.16	7.62	13.38	6.09	5.00	----
87914-0812	-----	-----	-----	-----	8	-----	2	10.16	7.62	10.92	5.84	2.79	----
87914-0822	-----	-----	-----	-----	8	-----	2	10.16	7.62	12.25	7.00	2.96	----
87914-0832	-----	-----	-----	-----	8	-----	2	10.16	7.62	13.38	6.09	5.00	----
87914-0813	-----	-----	-----	-----	8	-----	3	10.16	7.62	10.92	5.84	2.79	----
87914-0823	-----	-----	-----	-----	8	-----	3	10.16	7.62	12.25	7.00	2.96	----
87914-0833	-----	-----	-----	-----	8	-----	4	10.16	7.62	13.38	6.09	5.00	----
87914-0814	-----	-----	-----	-----	8	-----	4	10.16	7.62	10.92	5.84	2.79	----
87914-0824	-----	-----	-----	-----	8	-----	4	10.16	7.62	12.25	7.00	2.96	----
87914-0834	-----	-----	-----	-----	8	-----	4	10.16	7.62	13.38	6.09	5.00	----
87914-0815	-----	-----	-----	-----	8	-----	5	10.16	7.62	10.92	5.84	2.79	----
87914-0825	-----	-----	-----	-----	8	-----	5	10.16	7.62	12.25	7.00	2.96	----
87914-0835	-----	-----	-----	-----	8	-----	5	10.16	7.62	13.38	6.09	5.00	----
87914-0816	-----	-----	-----	-----	8	-----	6	10.16	7.62	10.92	5.84	2.79	----
87914-0826	-----	-----	-----	-----	8	-----	6	10.16	7.62	12.25	7.00	2.96	----
87914-0836	-----	-----	-----	-----	8	-----	6	10.16	7.62	13.38	6.09	5.00	----
87914-0807	-----	-----	-----	-----	8	2,3,4,5,6,8	6	10.16	7.62	21.75	16.51	2.95	----

THIS DRAWING CONTAINS INFORMATION THAT IS PROPRIETARY TO MOLEX ELECTRONIC TECHNOLOGIES, LLC AND SHOULD NOT BE USED WITHOUT WRITTEN PERMISSION

MIGRATED TO NX 2017/01/18 EC NO: 114466 DRWN: PKH CHK'D: REV APPR: ISHWARG 2017/03/15	GENERAL TOLERANCES (UNLESS SPECIFIED)		DIMENSION UNITS		SCALE	
			MM	INCH	MM	NTS
	4 PLACES	±			DRWN BY	DATE
	3 PLACES	±			KCHO	2004/11/05
	2 PLACES	± 0.2			CHK'D BY	DATE
	1 PLACES	±			PTLIM	2004/12/08
0 PLACES	±			APPR BY	DATE	
				MLONG	2010/09/06	
ANGULAR TOL = 3.0			DRAWING SIZE	THIRD ANGLE PROJECTION		
DRAFT WHERE APPLICABLE MUST REMAIN WITHIN DIMENSIONS			A3			

2.54MM PITCH DUAL ROW HEADER SINGLE WAFER, T/H		
PRODUCT CUSTOMER DRAWING		
SERIES	MATERIAL NUMBER	CUSTOMER
87914	SEE TABLE	GENERAL MARKET
DOCUMENT NUMBER	DOC TYPE	DOC PART
SD-87914-013	PSD	000
SHEET NUMBER		
6 OF 45		

RELEASE STATUS	RELEASE DATE

PART NO FOR TRAY PACKAGING	PART NO. FOR TUBE WITHOUT CAP PACKAGING	PART NO. FOR TUBE WITH CAP PACKAGING	PART NO. FOR TAPE & REEL WITHOUT CAP PACKAGING	PART NO. FOR TAPE & REEL WITH CAP PACKAGING	CKT SIZE	VOID POSITION	PLATING TYPE	DIMENSION				
								A	B	F	M	P
87914-0841	-----	-----	-----	-----	8	-----	1	10.16	7.62	13.51	8.75	2.47
87914-0842	-----	-----	-----	-----	8	-----	2	10.16	7.62	13.51	8.75	2.47
87914-0843	-----	-----	-----	-----	8	-----	3	10.16	7.62	13.51	8.75	2.47
87914-0844	-----	-----	-----	-----	8	-----	4	10.16	7.62	13.51	8.75	2.47
87914-0845	-----	-----	-----	-----	8	-----	5	10.16	7.62	13.51	8.75	2.47
87914-0005	-----	-----	-----	-----	8	-----	6	10.16	7.62	13.51	8.75	2.47
87914-0108	-----	-----	-----	-----	8	-----	6	10.16	7.62	16.50	11.11	3.10
87914-0847	-----	-----	-----	-----	8	-----	6	10.16	7.62	26.70	20.76	3.65

RELEASE STATUS				RELEASE DATE				7	6	5	4	3	2	1
----------------	--	--	--	--------------	--	--	--	---	---	---	---	---	---	---

THIS DRAWING CONTAINS INFORMATION THAT IS PROPRIETARY TO MOLEX ELECTRONIC TECHNOLOGIES, LLC AND SHOULD NOT BE USED WITHOUT WRITTEN PERMISSION

MIGRATED TO NX 2017/01/18 EC NO: 114466 DRWN: PKH CHK'D: REV APPR: ISHWARG 2017/03/15	GENERAL TOLERANCES (UNLESS SPECIFIED)		DIMENSION UNITS		SCALE			
			MM		NTS			
			MM	INCH	DRWN BY		DATE	
	4 PLACES	±	±	KCHO		2004/11/05		
	3 PLACES	±	±	CHK'D BY		DATE		
	2 PLACES	± 0.2	±	PTLIM		2004/12/08		
	1 PLACES	±	±	APPR BY		DATE		
	0 PLACES	±	±	MLONG		2010/09/06		
	ANGULAR TOL = 3.0			DRAWING SIZE		THIRD ANGLE PROJECTION		
	DRAFT WHERE APPLICABLE MUST REMAIN WITHIN DIMENSIONS			A3				

molex [®]	
2.54MM PITCH DUAL ROW HEADER SINGLE WAFER, T/H	
PRODUCT CUSTOMER DRAWING	
SERIES	MATERIAL NUMBER
87914	SEE TABLE
CUSTOMER	
GENERAL MARKET	
DOCUMENT NUMBER	
SD-87914-013	
DOC TYPE	DOC PART
PSD	000
SHEET NUMBER	
7 OF 45	

PART NO FOR TRAY PACKAGING	PART NO. FOR TUBE WITHOUT CAP PACKAGING	PART NO. FOR TUBE WITH CAP PACKAGING	PART NO. FOR TAPE & REEL WITHOUT CAP PACKAGING	PART NO. FOR TAPE & REEL WITH CAP PACKAGING	PART NO. FOR BULK PACKAGING	CKT SIZE	VOID POSITION	PLATING TYPE	DIMENSION					
									A	B	F	M	P	G
87914-1011	-----	-----	-----	-----	-----	10	-----	1	12.70	10.16	10.92	5.84	2.79	----
87914-1021	-----	-----	-----	-----	-----	10	-----	1	12.70	10.16	12.25	7.00	2.96	----
87914-1031	-----	-----	-----	-----	-----	10	-----	1	12.70	10.16	13.38	6.09	5.00	----
87914-1012	-----	-----	-----	-----	-----	10	-----	2	12.70	10.16	10.92	5.84	2.79	----
87914-1022	-----	-----	-----	-----	-----	10	-----	2	12.70	10.16	12.25	7.00	2.96	----
87914-1032	-----	-----	-----	-----	-----	10	-----	2	12.70	10.16	13.38	6.09	5.00	----
87914-1013	-----	-----	-----	-----	-----	10	-----	3	12.70	10.16	10.92	5.84	2.79	----
87914-1023	-----	-----	-----	-----	-----	10	-----	3	12.70	10.16	12.25	7.00	2.96	----
87914-1033	-----	-----	-----	-----	-----	10	-----	3	12.70	10.16	13.38	6.09	5.00	----
87914-1014	-----	-----	-----	-----	-----	10	-----	4	12.70	10.16	10.92	5.84	2.79	----
87914-1024	-----	-----	-----	-----	-----	10	-----	4	12.70	10.16	12.25	7.00	2.96	----
87914-1034	-----	-----	-----	-----	-----	10	-----	4	12.70	10.16	13.38	6.09	5.00	----
87914-1015	-----	-----	-----	-----	-----	10	-----	5	12.70	10.16	10.92	5.84	2.79	----
87914-1025	-----	-----	-----	-----	-----	10	-----	5	12.70	10.16	12.25	7.00	2.96	----
87914-1035	-----	-----	-----	-----	-----	10	-----	5	12.70	10.16	13.38	6.09	5.00	----
87914-1016	-----	-----	-----	-----	-----	10	-----	6	12.70	10.16	10.92	5.84	2.79	----
87914-1026	-----	-----	-----	-----	-----	10	-----	6	12.70	10.16	12.25	7.00	2.96	----
87914-1036	-----	-----	-----	-----	-----	10	-----	6	12.70	10.16	13.38	6.09	5.00	----
87914-0001	-----	-----	-----	-----	-----	10	-----	7	12.70	10.16	12.07	5.97	3.81	----
-----	-----	-----	-----	-----	87914-1037	10	9	4	12.70	10.16	10.92	5.84	2.79	----

THIS DRAWING CONTAINS INFORMATION THAT IS PROPRIETARY TO MOLEX ELECTRONIC TECHNOLOGIES, LLC AND SHOULD NOT BE USED WITHOUT WRITTEN PERMISSION

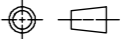
MIGRATED TO NX EC NO: 114466 DRWN: PKH CHK'D: ISHWARG REV APPR: ISHWARG	GENERAL TOLERANCES (UNLESS SPECIFIED)		DIMENSION UNITS		SCALE		 2.54MM PITCH DUAL ROW HEADER SINGLE WAFER, T/H PRODUCT CUSTOMER DRAWING				
			MM	INCH	MM	NTS					
	4 PLACES	±	±	DRWN BY		DATE					
			KCHO		2004/11/05						
	3 PLACES	±	±	CHK'D BY		DATE					
			PTLIM		2004/12/08						
2 PLACES	± 0.2	±	APPR BY		DATE						
		MLONG		2010/09/06							
1 PLACES	±	±	DRAWING SIZE		THIRD ANGLE PROJECTION						
		A3									
0 PLACES	±	±	DRAFT WHERE APPLICABLE MUST REMAIN WITHIN DIMENSIONS								
				SERIES		MATERIAL NUMBER		CUSTOMER			
				87914		SEE TABLE		GENERAL MARKET			
				DOCUMENT NUMBER		DOC TYPE		DOC PART		SHEET NUMBER	
				SD-87914-013		PSD		000		8 OF 45	

RELEASE STATUS	RELEASE DATE
----------------	--------------

PART NO FOR TRAY PACKAGING	PART NO. FOR TUBE WITHOUT CAP PACKAGING	PART NO. FOR TUBE WITH CAP PACKAGING	PART NO. FOR TAPE & REEL WITHOUT CAP PACKAGING	PART NO. FOR TAPE & REEL WITH CAP PACKAGING	CKT SIZE	VOID POSITION	PLATING TYPE	DIMENSION				
								A	B	F	M	P
87914-1211	-----	-----	-----	-----	12	-----	1	15.24	12.70	10.92	5.84	2.79
-----	87914-1291	-----	-----	-----	12	-----	9	15.24	12.70	10.92	5.84	2.79
87914-1221	-----	-----	-----	-----	12	-----	1	15.24	12.70	12.25	7.00	2.96
87914-1231	-----	-----	-----	-----	12	-----	1	15.24	12.70	13.38	6.09	5.00
87914-1212	-----	-----	-----	-----	12	-----	2	15.24	12.70	10.92	5.84	2.79
87914-1222	-----	-----	-----	-----	12	-----	2	15.24	12.70	12.25	7.00	2.96
87914-1232	-----	-----	-----	-----	12	-----	2	15.24	12.70	13.38	6.09	5.00
87914-1213	-----	-----	-----	-----	12	-----	3	15.24	12.70	10.92	5.84	2.79
87914-1223	-----	-----	-----	-----	12	-----	3	15.24	12.70	12.25	7.00	2.96
87914-1233	-----	-----	-----	-----	12	-----	3	15.24	12.70	13.38	6.09	5.00
87914-1214	-----	-----	-----	-----	12	-----	4	15.24	12.70	10.92	5.84	2.79
87914-1224	-----	-----	-----	-----	12	-----	4	15.24	12.70	12.25	7.00	2.96
87914-1234	-----	-----	-----	-----	12	-----	4	15.24	12.70	13.38	6.09	5.00
87914-1215	-----	-----	-----	-----	12	-----	5	15.24	12.70	10.92	5.84	2.79
87914-1225	-----	-----	-----	-----	12	-----	5	15.24	12.70	12.25	7.00	2.96
87914-1235	-----	-----	-----	-----	12	-----	5	15.24	12.70	13.38	6.09	5.00
87914-1216	-----	-----	-----	-----	12	-----	6	15.24	12.70	10.92	5.84	2.79
87914-1226	-----	-----	-----	-----	12	-----	6	15.24	12.70	12.25	7.00	2.96
87914-1236	-----	-----	-----	-----	12	-----	6	15.24	12.70	13.38	6.09	5.00

THIS DRAWING CONTAINS INFORMATION THAT IS PROPRIETARY TO MOLEX ELECTRONIC TECHNOLOGIES, LLC AND SHOULD NOT BE USED WITHOUT WRITTEN PERMISSION

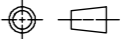
MIGRATED TO NX 2017/01/18 EC NO: 114466 DRWN: PKH CHK'D: APPR: ISHWARG 2017/03/15	GENERAL TOLERANCES (UNLESS SPECIFIED)		DIMENSION UNITS		SCALE					
			MM	INCH	MM	NTS				
	4 PLACES	±			DRWN BY	DATE	2.54MM PITCH DUAL ROW HEADER SINGLE WAFER, T/H			
	3 PLACES	±			KCHO	2004/11/05				
	2 PLACES	± 0.2			CHK'D BY	DATE				
	1 PLACES	±			PTLIM	2004/12/08	PRODUCT CUSTOMER DRAWING			
	0 PLACES	±			APPR BY	DATE				
	ANGULAR TOL = 3.0		DRAWING SIZE		THIRD ANGLE PROJECTION		SERIES	MATERIAL NUMBER	CUSTOMER	
	DRAFT WHERE APPLICABLE MUST REMAIN WITHIN DIMENSIONS		A3				87914	SEE TABLE	GENERAL MARKET	
							DOCUMENT NUMBER		DOC TYPE	DOC PART
						SD-87914-013		PSD	000	9 OF 45

RELEASE STATUS	RELEASE DATE
----------------	--------------

PART NO FOR TRAY PACKAGING	PART NO. FOR TUBE WITHOUT CAP PACKAGING	PART NO. FOR TUBE WITH CAP PACKAGING	PART NO. FOR TAPE & REEL WITHOUT CAP PACKAGING	PART NO. FOR TAPE & REEL WITH CAP PACKAGING	CKT SIZE	VOID POSITION	PLATING TYPE	DIMENSION				
								A	B	F	M	P
87914-1251	-----	-----	-----	-----	12	-----	1	15.24	12.70	18.40	13.08	3.03
87914-1252	-----	-----	-----	-----	12	-----	2	15.24	12.70	18.40	13.08	3.03
87914-1253	-----	-----	-----	-----	12	-----	3	15.24	12.70	18.40	13.08	3.03
87914-1254	-----	-----	-----	-----	12	-----	4	15.24	12.70	18.40	13.08	3.03
87914-1255	-----	-----	-----	-----	12	-----	5	15.24	12.70	18.40	13.08	3.03
87914-1256	-----	-----	-----	-----	12	-----	6	15.24	12.70	18.40	13.08	3.03
87914-1241	-----	-----	-----	-----	12	-----	1	15.24	12.70	12.50	6.95	3.26
87914-1242	-----	-----	-----	-----	12	-----	2	15.24	12.70	12.50	6.95	3.26
87914-1243	-----	-----	-----	-----	12	-----	3	15.24	12.70	12.50	6.95	3.26
87914-1244	-----	-----	-----	-----	12	-----	4	15.24	12.70	12.50	6.95	3.26
87914-1245	-----	-----	-----	-----	12	-----	5	15.24	12.70	12.50	6.95	3.26
87914-1246	-----	-----	-----	-----	12	-----	6	15.24	12.70	29.26	23.32	3.65

THIS DRAWING CONTAINS INFORMATION THAT IS PROPRIETARY TO MOLEX ELECTRONIC TECHNOLOGIES, LLC AND SHOULD NOT BE USED WITHOUT WRITTEN PERMISSION

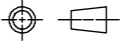
MIGRATED TO NX EC NO: 114466 DRWN: PKH CHK'D: ISHWARG APPR: ISHWARG REV:	GENERAL TOLERANCES (UNLESS SPECIFIED)		DIMENSION UNITS		SCALE											
			MM	INCH	MM	NTS										
	4 PLACES ±		DRWN BY		DATE		2.54MM PITCH DUAL ROW HEADER SINGLE WAFER, T/H									
	3 PLACES ±		KCHO		2004/11/05											
	2 PLACES ± 0.2		CHK'D BY		DATE											
	1 PLACES ±		PTLIM		2004/12/08											
	0 PLACES ±		APPR BY		DATE											
	ANGULAR TOL = 3.0		MLONG		2010/09/06		PRODUCT CUSTOMER DRAWING									
	DRAFT WHERE APPLICABLE MUST REMAIN WITHIN DIMENSIONS		DRAWING SIZE		THIRD ANGLE PROJECTION		<table border="1" style="width: 100%;"> <tr> <td>SERIES</td> <td>MATERIAL NUMBER</td> <td>CUSTOMER</td> </tr> <tr> <td>87914</td> <td>SEE TABLE</td> <td>GENERAL MARKET</td> </tr> </table>			SERIES	MATERIAL NUMBER	CUSTOMER	87914	SEE TABLE	GENERAL MARKET	
	SERIES	MATERIAL NUMBER	CUSTOMER													
87914	SEE TABLE	GENERAL MARKET														
		A3				<table border="1" style="width: 100%;"> <tr> <td>DOCUMENT NUMBER</td> <td>DOC TYPE</td> <td>DOC PART</td> <td>SHEET NUMBER</td> </tr> <tr> <td>SD-87914-013</td> <td>PSD</td> <td>000</td> <td>10 OF 45</td> </tr> </table>			DOCUMENT NUMBER	DOC TYPE	DOC PART	SHEET NUMBER	SD-87914-013	PSD	000	10 OF 45
DOCUMENT NUMBER	DOC TYPE	DOC PART	SHEET NUMBER													
SD-87914-013	PSD	000	10 OF 45													

RELEASE STATUS	RELEASE DATE
----------------	--------------

PART NO FOR TRAY PACKAGING	PART NO. FOR TUBE WITHOUT CAP PACKAGING	PART NO. FOR TUBE WITH CAP PACKAGING	PART NO. FOR TAPE & REEL WITHOUT CAP PACKAGING	PART NO. FOR TAPE & REEL WITH CAP PACKAGING	CKT SIZE	VOID POSITION	PLATING TYPE	DIMENSION				
								A	B	F	M	P
87914-1411	-----	-----	-----	-----	14	-----	1	17.78	15.24	10.92	5.84	2.79
87914-1421	-----	-----	-----	-----	14	-----	1	17.78	15.24	12.25	7.00	2.96
87914-1431	-----	-----	-----	-----	14	-----	1	17.78	15.24	13.38	6.09	5.00
87914-1412	-----	-----	-----	-----	14	-----	2	17.78	15.24	10.92	5.84	2.79
87914-1422	-----	-----	-----	-----	14	-----	2	17.78	15.24	12.25	7.00	2.96
87914-1432	-----	-----	-----	-----	14	-----	2	17.78	15.24	13.38	6.09	5.00
87914-1413	-----	-----	-----	-----	14	-----	3	17.78	15.24	10.92	5.84	2.79
87914-1423	-----	-----	-----	-----	14	-----	3	17.78	15.24	12.25	7.00	2.96
87914-1433	-----	-----	-----	-----	14	-----	3	17.78	15.24	13.38	6.09	5.00
87914-1414	-----	-----	-----	-----	14	-----	4	17.78	15.24	10.92	5.84	2.79
87914-1424	-----	-----	-----	-----	14	-----	4	17.78	15.24	12.25	7.00	2.96
87914-1434	-----	-----	-----	-----	14	-----	4	17.78	15.24	13.38	6.09	5.00
87914-1415	-----	-----	-----	-----	14	-----	5	17.78	15.24	10.92	5.84	2.79
87914-1425	-----	-----	-----	-----	14	-----	5	17.78	15.24	12.25	7.00	2.96
87914-1435	-----	-----	-----	-----	14	-----	5	17.78	15.24	13.38	6.09	5.00
87914-1416	-----	-----	-----	-----	14	-----	6	17.78	15.24	10.92	5.84	2.79
87914-1426	-----	-----	-----	-----	14	-----	6	17.78	15.24	12.25	7.00	2.96
87914-1436	-----	-----	-----	-----	14	-----	6	17.78	15.24	13.38	6.09	5.00
87914-0007	-----	-----	-----	-----	14	-----	6	17.78	15.24	13.42	8.08	3.05

THIS DRAWING CONTAINS INFORMATION THAT IS PROPRIETARY TO MOLEX ELECTRONIC TECHNOLOGIES, LLC AND SHOULD NOT BE USED WITHOUT WRITTEN PERMISSION

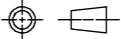
MIGRATED TO NX 2017/01/18 EC NO: 114466 DRWN: PKH CHK'D: 2017/03/15 APPR: ISHWARG	GENERAL TOLERANCES (UNLESS SPECIFIED)		DIMENSION UNITS		SCALE			
			MM	INCH	MM	NTS		
	4 PLACES	±	±	DRWN BY	DATE			2.54MM PITCH DUAL ROW HEADER SINGLE WAFER, T/H
	3 PLACES	±	±	KCHO	2004/11/05			
	2 PLACES	± 0.2	±	CHK'D BY	DATE			
	1 PLACES	±	±	PTLIM	2004/12/08			
	0 PLACES	±	±	APPR BY	DATE			
	ANGULAR TOL = 3.0			MLONG	2010/09/06			PRODUCT CUSTOMER DRAWING
	DRAFT WHERE APPLICABLE MUST REMAIN WITHIN DIMENSIONS			DRAWING SIZE	THIRD ANGLE PROJECTION			SERIES
				A3				MATERIAL NUMBER
						CUSTOMER		
						87914		
						SEE TABLE		
						GENERAL MARKET		
						DOCUMENT NUMBER		
						SD-87914-013		
						DOC TYPE		
						PSD		
						DOC PART		
						000		
						SHEET NUMBER		
						11 OF 45		

RELEASE STATUS	RELEASE DATE
----------------	--------------

PART NO FOR TRAY PACKAGING	PART NO. FOR TUBE WITHOUT CAP PACKAGING	PART NO. FOR TUBE WITH CAP PACKAGING	PART NO. FOR TAPE & REEL WITHOUT CAP PACKAGING	PART NO. FOR TAPE & REEL WITH CAP PACKAGING	CKT SIZE	VOID POSITION	PLATING TYPE	DIMENSION				
								A	B	F	M	P
87914-1441	-----	-----	-----	-----	14	-----	1	17.78	15.24	13.42	8.08	3.05
87914-1442	-----	-----	-----	-----	14	-----	2	17.78	15.24	13.42	8.08	3.05
87914-1443	-----	-----	-----	-----	14	-----	3	17.78	15.24	13.42	8.08	3.05
87914-1444	-----	-----	-----	-----	14	-----	4	17.78	15.24	13.42	8.08	3.05
87914-1445	-----	-----	-----	-----	14	-----	5	17.78	15.24	13.42	8.08	3.05

THIS DRAWING CONTAINS INFORMATION THAT IS PROPRIETARY TO MOLEX ELECTRONIC TECHNOLOGIES, LLC AND SHOULD NOT BE USED WITHOUT WRITTEN PERMISSION

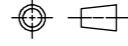
MIGRATED TO NX 2017/01/18 EC NO: 114466 DRWN: PKH CHKD: ISHWARG APPR: ISHWARG	GENERAL TOLERANCES (UNLESS SPECIFIED)		DIMENSION UNITS	SCALE	<h1>molex®</h1>				
			MM	NTS					
			MM	INCH	DRWN BY	DATE		2.54MM PITCH DUAL ROW HEADER SINGLE WAFER, T/H	
	4 PLACES	±	±	KCHO	2004/11/05				
	3 PLACES	±	±	CHK'D BY	DATE				
	2 PLACES	± 0.2	±	PTLIM	2004/12/08				
	1 PLACES	±	±	APPR BY	DATE				
	0 PLACES	±	±	MLONG	2010/09/06		PRODUCT CUSTOMER DRAWING		
	ANGULAR TOL = 3.0		DRAWING SIZE	THIRD ANGLE PROJECTION		SERIES	MATERIAL NUMBER	CUSTOMER	
	DRAFT WHERE APPLICABLE MUST REMAIN WITHIN DIMENSIONS		A3			87914	SEE TABLE	GENERAL MARKET	
				DOCUMENT NUMBER		DOC TYPE	DOC PART	SHEET NUMBER	
				SD-87914-013		PSD	000	12 OF 45	

RELEASE STATUS	RELEASE DATE
----------------	--------------

PART NO FOR TRAY PACKAGING	PART NO. FOR TUBE WITHOUT CAP PACKAGING	PART NO. FOR TUBE WITH CAP PACKAGING	PART NO. FOR TAPE & REEL WITHOUT CAP PACKAGING	PART NO. FOR TAPE & REEL WITH CAP PACKAGING	CKT SIZE	VOID POSITION	PLATING TYPE	DIMENSION				
								A	B	F	M	P
87914-1611	-----	-----	-----	-----	16	-----	1	20.32	17.78	10.92	5.84	2.79
87914-1621	-----	-----	-----	-----	16	-----	1	20.32	17.78	12.25	7.00	2.96
87914-1631	-----	-----	-----	-----	16	-----	1	20.32	17.78	13.38	6.09	5.00
87914-1612	-----	-----	-----	-----	16	-----	2	20.32	17.78	10.92	5.84	2.79
87914-1622	-----	-----	-----	-----	16	-----	2	20.32	17.78	12.25	7.00	2.96
87914-1632	-----	-----	-----	-----	16	-----	2	20.32	17.78	13.38	6.09	5.00
87914-1613	-----	-----	-----	-----	16	-----	3	20.32	17.78	10.92	5.84	2.79
87914-1623	-----	-----	-----	-----	16	-----	3	20.32	17.78	12.25	7.00	2.96
87914-1633	-----	-----	-----	-----	16	-----	3	20.32	17.78	13.38	6.09	5.00
87914-1614	-----	-----	-----	-----	16	-----	4	20.32	17.78	10.92	5.84	2.79
87914-1624	-----	-----	-----	-----	16	-----	4	20.32	17.78	12.25	7.00	2.96
87914-1634	-----	-----	-----	-----	16	-----	4	20.32	17.78	13.38	6.09	5.00
87914-1615	-----	-----	-----	-----	16	-----	5	20.32	17.78	10.92	5.84	2.79
87914-1625	-----	-----	-----	-----	16	-----	5	20.32	17.78	12.25	7.00	2.96
87914-1635	-----	-----	-----	-----	16	-----	5	20.32	17.78	13.38	6.09	5.00
87914-1616	-----	-----	-----	-----	16	-----	6	20.32	17.78	10.92	5.84	2.79
87914-1626	-----	-----	-----	-----	16	-----	6	20.32	17.78	12.25	7.00	2.96
87914-1636	-----	-----	-----	-----	16	-----	6	20.32	17.78	13.38	6.09	5.00
87914-1600	-----	-----	-----	-----	16	-----	6	20.32	17.78	9.49	4.50	2.70
87914-1637	-----	-----	-----	-----	16	-----	6	20.32	17.78	15.79	10.45	3.05

THIS DRAWING CONTAINS INFORMATION THAT IS PROPRIETARY TO MOLEX ELECTRONIC TECHNOLOGIES, LLC AND SHOULD NOT BE USED WITHOUT WRITTEN PERMISSION

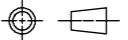
MIGRATED TO NX EC NO: 114466 DRWN: PKH CHK'D: ISHWARG APPR: ISHWARG REV:	2017/01/18	GENERAL TOLERANCES (UNLESS SPECIFIED)		DIMENSION UNITS		SCALE						
	2017/03/15	MM	INCH	MM	NTS							
	4 PLACES	±	±	DRWN BY	DATE	2.54MM PITCH DUAL ROW HEADER SINGLE WAFER, T/H						
	3 PLACES	±	±	KCHO	2004/11/05							
	2 PLACES	± 0.2	±	CHK'D BY	DATE							
	1 PLACES	±	±	PTLIM	2004/12/08							
	0 PLACES	±	±	APPR BY	DATE	PRODUCT CUSTOMER DRAWING						
				MLONG	2010/09/06							
	ANGULAR TOL = 3.0			DRAWING SIZE	THIRD ANGLE PROJECTION	SERIES	MATERIAL NUMBER	CUSTOMER				
	DRAFT WHERE APPLICABLE MUST REMAIN WITHIN DIMENSIONS			A3		87914	SEE TABLE	GENERAL MARKET				
					DOCUMENT NUMBER	DOC TYPE	DOC PART	SHEET NUMBER				
					D17	SD-87914-013	PSD	000	13 OF 45			

RELEASE STATUS	RELEASE DATE
----------------	--------------

PART NO FOR TRAY PACKAGING	PART NO. FOR TUBE WITHOUT CAP PACKAGING	PART NO. FOR TUBE WITH CAP PACKAGING	PART NO. FOR TAPE & REEL WITHOUT CAP PACKAGING	PART NO. FOR TAPE & REEL WITH CAP PACKAGING	CKT SIZE	VOID POSITION	PLATING TYPE	DIMENSION					
								A	B	F	M	P	G
87914-1811	-----	-----	-----	-----	18	-----	1	22.86	20.32	10.92	5.84	2.79	----
87914-1821	-----	-----	-----	-----	18	-----	1	22.86	20.32	12.25	7.00	2.96	----
87914-1831	-----	-----	-----	-----	18	-----	1	22.86	20.32	13.38	6.09	5.00	----
87914-1812	-----	-----	-----	-----	18	-----	2	22.86	20.32	10.92	5.84	2.79	----
87914-1822	-----	-----	-----	-----	18	-----	2	22.86	20.32	12.25	7.00	2.96	----
87914-1832	-----	-----	-----	-----	18	-----	2	22.86	20.32	13.38	6.09	5.00	----
87914-1813	-----	-----	-----	-----	18	-----	3	22.86	20.32	10.92	5.84	2.79	----
87914-1823	-----	-----	-----	-----	18	-----	3	22.86	20.32	12.25	7.00	2.96	----
87914-1833	-----	-----	-----	-----	18	-----	3	22.86	20.32	13.38	6.09	5.00	----
87914-1814	-----	-----	-----	-----	18	-----	4	22.86	20.32	10.92	5.84	2.79	----
87914-1824	-----	-----	-----	-----	18	-----	4	22.86	20.32	12.25	7.00	2.96	----
87914-1834	-----	-----	-----	-----	18	-----	4	22.86	20.32	13.38	6.09	5.00	----
87914-1815	-----	-----	-----	-----	18	-----	5	22.86	20.32	10.92	5.84	2.79	----
87914-1825	-----	-----	-----	-----	18	-----	5	22.86	20.32	12.25	7.00	2.96	----
87914-1835	-----	-----	-----	-----	18	-----	5	22.86	20.32	13.38	6.09	5.00	----
87914-1816	-----	-----	-----	-----	18	-----	6	22.86	20.32	10.92	5.84	2.79	----
87914-1826	-----	-----	-----	-----	18	-----	6	22.86	20.32	12.25	7.00	2.96	----
87914-1836	-----	-----	-----	-----	18	-----	6	22.86	20.32	13.38	6.09	5.00	----
-----	-----	87914-1807	-----	-----	18	-----	6	22.86	20.32	17.02	11.05	3.68	18.02

THIS DRAWING CONTAINS INFORMATION THAT IS PROPRIETARY TO MOLEX ELECTRONIC TECHNOLOGIES, LLC AND SHOULD NOT BE USED WITHOUT WRITTEN PERMISSION

MIGRATED TO NX EC NO: 114466 DRWN: PKH CHK'D: ISHWARG REV APPR: ISHWARG	GENERAL TOLERANCES (UNLESS SPECIFIED)		DIMENSION UNITS		SCALE					
			MM	INCH	MM	NTS				
	4 PLACES ±		MM	INCH	DRWN BY	DATE	2.54MM PITCH DUAL ROW HEADER SINGLE WAFER, T/H			
	3 PLACES ±				KCHO	2004/11/05				
	2 PLACES ± 0.2				CHK'D BY	DATE				
	1 PLACES ±				PTLIM	2004/12/08				
	0 PLACES ±				APPR BY	DATE				
	ANGULAR TOL = 3.0		DRAWING SIZE		THIRD ANGLE PROJECTION		PRODUCT CUSTOMER DRAWING			
	DRAFT WHERE APPLICABLE MUST REMAIN WITHIN DIMENSIONS		A3				SERIES	MATERIAL NUMBER	CUSTOMER	
							87914	SEE TABLE	GENERAL MARKET	
						DOCUMENT NUMBER		DOC TYPE	DOC PART	SHEET NUMBER
						SD-87914-013		PSD	000	14 OF 45

RELEASE STATUS	RELEASE DATE
----------------	--------------

PART NO FOR TRAY PACKAGING	PART NO. FOR TUBE WITHOUT CAP PACKAGING	PART NO. FOR TUBE WITH CAP PACKAGING	PART NO. FOR TAPE & REEL WITHOUT CAP PACKAGING	PART NO. FOR TAPE & REEL WITH CAP PACKAGING	CKT SIZE	VOID POSITION	PLATING TYPE	DIMENSION				
								A	B	F	M	P
87914-2011	-----	-----	-----	-----	20	-----	1	25.40	22.86	10.92	5.84	2.79
87914-2021	-----	-----	-----	-----	20	-----	1	25.40	22.86	12.25	7.00	2.96
87914-2031	-----	-----	-----	-----	20	-----	1	25.40	22.86	13.38	6.09	5.00
87914-2012	-----	-----	-----	-----	20	-----	2	25.40	22.86	10.92	5.84	2.79
87914-2022	-----	-----	-----	-----	20	-----	2	25.40	22.86	12.25	7.00	2.96
87914-2032	-----	-----	-----	-----	20	-----	2	25.40	22.86	13.38	6.09	5.00
87914-2013	-----	-----	-----	-----	20	-----	3	25.40	22.86	10.92	5.84	2.79
87914-2023	-----	-----	-----	-----	20	-----	3	25.40	22.86	12.25	7.00	2.96
87914-2033	-----	-----	-----	-----	20	-----	3	25.40	22.86	13.38	6.09	5.00
87914-2014	-----	-----	-----	-----	20	-----	4	25.40	22.86	10.92	5.84	2.79
87914-2024	-----	-----	-----	-----	20	-----	4	25.40	22.86	12.25	7.00	2.96
87914-2034	-----	-----	-----	-----	20	-----	4	25.40	22.86	13.38	6.09	5.00
87914-2015	-----	-----	-----	-----	20	-----	5	25.40	22.86	10.92	5.84	2.79
87914-2025	-----	-----	-----	-----	20	-----	5	25.40	22.86	12.25	7.00	2.96
87914-2035	-----	-----	-----	-----	20	-----	5	25.40	22.86	13.38	6.09	5.00
87914-2016	-----	-----	-----	-----	20	-----	6	25.40	22.86	10.92	5.84	2.79
87914-2026	-----	-----	-----	-----	20	-----	6	25.40	22.86	12.25	7.00	2.96
87914-2036	-----	-----	-----	-----	20	-----	6	25.40	22.86	13.38	6.09	5.00

THIS DRAWING CONTAINS INFORMATION THAT IS PROPRIETARY TO MOLEX ELECTRONIC TECHNOLOGIES, LLC AND SHOULD NOT BE USED WITHOUT WRITTEN PERMISSION

MIGRATED TO NX EC NO: 114466 DRWN: PKH CHKD: REV: APPR: ISHWARG	2017/01/18		2017/03/15		GENERAL TOLERANCES (UNLESS SPECIFIED)		DIMENSION UNITS		SCALE								
							MM INCH		MM NTS								
	4 PLACES ±		±		DRWN BY		KCHO		DATE		2.54MM PITCH DUAL ROW HEADER SINGLE WAFER, T/H						
	3 PLACES ±		±		CHK'D BY		PTLIM		DATE								
	2 PLACES ± 0.2		±		APPR BY		MLONG		DATE		PRODUCT CUSTOMER DRAWING						
	1 PLACES ±		±		DRAWING SIZE		A3		THIRD ANGLE PROJECTION								
0 PLACES ±		±		ANGULAR TOL = 3.0		DRAFT WHERE APPLICABLE MUST REMAIN WITHIN DIMENSIONS				SERIES		MATERIAL NUMBER		CUSTOMER			
D17										87914		SEE TABLE		GENERAL MARKET			
										DOCUMENT NUMBER		DOC TYPE		DOC PART		SHEET NUMBER	
										SD-87914-013		PSD		000		15 OF 45	

PART NO FOR TRAY PACKAGING	PART NO. FOR TUBE WITHOUT CAP PACKAGING	PART NO. FOR TUBE WITH CAP PACKAGING	PART NO. FOR TAPE & REEL WITHOUT CAP PACKAGING	PART NO. FOR TAPE & REEL WITH CAP PACKAGING	CKT SIZE	VOID POSITION	PLATING TYPE	DIMENSION				
								A	B	F	M	P
87914-2211	-----	-----	-----	-----	22	-----	1	27.94	25.40	10.92	5.84	2.79
87914-2221	-----	-----	-----	-----	22	-----	1	27.94	25.40	12.25	7.00	2.96
87914-2231	-----	-----	-----	-----	22	-----	1	27.94	25.40	13.38	6.09	5.00
87914-2212	-----	-----	-----	-----	22	-----	2	27.94	25.40	10.92	5.84	2.79
87914-2222	-----	-----	-----	-----	22	-----	2	27.94	25.40	12.25	7.00	2.96
87914-2232	-----	-----	-----	-----	22	-----	2	27.94	25.40	13.38	6.09	5.00
87914-2213	-----	-----	-----	-----	22	-----	3	27.94	25.40	10.92	5.84	2.79
87914-2223	-----	-----	-----	-----	22	-----	3	27.94	25.40	12.25	7.00	2.96
87914-2233	-----	-----	-----	-----	22	-----	3	27.94	25.40	13.38	6.09	5.00
87914-2214	-----	-----	-----	-----	22	-----	4	27.94	25.40	10.92	5.84	2.79
87914-2224	-----	-----	-----	-----	22	-----	4	27.94	25.40	12.25	7.00	2.96
87914-2234	-----	-----	-----	-----	22	-----	4	27.94	25.40	13.38	6.09	5.00
87914-2215	-----	-----	-----	-----	22	-----	5	27.94	25.40	10.92	5.84	2.79
87914-2225	-----	-----	-----	-----	22	-----	5	27.94	25.40	12.25	7.00	2.96
87914-2235	-----	-----	-----	-----	22	-----	5	27.94	25.40	13.38	6.09	5.00
87914-2216	-----	-----	-----	-----	22	-----	6	27.94	25.40	10.92	5.84	2.79
87914-2226	-----	-----	-----	-----	22	-----	6	27.94	25.40	12.25	7.00	2.96
87914-2236	-----	-----	-----	-----	22	-----	6	27.94	25.40	13.38	6.09	5.00

THIS DRAWING CONTAINS INFORMATION THAT IS PROPRIETARY TO MOLEX ELECTRONIC TECHNOLOGIES, LLC AND SHOULD NOT BE USED WITHOUT WRITTEN PERMISSION

MIGRATED TO NX EC NO: 114466 DRWN: PKH CHK'D: ISHWARG REV APPR: ISHWARG	GENERAL TOLERANCES (UNLESS SPECIFIED)		DIMENSION UNITS		SCALE					
		MM	INCH	MM	NTS					
	4 PLACES ±			DRWN BY	DATE			2.54MM PITCH DUAL ROW HEADER SINGLE WAFER, T/H		
	3 PLACES ±			KCHO	2004/11/05					
	2 PLACES ± 0.2			CHK'D BY	DATE					
	1 PLACES ±			PTLIM	2004/12/08					
0 PLACES ±			APPR BY	DATE						
			MLONG	2010/09/06		PRODUCT CUSTOMER DRAWING				
ANGULAR TOL = 3.0			DRAWING SIZE	THIRD ANGLE PROJECTION		SERIES	MATERIAL NUMBER	CUSTOMER		
DRAFT WHERE APPLICABLE MUST REMAIN WITHIN DIMENSIONS			A3			87914	SEE TABLE	GENERAL MARKET		
						DOCUMENT NUMBER		DOC TYPE	DOC PART	SHEET NUMBER
						SD-87914-013		PSD	000	16 OF 45

PART NO FOR TRAY PACKAGING	PART NO. FOR TUBE WITHOUT CAP PACKAGING	PART NO. FOR TUBE WITH CAP PACKAGING	PART NO. FOR TAPE & REEL WITHOUT CAP PACKAGING	PART NO. FOR TAPE & REEL WITH CAP PACKAGING	CKT SIZE	VOID POSITION	PLATING TYPE	DIMENSION				
								A	B	F	M	P
87914-2411	-----	-----	-----	-----	24	-----	1	30.48	27.94	10.92	5.84	2.79
87914-2421	-----	-----	-----	-----	24	-----	1	30.48	27.94	12.25	7.00	2.96
87914-2431	-----	-----	-----	-----	24	-----	1	30.48	27.94	13.38	6.09	5.00
87914-2412	-----	-----	-----	-----	24	-----	2	30.48	27.94	10.92	5.84	2.79
87914-2422	-----	-----	-----	-----	24	-----	2	30.48	27.94	12.25	7.00	2.96
87914-2432	-----	-----	-----	-----	24	-----	2	30.48	27.94	13.38	6.09	5.00
87914-2413	-----	-----	-----	-----	24	-----	3	30.48	27.94	10.92	5.84	2.79
87914-2423	-----	-----	-----	-----	24	-----	3	30.48	27.94	12.25	7.00	2.96
87914-2433	-----	-----	-----	-----	24	-----	3	30.48	27.94	13.38	6.09	5.00
87914-2414	-----	-----	-----	-----	24	-----	4	30.48	27.94	10.92	5.84	2.79
87914-2424	-----	-----	-----	-----	24	-----	4	30.48	27.94	12.25	7.00	2.96
87914-2434	-----	-----	-----	-----	24	-----	4	30.48	27.94	13.38	6.09	5.00
87914-2415	-----	-----	-----	-----	24	-----	5	30.48	27.94	10.92	5.84	2.79
87914-2425	-----	-----	-----	-----	24	-----	5	30.48	27.94	12.25	7.00	2.96
87914-2435	-----	-----	-----	-----	24	-----	5	30.48	27.94	13.38	6.09	5.00
87914-2416	-----	-----	-----	-----	24	-----	6	30.48	27.94	10.92	5.84	2.79
87914-2426	-----	-----	-----	-----	24	-----	6	30.48	27.94	12.25	7.00	2.96
87914-2436	-----	-----	-----	-----	24	-----	6	30.48	27.94	13.38	6.09	5.00

THIS DRAWING CONTAINS INFORMATION THAT IS PROPRIETARY TO MOLEX ELECTRONIC TECHNOLOGIES, LLC AND SHOULD NOT BE USED WITHOUT WRITTEN PERMISSION

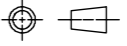
MIGRATED TO NX EC NO: 114466 DRWN: PKH CHK'D: REV APPR: ISHWARG	2017/01/18		2017/03/15		GENERAL TOLERANCES (UNLESS SPECIFIED)		DIMENSION UNITS		SCALE				
							MM INCH		MM NTS				
	4 PLACES ±		±		DRWN BY		KCHO		DATE		2.54MM PITCH DUAL ROW HEADER SINGLE WAFER, T/H		
	3 PLACES ±		±		CHK'D BY		PTLIM		DATE				
	2 PLACES ± 0.2		±		APPR BY		MLONG		DATE				
1 PLACES ±		±								PRODUCT CUSTOMER DRAWING			
0 PLACES ±		±								SERIES MATERIAL NUMBER CUSTOMER 87914 SEE TABLE GENERAL MARKET			
				ANGULAR TOL = 3.0		DRAWING SIZE		THIRD ANGLE PROJECTION		DOCUMENT NUMBER DOC TYPE DOC PART SHEET NUMBER SD-87914-013 PSD 000 17 OF 45			
				DRAFT WHERE APPLICABLE MUST REMAIN WITHIN DIMENSIONS		A3							

RELEASE STATUS	RELEASE DATE
----------------	--------------

PART NO FOR TRAY PACKAGING	PART NO. FOR TUBE WITHOUT CAP PACKAGING	PART NO. FOR TUBE WITH CAP PACKAGING	PART NO. FOR TAPE & REEL WITHOUT CAP PACKAGING	PART NO. FOR TAPE & REEL WITH CAP PACKAGING	CKT SIZE	VOID POSITION	PLATING TYPE	DIMENSION				
								A	B	F	M	P
87914-2611	-----	-----	-----	-----	26	-----	1	33.02	30.48	10.92	5.84	2.79
87914-2621	-----	-----	-----	-----	26	-----	1	33.02	30.48	12.25	7.00	2.96
87914-2631	-----	-----	-----	-----	26	-----	1	33.02	30.48	13.38	6.09	5.00
87914-2612	-----	-----	-----	-----	26	-----	2	33.02	30.48	10.92	5.84	2.79
87914-2622	-----	-----	-----	-----	26	-----	2	33.02	30.48	12.25	7.00	2.96
87914-2632	-----	-----	-----	-----	26	-----	2	33.02	30.48	13.38	6.09	5.00
87914-2613	-----	-----	-----	-----	26	-----	3	33.02	30.48	10.92	5.84	2.79
87914-2623	-----	-----	-----	-----	26	-----	3	33.02	30.48	12.25	7.00	2.96
87914-2633	-----	-----	-----	-----	26	-----	3	33.02	30.48	13.38	6.09	5.00
87914-2614	-----	-----	-----	-----	26	-----	4	33.02	30.48	10.92	5.84	2.79
87914-2624	-----	-----	-----	-----	26	-----	4	33.02	30.48	12.25	7.00	2.96
87914-2634	-----	-----	-----	-----	26	-----	4	33.02	30.48	13.38	6.09	5.00
87914-2615	-----	-----	-----	-----	26	-----	5	33.02	30.48	10.92	5.84	2.79
87914-2625	-----	-----	-----	-----	26	-----	5	33.02	30.48	12.25	7.00	2.96
87914-2635	-----	-----	-----	-----	26	-----	5	33.02	30.48	13.38	6.09	5.00
87914-2616	-----	-----	-----	-----	26	-----	6	33.02	30.48	10.92	5.84	2.79
87914-2626	-----	-----	-----	-----	26	-----	6	33.02	30.48	12.25	7.00	2.96
87914-2636	-----	-----	-----	-----	26	-----	6	33.02	30.48	13.38	6.09	5.00

THIS DRAWING CONTAINS INFORMATION THAT IS PROPRIETARY TO MOLEX ELECTRONIC TECHNOLOGIES, LLC AND SHOULD NOT BE USED WITHOUT WRITTEN PERMISSION

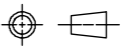
MIGRATED TO NX EC NO: 114466 DRWN: PKH CHK'D: ISHWARG APPR: ISHWARG REV:	2017/01/18		2017/03/15		GENERAL TOLERANCES (UNLESS SPECIFIED)		DIMENSION UNITS		SCALE					
							MM		NTS					
					4 PLACES ±		MM		INCH		DRWN BY		DATE	
					3 PLACES ±						KCHO		2004/11/05	
					2 PLACES ± 0.2						CHK'D BY		DATE	
					1 PLACES ±						PTLIM		2004/12/08	
					0 PLACES ±						APPR BY		DATE	
					ANGULAR TOL = 3.0						MLONG		2010/09/06	
					DRAFT WHERE APPLICABLE MUST REMAIN WITHIN DIMENSIONS						DRAWING SIZE		THIRD ANGLE PROJECTION	
											A3			
SERIES			MATERIAL NUMBER			CUSTOMER			DOCUMENT NUMBER			DOC TYPE	DOC PART	SHEET NUMBER
87914			SEE TABLE			GENERAL MARKET			SD-87914-013			PSD	000	18 OF 45

RELEASE STATUS	RELEASE DATE
----------------	--------------

PART NO FOR TRAY PACKAGING	PART NO. FOR TUBE WITHOUT CAP PACKAGING	PART NO. FOR TUBE WITH CAP PACKAGING	PART NO. FOR TAPE & REEL WITHOUT CAP PACKAGING	PART NO. FOR TAPE & REEL WITH CAP PACKAGING	CKT SIZE	VOID POSITION	PLATING TYPE	DIMENSION				
								A	B	F	M	P
87914-2811	-----	-----	-----	-----	28	-----	1	35.56	33.02	10.92	5.84	2.79
87914-2821	-----	-----	-----	-----	28	-----	1	35.56	33.02	12.25	7.00	2.96
87914-2831	-----	-----	-----	-----	28	-----	1	35.56	33.02	13.38	6.09	5.00
87914-2812	-----	-----	-----	-----	28	-----	2	35.56	33.02	10.92	5.84	2.79
87914-2822	-----	-----	-----	-----	28	-----	2	35.56	33.02	12.25	7.00	2.96
87914-2832	-----	-----	-----	-----	28	-----	2	35.56	33.02	13.38	6.09	5.00
87914-2813	-----	-----	-----	-----	28	-----	3	35.56	33.02	10.92	5.84	2.79
87914-2823	-----	-----	-----	-----	28	-----	3	35.56	33.02	12.25	7.00	2.96
87914-2833	-----	-----	-----	-----	28	-----	3	35.56	33.02	13.38	6.09	5.00
87914-2814	-----	-----	-----	-----	28	-----	4	35.56	33.02	10.92	5.84	2.79
87914-2824	-----	-----	-----	-----	28	-----	4	35.56	33.02	12.25	7.00	2.96
87914-2834	-----	-----	-----	-----	28	-----	4	35.56	33.02	13.38	6.09	5.00
87914-2815	-----	-----	-----	-----	28	-----	5	35.56	33.02	10.92	5.84	2.79
87914-2825	-----	-----	-----	-----	28	-----	5	35.56	33.02	12.25	7.00	2.96
87914-2835	-----	-----	-----	-----	28	-----	5	35.56	33.02	13.38	6.09	5.00
87914-2816	-----	-----	-----	-----	28	-----	6	35.56	33.02	10.92	5.84	2.79
87914-2826	-----	-----	-----	-----	28	-----	6	35.56	33.02	12.25	7.00	2.96
87914-2836	-----	-----	-----	-----	28	-----	6	35.56	33.02	13.38	6.09	5.00

THIS DRAWING CONTAINS INFORMATION THAT IS PROPRIETARY TO MOLEX ELECTRONIC TECHNOLOGIES, LLC AND SHOULD NOT BE USED WITHOUT WRITTEN PERMISSION

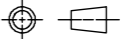
MIGRATED TO NX 2017/01/18 EC NO: 114466 DRWN: PKH CHK'D: ISHWARG APP'R: ISHWARG	GENERAL TOLERANCES (UNLESS SPECIFIED)		DIMENSION UNITS		SCALE							
			MM	INCH	MM	NTS						
	4 PLACES	±		±	DRWN BY	DATE			2.54MM PITCH DUAL ROW HEADER SINGLE WAFER, T/H			
	3 PLACES	±		±	KCHO	2004/11/05						
	2 PLACES	± 0.2		±	CHK'D BY	DATE						
	1 PLACES	±		±	PTLIM	2004/12/08						
	0 PLACES	±		±	APPR BY	DATE						
	ANGULAR TOL = 3.0		DRAWING SIZE		THIRD ANGLE PROJECTION		PRODUCT CUSTOMER DRAWING					
	DRAFT WHERE APPLICABLE MUST REMAIN WITHIN DIMENSIONS		A3				SERIES	MATERIAL NUMBER			CUSTOMER	
							87914	SEE TABLE			GENERAL MARKET	
						DOCUMENT NUMBER		DOC TYPE			DOC PART	SHEET NUMBER
						SD-87914-013		PSD			000	19 OF 45

RELEASE STATUS	RELEASE DATE
----------------	--------------

PART NO FOR TRAY PACKAGING	PART NO. FOR TUBE WITHOUT CAP PACKAGING	PART NO. FOR TUBE WITH CAP PACKAGING	PART NO. FOR TAPE & REEL WITHOUT CAP PACKAGING	PART NO. FOR TAPE & REEL WITH CAP PACKAGING	CKT SIZE	VOID POSITION	PLATING TYPE	DIMENSION				
								A	B	F	M	P
87914-3011	-----	-----	-----	-----	30	-----	1	38.10	35.56	10.92	5.84	2.79
87914-3021	-----	-----	-----	-----	30	-----	1	38.10	35.56	12.25	7.00	2.96
87914-3031	-----	-----	-----	-----	30	-----	1	38.10	35.56	13.38	6.09	5.00
87914-3012	-----	-----	-----	-----	30	-----	2	38.10	35.56	10.92	5.84	2.79
87914-3022	-----	-----	-----	-----	30	-----	2	38.10	35.56	12.25	7.00	2.96
87914-3032	-----	-----	-----	-----	30	-----	2	38.10	35.56	13.38	6.09	5.00
87914-3013	-----	-----	-----	-----	30	-----	3	38.10	35.56	10.92	5.84	2.79
87914-3023	-----	-----	-----	-----	30	-----	3	38.10	35.56	12.25	7.00	2.96
87914-3033	-----	-----	-----	-----	30	-----	3	38.10	35.56	13.38	6.09	5.00
87914-3014	-----	-----	-----	-----	30	-----	4	38.10	35.56	10.92	5.84	2.79
87914-3024	-----	-----	-----	-----	30	-----	4	38.10	35.56	12.25	7.00	2.96
87914-3034	-----	-----	-----	-----	30	-----	4	38.10	35.56	13.38	6.09	5.00
87914-3015	-----	-----	-----	-----	30	-----	5	38.10	35.56	10.92	5.84	2.79
87914-3025	-----	-----	-----	-----	30	-----	5	38.10	35.56	12.25	7.00	2.96
87914-3035	-----	-----	-----	-----	30	-----	5	38.10	35.56	13.38	6.09	5.00
87914-3016	-----	-----	-----	-----	30	-----	6	38.10	35.56	10.92	5.84	2.79
87914-3026	-----	-----	-----	-----	30	-----	6	38.10	35.56	12.25	7.00	2.96
87914-3036	-----	-----	-----	-----	30	-----	6	38.10	35.56	13.38	6.09	5.00

THIS DRAWING CONTAINS INFORMATION THAT IS PROPRIETARY TO MOLEX ELECTRONIC TECHNOLOGIES, LLC AND SHOULD NOT BE USED WITHOUT WRITTEN PERMISSION												
MIGRATED TO NX 2017/01/18 EC NO: 114466 DRWN: PKH CHK'D: REV APPR: ISHWARG 2017/03/15	GENERAL TOLERANCES (UNLESS SPECIFIED)				DIMENSION UNITS		SCALE		<h1>molex®</h1>			
		MM	INCH	DRWN BY	DATE	MM	NTS	2.54MM PITCH DUAL ROW HEADER SINGLE WAFER, T/H				
	4 PLACES	±	±	KCHO	2004/11/05	PRODUCT CUSTOMER DRAWING						
	3 PLACES	±	±	CHK'D BY	DATE					SERIES MATERIAL NUMBER CUSTOMER 87914 SEE TABLE GENERAL MARKET		
	2 PLACES	± 0.2	±	PTLIM	2004/12/08	DOCUMENT NUMBER DOC TYPE DOC PART SHEET NUMBER SD-87914-013 PSD 000 20 OF 45						
	1 PLACES	±	±	APPR BY	DATE					A3		
	0 PLACES	±	±	MLONG	2010/09/06	DRAFT WHERE APPLICABLE MUST REMAIN WITHIN DIMENSIONS						
		ANGULAR TOL = 3.0			DRAWING SIZE					THIRD ANGLE PROJECTION		

RELEASE STATUS	RELEASE DATE
----------------	--------------

PART NO FOR TRAY PACKAGING	PART NO. FOR TUBE WITHOUT CAP PACKAGING	PART NO. FOR TUBE WITH CAP PACKAGING	PART NO. FOR TAPE & REEL WITHOUT CAP PACKAGING	PART NO. FOR TAPE & REEL WITH CAP PACKAGING	CKT SIZE	VOID POSITION	PLATING TYPE	DIMENSION				
								A	B	F	M	P
87914-3211	-----	-----	-----	-----	32	-----	1	40.64	38.10	10.92	5.84	2.79
87914-3221	-----	-----	-----	-----	32	-----	1	40.64	38.10	12.25	7.00	2.96
87914-3231	-----	-----	-----	-----	32	-----	1	40.64	38.10	13.38	6.09	5.00
87914-3212	-----	-----	-----	-----	32	-----	2	40.64	38.10	10.92	5.84	2.79
87914-3222	-----	-----	-----	-----	32	-----	2	40.64	38.10	12.25	7.00	2.96
87914-3232	-----	-----	-----	-----	32	-----	2	40.64	38.10	13.38	6.09	5.00
87914-3213	-----	-----	-----	-----	32	-----	3	40.64	38.10	10.92	5.84	2.79
87914-3223	-----	-----	-----	-----	32	-----	3	40.64	38.10	12.25	7.00	2.96
87914-3233	-----	-----	-----	-----	32	-----	3	40.64	38.10	13.38	6.09	5.00
87914-3214	-----	-----	-----	-----	32	-----	4	40.64	38.10	10.92	5.84	2.79
87914-3224	-----	-----	-----	-----	32	-----	4	40.64	38.10	12.25	7.00	2.96
87914-3234	-----	-----	-----	-----	32	-----	4	40.64	38.10	13.38	6.09	5.00
87914-3215	-----	-----	-----	-----	32	-----	5	40.64	38.10	10.92	5.84	2.79
87914-3225	-----	-----	-----	-----	32	-----	5	40.64	38.10	12.25	7.00	2.96
87914-3235	-----	-----	-----	-----	32	-----	5	40.64	38.10	13.38	6.09	5.00
87914-3216	-----	-----	-----	-----	32	-----	6	40.64	38.10	10.92	5.84	2.79
87914-3226	-----	-----	-----	-----	32	-----	6	40.64	38.10	12.25	7.00	2.96
87914-3236	-----	-----	-----	-----	32	-----	6	40.64	38.10	13.38	6.09	5.00

THIS DRAWING CONTAINS INFORMATION THAT IS PROPRIETARY TO MOLEX ELECTRONIC TECHNOLOGIES, LLC AND SHOULD NOT BE USED WITHOUT WRITTEN PERMISSION

MIGRATED TO NX 2017/01/18	EC NO: 114466 DRWN: PKH	CHKD: ISHWARG	APPR: ISHWARG	GENERAL TOLERANCES (UNLESS SPECIFIED)		DIMENSION UNITS		SCALE		molex®					
				MM	INCH	MM	INCH	MM	NTS						
REV	D17	REV	D17	4 PLACES	±	±	DRWN BY	DATE	2.54MM PITCH DUAL ROW HEADER SINGLE WAFER, T/H						
				3 PLACES	±	±	KCHO	2004/11/05							
				2 PLACES	± 0.2	±	CHK'D BY	DATE							
				1 PLACES	±	±	PTLIM	2004/12/08	PRODUCT CUSTOMER DRAWING						
				0 PLACES	±	±	APPR BY	DATE	MLONG		2010/09/06	SERIES	MATERIAL NUMBER	CUSTOMER	
				ANGULAR TOL = 3.0				DRAWING SIZE		THIRD ANGLE PROJECTION		87914	SEE TABLE	GENERAL MARKET	
DRAFT WHERE APPLICABLE MUST REMAIN WITHIN DIMENSIONS				A3				DOCUMENT NUMBER	DOC TYPE	DOC PART	SHEET NUMBER				
								SD-87914-013	PSD	000	21 OF 45				

RELEASE STATUS	RELEASE DATE
----------------	--------------

PART NO FOR TRAY PACKAGING	PART NO. FOR TUBE WITHOUT CAP PACKAGING	PART NO. FOR TUBE WITH CAP PACKAGING	PART NO. FOR TAPE & REEL WITHOUT CAP PACKAGING	PART NO. FOR TAPE & REEL WITH CAP PACKAGING	CKT SIZE	VOID POSITION	PLATING TYPE	DIMENSION				
								A	B	F	M	P
87914-3411	-----	-----	-----	-----	34	-----	1	43.18	40.64	10.92	5.84	2.79
87914-3421	-----	-----	-----	-----	34	-----	1	43.18	40.64	12.25	7.00	2.96
87914-3431	-----	-----	-----	-----	34	-----	1	43.18	40.64	13.38	6.09	5.00
87914-3412	-----	-----	-----	-----	34	-----	2	43.18	40.64	10.92	5.84	2.79
87914-3422	-----	-----	-----	-----	34	-----	2	43.18	40.64	12.25	7.00	2.96
87914-3432	-----	-----	-----	-----	34	-----	2	43.18	40.64	13.38	6.09	5.00
87914-3413	-----	-----	-----	-----	34	-----	3	43.18	40.64	10.92	5.84	2.79
87914-3423	-----	-----	-----	-----	34	-----	3	43.18	40.64	12.25	7.00	2.96
87914-3433	-----	-----	-----	-----	34	-----	3	43.18	40.64	13.38	6.09	5.00
87914-3414	-----	-----	-----	-----	34	-----	4	43.18	40.64	10.92	5.84	2.79
87914-3424	-----	-----	-----	-----	34	-----	4	43.18	40.64	12.25	7.00	2.96
87914-3434	-----	-----	-----	-----	34	-----	4	43.18	40.64	13.38	6.09	5.00
87914-3415	-----	-----	-----	-----	34	-----	5	43.18	40.64	10.92	5.84	2.79
87914-3425	-----	-----	-----	-----	34	-----	5	43.18	40.64	12.25	7.00	2.96
87914-3435	-----	-----	-----	-----	34	-----	5	43.18	40.64	13.38	6.09	5.00
87914-3416	-----	-----	-----	-----	34	-----	6	43.18	40.64	10.92	5.84	2.79
87914-3426	-----	-----	-----	-----	34	-----	6	43.18	40.64	12.25	7.00	2.96
87914-3436	-----	-----	-----	-----	34	-----	6	43.18	40.64	13.38	6.09	5.00

THIS DRAWING CONTAINS INFORMATION THAT IS PROPRIETARY TO MOLEX ELECTRONIC TECHNOLOGIES, LLC AND SHOULD NOT BE USED WITHOUT WRITTEN PERMISSION

MIGRATED TO NX 2017/01/18 EC NO: 114466 DRWN: PKH CHK'D: REV APPR: ISHWARG 2017/03/15	GENERAL TOLERANCES (UNLESS SPECIFIED)		DIMENSION UNITS		SCALE					
			MM	INCH	MM	NTS				
	4 PLACES	±		±	DRWN BY	DATE		2.54MM PITCH DUAL ROW HEADER SINGLE WAFER, T/H PRODUCT CUSTOMER DRAWING		
	3 PLACES	±		±	KCHO	2004/11/05				
	2 PLACES	± 0.2		±	CHK'D BY	DATE				
	1 PLACES	±		±	PTLIM	2004/12/08				
	0 PLACES	±		±	APPR BY	DATE				
	ANGULAR TOL = 3.0				MLONG	2010/09/06		SERIES		
	DRAFT WHERE APPLICABLE MUST REMAIN WITHIN DIMENSIONS				DRAWING SIZE	THIRD ANGLE PROJECTION		87914	MATERIAL NUMBER	CUSTOMER
					A3			SEE TABLE		GENERAL MARKET
						DOCUMENT NUMBER		DOC TYPE	DOC PART	SHEET NUMBER
						SD-87914-013		PSD	000	22 OF 45

RELEASE STATUS	RELEASE DATE
----------------	--------------

PART NO FOR TRAY PACKAGING	PART NO. FOR TUBE WITHOUT CAP PACKAGING	PART NO. FOR TUBE WITH CAP PACKAGING	PART NO. FOR TAPE & REEL WITHOUT CAP PACKAGING	PART NO. FOR TAPE & REEL WITH CAP PACKAGING	CKT SIZE	VOID POSITION	PLATING TYPE	DIMENSION				
								A	B	F	M	P
87914-3611	-----	-----	-----	-----	36	-----	1	45.72	43.18	10.92	5.84	2.79
87914-3621	-----	-----	-----	-----	36	-----	1	45.72	43.18	12.25	7.00	2.96
87914-3631	-----	-----	-----	-----	36	-----	1	45.72	43.18	13.38	6.09	5.00
87914-3612	-----	-----	-----	-----	36	-----	2	45.72	43.18	10.92	5.84	2.79
87914-3622	-----	-----	-----	-----	36	-----	2	45.72	43.18	12.25	7.00	2.96
87914-3632	-----	-----	-----	-----	36	-----	2	45.72	43.18	13.38	6.09	5.00
87914-3613	-----	-----	-----	-----	36	-----	3	45.72	43.18	10.92	5.84	2.79
87914-3623	-----	-----	-----	-----	36	-----	3	45.72	43.18	12.25	7.00	2.96
87914-3633	-----	-----	-----	-----	36	-----	3	45.72	43.18	13.38	6.09	5.00
87914-3614	-----	-----	-----	-----	36	-----	4	45.72	43.18	10.92	5.84	2.79
87914-3624	-----	-----	-----	-----	36	-----	4	45.72	43.18	12.25	7.00	2.96
87914-3634	-----	-----	-----	-----	36	-----	4	45.72	43.18	13.38	6.09	5.00
87914-3615	-----	-----	-----	-----	36	-----	5	45.72	43.18	10.92	5.84	2.79
87914-3625	-----	-----	-----	-----	36	-----	5	45.72	43.18	12.25	7.00	2.96
87914-3635	-----	-----	-----	-----	36	-----	5	45.72	43.18	13.38	6.09	5.00
87914-3616	-----	-----	-----	-----	36	-----	6	45.72	43.18	10.92	5.84	2.79
87914-3626	-----	-----	-----	-----	36	-----	6	45.72	43.18	12.25	7.00	2.96
87914-3636	-----	-----	-----	-----	36	-----	6	45.72	43.18	13.38	6.09	5.00
87914-3637	-----	-----	-----	-----	36	-----	6	45.72	43.18	12.10	7.01	2.60

THIS DRAWING CONTAINS INFORMATION THAT IS PROPRIETARY TO MOLEX ELECTRONIC TECHNOLOGIES, LLC AND SHOULD NOT BE USED WITHOUT WRITTEN PERMISSION

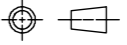
MIGRATED TO NX EC NO: 114466 DRWN: PKH CHK'D: ISHWARG APPR: ISHWARG REV:	GENERAL TOLERANCES (UNLESS SPECIFIED)		DIMENSION UNITS		SCALE												
			MM	INCH	MM	NTS											
	4 PLACES	±	±	DRWN BY		DATE		2.54MM PITCH DUAL ROW HEADER SINGLE WAFER, T/H									
	3 PLACES	±	±	KCHO		2004/11/05											
	2 PLACES	± 0.2	±	CHK'D BY		DATE											
	1 PLACES	±	±	PTLIM		2004/12/08											
	0 PLACES	±	±	APPR BY		DATE											
	ANGULAR TOL = 3.0			MLONG		2010/09/06		PRODUCT CUSTOMER DRAWING									
	DRAFT WHERE APPLICABLE MUST REMAIN WITHIN DIMENSIONS			DRAWING SIZE		THIRD ANGLE PROJECTION		<table border="1" style="width: 100%;"> <tr> <td>SERIES</td> <td>MATERIAL NUMBER</td> <td>CUSTOMER</td> </tr> <tr> <td>87914</td> <td>SEE TABLE</td> <td>GENERAL MARKET</td> </tr> </table>			SERIES	MATERIAL NUMBER	CUSTOMER	87914	SEE TABLE	GENERAL MARKET	
	SERIES	MATERIAL NUMBER	CUSTOMER														
87914	SEE TABLE	GENERAL MARKET															
			A3				<table border="1" style="width: 100%;"> <tr> <td>DOCUMENT NUMBER</td> <td>DOC TYPE</td> <td>DOC PART</td> <td>SHEET NUMBER</td> </tr> <tr> <td>SD-87914-013</td> <td>PSD</td> <td>000</td> <td>23 OF 45</td> </tr> </table>			DOCUMENT NUMBER	DOC TYPE	DOC PART	SHEET NUMBER	SD-87914-013	PSD	000	23 OF 45
DOCUMENT NUMBER	DOC TYPE	DOC PART	SHEET NUMBER														
SD-87914-013	PSD	000	23 OF 45														

RELEASE STATUS	RELEASE DATE
----------------	--------------

PART NO FOR TRAY PACKAGING	PART NO. FOR TUBE WITHOUT CAP PACKAGING	PART NO. FOR TUBE WITH CAP PACKAGING	PART NO. FOR TAPE & REEL WITHOUT CAP PACKAGING	PART NO. FOR TAPE & REEL WITH CAP PACKAGING	CKT SIZE	VOID POSITION	PLATING TYPE	DIMENSION				
								A	B	F	M	P
87914-3811	-----	-----	-----	-----	38	-----	1	48.26	45.72	10.92	5.84	2.79
87914-3821	-----	-----	-----	-----	38	-----	1	48.26	45.72	12.25	7.00	2.96
87914-3831	-----	-----	-----	-----	38	-----	1	48.26	45.72	13.38	6.09	5.00
87914-3812	-----	-----	-----	-----	38	-----	2	48.26	45.72	10.92	5.84	2.79
87914-3822	-----	-----	-----	-----	38	-----	2	48.26	45.72	12.25	7.00	2.96
87914-3832	-----	-----	-----	-----	38	-----	2	48.26	45.72	13.38	6.09	5.00
87914-3813	-----	-----	-----	-----	38	-----	3	48.26	45.72	10.92	5.84	2.79
87914-3823	-----	-----	-----	-----	38	-----	3	48.26	45.72	12.25	7.00	2.96
87914-3833	-----	-----	-----	-----	38	-----	3	48.26	45.72	13.38	6.09	5.00
87914-3814	-----	-----	-----	-----	38	-----	4	48.26	45.72	10.92	5.84	2.79
87914-3824	-----	-----	-----	-----	38	-----	4	48.26	45.72	12.25	7.00	2.96
87914-3834	-----	-----	-----	-----	38	-----	4	48.26	45.72	13.38	6.09	5.00
87914-3815	-----	-----	-----	-----	38	-----	5	48.26	45.72	10.92	5.84	2.79
87914-3825	-----	-----	-----	-----	38	-----	5	48.26	45.72	12.25	7.00	2.96
87914-3835	-----	-----	-----	-----	38	-----	5	48.26	45.72	13.38	6.09	5.00
87914-3816	-----	-----	-----	-----	38	-----	6	48.26	45.72	10.92	5.84	2.79
87914-3826	-----	-----	-----	-----	38	-----	6	48.26	45.72	12.25	7.00	2.96
87914-3836	-----	-----	-----	-----	38	-----	6	48.26	45.72	13.38	6.09	5.00

THIS DRAWING CONTAINS INFORMATION THAT IS PROPRIETARY TO MOLEX ELECTRONIC TECHNOLOGIES, LLC AND SHOULD NOT BE USED WITHOUT WRITTEN PERMISSION

MIGRATED TO NX 2017/01/18 EC NO: 114466 DRWN: PKH CHK'D: 2017/03/15 APP: ISHWARG	GENERAL TOLERANCES (UNLESS SPECIFIED)		DIMENSION UNITS		SCALE		 2.54MM PITCH DUAL ROW HEADER SINGLE WAFER, T/H PRODUCT CUSTOMER DRAWING	
			MM	INCH	NTS			
	4 PLACES	±	MM	INCH	DRWN BY	DATE		SERIES: 87914 MATERIAL NUMBER: SEE TABLE CUSTOMER: GENERAL MARKET DOCUMENT NUMBER: SD-87914-013 DOC TYPE: PSD DOC PART: 000 SHEET NUMBER: 24 OF 45
	3 PLACES	±			KCHO	2004/11/05		
	2 PLACES	± 0.2			CHK'D BY	DATE		
1 PLACES	±			PTLIM	2004/12/08			
0 PLACES	±			APPR BY	DATE			
		ANGULAR TOL = 3.0		MLONG	2010/09/06			
		DRAFT WHERE APPLICABLE MUST REMAIN WITHIN DIMENSIONS		DRAWING SIZE	THIRD ANGLE PROJECTION			
				A3				

RELEASE STATUS	RELEASE DATE
----------------	--------------

PART NO FOR TRAY PACKAGING	PART NO. FOR TUBE WITHOUT CAP PACKAGING	PART NO. FOR TUBE WITH CAP PACKAGING	PART NO. FOR TAPE & REEL WITHOUT CAP PACKAGING	PART NO. FOR TAPE & REEL WITH CAP PACKAGING	CKT SIZE	VOID POSITION	PLATING TYPE	DIMENSION				
								A	B	F	M	P
87914-4011	-----	-----	-----	-----	40	-----	1	50.80	48.26	10.92	5.84	2.79
87914-4021	-----	-----	-----	-----	40	-----	1	50.80	48.26	12.25	7.00	2.96
87914-4031	-----	-----	-----	-----	40	-----	1	50.80	48.26	13.38	6.09	5.00
87914-4012	-----	-----	-----	-----	40	-----	2	50.80	48.26	10.92	5.84	2.79
87914-4022	-----	-----	-----	-----	40	-----	2	50.80	48.26	12.25	7.00	2.96
87914-4032	-----	-----	-----	-----	40	-----	2	50.80	48.26	13.38	6.09	5.00
87914-4013	-----	-----	-----	-----	40	-----	3	50.80	48.26	10.92	5.84	2.79
87914-4023	-----	-----	-----	-----	40	-----	3	50.80	48.26	12.25	7.00	2.96
87914-4033	-----	-----	-----	-----	40	-----	3	50.80	48.26	13.38	6.09	5.00
87914-4014	-----	-----	-----	-----	40	-----	4	50.80	48.26	10.92	5.84	2.79
87914-4024	-----	-----	-----	-----	40	-----	4	50.80	48.26	12.25	7.00	2.96
87914-4034	-----	-----	-----	-----	40	-----	4	50.80	48.26	13.38	6.09	5.00
87914-4015	-----	-----	-----	-----	40	-----	5	50.80	48.26	10.92	5.84	2.79
87914-4025	-----	-----	-----	-----	40	-----	5	50.80	48.26	12.25	7.00	2.96
87914-4035	-----	-----	-----	-----	40	-----	5	50.80	48.26	13.38	6.09	5.00
87914-4016	-----	-----	-----	-----	40	-----	6	50.80	48.26	10.92	5.84	2.79
87914-4026	-----	-----	-----	-----	40	-----	6	50.80	48.26	12.25	7.00	2.96
87914-4036	-----	-----	-----	-----	40	-----	6	50.80	48.26	13.38	6.09	5.00

THIS DRAWING CONTAINS INFORMATION THAT IS PROPRIETARY TO MOLEX ELECTRONIC TECHNOLOGIES, LLC AND SHOULD NOT BE USED WITHOUT WRITTEN PERMISSION

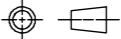
MIGRATED TO NX EC NO: 114466 DRWN: PKH CHK'D: REV APPR: ISHWARG	GENERAL TOLERANCES (UNLESS SPECIFIED)		DIMENSION UNITS		SCALE		 2.54MM PITCH DUAL ROW HEADER SINGLE WAFER, T/H PRODUCT CUSTOMER DRAWING	
			MM	INCH	MM	NTS		
	4 PLACES	±	±	DRWN BY	DATE			
	3 PLACES	±	±	KCHO	2004/11/05			
	2 PLACES	± 0.2	±	CHK'D BY	DATE			
	1 PLACES	±	±	PTLIM	2004/12/08			
0 PLACES	±	±	APPR BY	DATE				
ANGULAR TOL = 3.0		MLONG		2010/09/06		SERIES: 87914 MATERIAL NUMBER: SEE TABLE CUSTOMER: GENERAL MARKET		
DRAFT WHERE APPLICABLE MUST REMAIN WITHIN DIMENSIONS		DRAWING SIZE: A3		THIRD ANGLE PROJECTION				
								
RELEASE STATUS		RELEASE DATE		DOCUMENT NUMBER: SD-87914-013		DOC TYPE: PSD	DOC PART: 000	SHEET NUMBER: 25 OF 45

PART NO FOR TRAY PACKAGING	PART NO. FOR TUBE WITHOUT CAP PACKAGING	PART NO. FOR TUBE WITH CAP PACKAGING	PART NO. FOR TAPE & REEL WITHOUT CAP PACKAGING	PART NO. FOR TAPE & REEL WITH CAP PACKAGING	CKT SIZE	VOID POSITION	PLATING TYPE	DIMENSION				
								A	B	F	M	P
87914-4211	-----	-----	-----	-----	42	-----	1	53.34	50.80	10.92	5.84	2.79
87914-4221	-----	-----	-----	-----	42	-----	1	53.34	50.80	12.25	7.00	2.96
87914-4212	-----	-----	-----	-----	42	-----	2	53.34	50.80	10.92	5.84	2.79
87914-4222	-----	-----	-----	-----	42	-----	2	53.34	50.80	12.25	7.00	2.96
87914-4213	-----	-----	-----	-----	42	-----	3	53.34	50.80	10.92	5.84	2.79
87914-4223	-----	-----	-----	-----	42	-----	3	53.34	50.80	12.25	7.00	2.96
87914-4214	-----	-----	-----	-----	42	-----	4	53.34	50.80	10.92	5.84	2.79
87914-4224	-----	-----	-----	-----	42	-----	4	53.34	50.80	12.25	7.00	2.96
87914-4215	-----	-----	-----	-----	42	-----	5	53.34	50.80	10.92	5.84	2.79
87914-4225	-----	-----	-----	-----	42	-----	5	53.34	50.80	12.25	7.00	2.96
87914-4216	-----	-----	-----	-----	42	-----	6	53.34	50.80	10.92	5.84	2.79
87914-4226	-----	-----	-----	-----	42	-----	6	53.34	50.80	12.25	7.00	2.96

THIS DRAWING CONTAINS INFORMATION THAT IS PROPRIETARY TO MOLEX ELECTRONIC TECHNOLOGIES, LLC AND SHOULD NOT BE USED WITHOUT WRITTEN PERMISSION

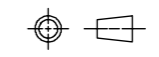
MIGRATED TO NX 2017/01/18 EC NO: 114466 DRWN: PKH CHK'D: 2017/03/15 APPR: ISHWARG	GENERAL TOLERANCES (UNLESS SPECIFIED)		DIMENSION UNITS		SCALE		 2.54MM PITCH DUAL ROW HEADER SINGLE WAFER, T/H PRODUCT CUSTOMER DRAWING	
			MM	INCH	MM	NTS		
	4 PLACES	±	MM	INCH	DRWN BY	DATE		
	3 PLACES	±			KCHO	2004/11/05		
	2 PLACES	± 0.2			CHK'D BY	DATE		
	1 PLACES	±			PTLIM	2004/12/08		
	0 PLACES	±			APPR BY	DATE		
			ANGULAR TOL = 3.0		MLONG	2010/09/06		
			DRAFT WHERE APPLICABLE MUST REMAIN WITHIN DIMENSIONS		DRAWING SIZE	THIRD ANGLE PROJECTION		
					A3			
REV	87914	DOC NUMBER	DOC TYPE	DOC PART	SHEET NUMBER			
D17		SD-87914-013	PSD	000	26 OF 45			

RELEASE STATUS	RELEASE DATE
----------------	--------------

PART NO FOR TRAY PACKAGING	PART NO. FOR TUBE WITHOUT CAP PACKAGING	PART NO. FOR TUBE WITH CAP PACKAGING	PART NO. FOR TAPE & REEL WITHOUT CAP PACKAGING	PART NO. FOR TAPE & REEL WITH CAP PACKAGING	CKT SIZE	VOID POSITION	PLATING TYPE	DIMENSION				
								A	B	F	M	P
87914-4411	-----	-----	-----	-----	44	-----	1	55.88	53.34	10.92	5.84	2.79
87914-4421	-----	-----	-----	-----	44	-----	1	55.88	53.34	12.25	7.00	2.96
87914-4412	-----	-----	-----	-----	44	-----	2	55.88	53.34	10.92	5.84	2.79
87914-4422	-----	-----	-----	-----	44	-----	2	55.88	53.34	12.25	7.00	2.96
87914-4413	-----	-----	-----	-----	44	-----	3	55.88	53.34	10.92	5.84	2.79
87914-4423	-----	-----	-----	-----	44	-----	3	55.88	53.34	12.25	7.00	2.96
87914-4414	-----	-----	-----	-----	44	-----	4	55.88	53.34	10.92	5.84	2.79
87914-4424	-----	-----	-----	-----	44	-----	4	55.88	53.34	12.25	7.00	2.96
87914-4415	-----	-----	-----	-----	44	-----	5	55.88	53.34	10.92	5.84	2.79
87914-4425	-----	-----	-----	-----	44	-----	5	55.88	53.34	12.25	7.00	2.96
87914-4416	-----	-----	-----	-----	44	-----	6	55.88	53.34	10.92	5.84	2.79
87914-4426	-----	-----	-----	-----	44	-----	6	55.88	53.34	12.25	7.00	2.96

THIS DRAWING CONTAINS INFORMATION THAT IS PROPRIETARY TO MOLEX ELECTRONIC TECHNOLOGIES, LLC AND SHOULD NOT BE USED WITHOUT WRITTEN PERMISSION

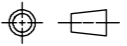
MIGRATED TO NX EC NO: 114466 DRWN: PKH CHK'D: ISHWARG APPR: ISHWARG	GENERAL TOLERANCES (UNLESS SPECIFIED)		DIMENSION UNITS		SCALE		 2.54MM PITCH DUAL ROW HEADER SINGLE WAFER, T/H PRODUCT CUSTOMER DRAWING		
			MM	INCH	MM	NTS			
	4 PLACES	±	±	DRWN BY	DATE				
	3 PLACES	±	±	KCHO	2004/11/05				
	2 PLACES	± 0.2	±	CHK'D BY	DATE				
1 PLACES	±	±	PTLIM	2004/12/08					
0 PLACES	±	±	APPR BY	DATE					
ANGULAR TOL = 3.0		MLONG		2010/09/06		SERIES MATERIAL NUMBER CUSTOMER			
DRAFT WHERE APPLICABLE MUST REMAIN WITHIN DIMENSIONS		DRAWING SIZE		THIRD ANGLE PROJECTION		87914	SEE TABLE	GENERAL MARKET	
A3				DOCUMENT NUMBER		SD-87914-013	DOC TYPE	DOC PART	SHEET NUMBER
D17						PSD	000	27 OF 45	

RELEASE STATUS	RELEASE DATE
----------------	--------------

PART NO FOR TRAY PACKAGING	PART NO. FOR TUBE WITHOUT CAP PACKAGING	PART NO. FOR TUBE WITH CAP PACKAGING	PART NO. FOR TAPE & REEL WITHOUT CAP PACKAGING	PART NO. FOR TAPE & REEL WITH CAP PACKAGING	CKT SIZE	VOID POSITION	PLATING TYPE	DIMENSION				
								A	B	F	M	P
87914-4611	-----	-----	-----	-----	46	-----	1	58.42	55.88	10.92	5.84	2.79
87914-4621	-----	-----	-----	-----	46	-----	1	58.42	55.88	12.25	7.00	2.96
87914-4612	-----	-----	-----	-----	46	-----	2	58.42	55.88	10.92	5.84	2.79
87914-4622	-----	-----	-----	-----	46	-----	2	58.42	55.88	12.25	7.00	2.96
87914-4613	-----	-----	-----	-----	46	-----	3	58.42	55.88	10.92	5.84	2.79
87914-4623	-----	-----	-----	-----	46	-----	3	58.42	55.88	12.25	7.00	2.96
87914-4614	-----	-----	-----	-----	46	-----	4	58.42	55.88	10.92	5.84	2.79
87914-4624	-----	-----	-----	-----	46	-----	4	58.42	55.88	12.25	7.00	2.96
87914-4615	-----	-----	-----	-----	46	-----	5	58.42	55.88	10.92	5.84	2.79
87914-4625	-----	-----	-----	-----	46	-----	5	58.42	55.88	12.25	7.00	2.96
87914-4616	-----	-----	-----	-----	46	-----	6	58.42	55.88	10.92	5.84	2.79
87914-4626	-----	-----	-----	-----	46	-----	6	58.42	55.88	12.25	7.00	2.96

THIS DRAWING CONTAINS INFORMATION THAT IS PROPRIETARY TO MOLEX ELECTRONIC TECHNOLOGIES, LLC AND SHOULD NOT BE USED WITHOUT WRITTEN PERMISSION

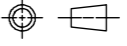
MIGRATED TO NX 2017/01/18 EC NO: 114466 DRWN: PKH CHK'D: 2017/03/15 APPR: ISHWARG	GENERAL TOLERANCES (UNLESS SPECIFIED)		DIMENSION UNITS	SCALE	 2.54MM PITCH DUAL ROW HEADER SINGLE WAFER, T/H PRODUCT CUSTOMER DRAWING		
			MM	NTS			
	4 PLACES	±	MM	INCH		DRWN BY	DATE
			KCHO	2004/11/05			
	3 PLACES	±				CHK'D BY	DATE
		PTLIM	2004/12/08				
2 PLACES	± 0.2			APPR BY	DATE		
		MLONG	2010/09/06				
1 PLACES	±			DRAWING SIZE			
		ANGULAR TOL = 3.0		THIRD ANGLE PROJECTION			
0 PLACES	±			A3			
DRAFT WHERE APPLICABLE MUST REMAIN WITHIN DIMENSIONS							

PART NO FOR TRAY PACKAGING	PART NO. FOR TUBE WITHOUT CAP PACKAGING	PART NO. FOR TUBE WITH CAP PACKAGING	PART NO. FOR TAPE & REEL WITHOUT CAP PACKAGING	PART NO. FOR TAPE & REEL WITH CAP PACKAGING	CKT SIZE	VOID POSITION	PLATING TYPE	DIMENSION				
								A	B	F	M	P
87914-4811	-----	-----	-----	-----	48	-----	1	60.96	58.42	10.92	5.84	2.79
87914-4821	-----	-----	-----	-----	48	-----	1	60.96	58.42	12.25	7.00	2.96
87914-4812	-----	-----	-----	-----	48	-----	2	60.96	58.42	10.92	5.84	2.79
87914-4822	-----	-----	-----	-----	48	-----	2	60.96	58.42	12.25	7.00	2.96
87914-4813	-----	-----	-----	-----	48	-----	3	60.96	58.42	10.92	5.84	2.79
87914-4823	-----	-----	-----	-----	48	-----	3	60.96	58.42	12.25	7.00	2.96
87914-4814	-----	-----	-----	-----	48	-----	4	60.96	58.42	10.92	5.84	2.79
87914-4824	-----	-----	-----	-----	48	-----	4	60.96	58.42	12.25	7.00	2.96
87914-4815	-----	-----	-----	-----	48	-----	5	60.96	58.42	10.92	5.84	2.79
87914-4825	-----	-----	-----	-----	48	-----	5	60.96	58.42	12.25	7.00	2.96
87914-4816	-----	-----	-----	-----	48	-----	6	60.96	58.42	10.92	5.84	2.79
87914-4826	-----	-----	-----	-----	48	-----	6	60.96	58.42	12.25	7.00	2.96

THIS DRAWING CONTAINS INFORMATION THAT IS PROPRIETARY TO MOLEX ELECTRONIC TECHNOLOGIES, LLC AND SHOULD NOT BE USED WITHOUT WRITTEN PERMISSION

MIGRATED TO NX EC NO: 114466 DRWN: PKH CHK'D: ISHWARG APPR: ISHWARG	2017/01/18		2017/03/15		GENERAL TOLERANCES (UNLESS SPECIFIED)		DIMENSION UNITS		SCALE		molex®		
							MM INCH		MM NTS				
	4 PLACES ±		±		KCHO		DATE		2004/11/05		2.54MM PITCH DUAL ROW HEADER SINGLE WAFER, T/H PRODUCT CUSTOMER DRAWING		
	3 PLACES ±		±		CHK'D BY		DATE		2004/12/08				
	2 PLACES ± 0.2		±		PTLIM		DATE		2010/09/06				
	1 PLACES ±		±		APPR BY		DATE						
0 PLACES ±		±		MLONG		DATE				SERIES: 87914 MATERIAL NUMBER: SEE TABLE CUSTOMER: GENERAL MARKET			
ANGULAR TOL = 3.0				DRAWING SIZE		THIRD ANGLE PROJECTION		A3		DOCUMENT NUMBER: SD-87914-013 DOC TYPE: PSD DOC PART: 000 SHEET NUMBER: 29 OF 45			
DRAFT WHERE APPLICABLE MUST REMAIN WITHIN DIMENSIONS													

RELEASE STATUS	RELEASE DATE
----------------	--------------

PART NO FOR TRAY PACKAGING	PART NO. FOR TUBE WITHOUT CAP PACKAGING	PART NO. FOR TUBE WITH CAP PACKAGING	PART NO. FOR TAPE & REEL WITHOUT CAP PACKAGING	PART NO. FOR TAPE & REEL WITH CAP PACKAGING	CKT SIZE	VOID POSITION	PLATING TYPE	DIMENSION				
								A	B	F	M	P
87914-5011	-----	-----	-----	-----	50	-----	1	63.50	60.96	10.92	5.84	2.79
87914-5021	-----	-----	-----	-----	50	-----	1	63.50	60.96	12.25	7.00	2.96
87914-5012	-----	-----	-----	-----	50	-----	2	63.50	60.96	10.92	5.84	2.79
87914-5022	-----	-----	-----	-----	50	-----	2	63.50	60.96	12.25	7.00	2.96
87914-5013	-----	-----	-----	-----	50	-----	3	63.50	60.96	10.92	5.84	2.79
87914-5023	-----	-----	-----	-----	50	-----	3	63.50	60.96	12.25	7.00	2.96
87914-5014	-----	-----	-----	-----	50	-----	4	63.50	60.96	10.92	5.84	2.79
87914-5024	-----	-----	-----	-----	50	-----	4	63.50	60.96	12.25	7.00	2.96
87914-5015	-----	-----	-----	-----	50	-----	5	63.50	60.96	10.92	5.84	2.79
87914-5025	-----	-----	-----	-----	50	-----	5	63.50	60.96	12.25	7.00	2.96
87914-5016	-----	-----	-----	-----	50	-----	6	63.50	60.96	10.92	5.84	2.79
87914-5026	-----	-----	-----	-----	50	-----	6	63.50	60.96	12.25	7.00	2.96
87914-0002	-----	-----	-----	-----	50	-----	8	63.50	60.96	18.54	11.58	4.47

THIS DRAWING CONTAINS INFORMATION THAT IS PROPRIETARY TO MOLEX ELECTRONIC TECHNOLOGIES, LLC AND SHOULD NOT BE USED WITHOUT WRITTEN PERMISSION

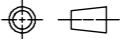
MIGRATED TO NX EC NO: 114466 DRWN: PKH CHK'D: APPR: ISHWARG	2017/01/18	GENERAL TOLERANCES (UNLESS SPECIFIED)		DIMENSION UNITS		SCALE		 2.54MM PITCH DUAL ROW HEADER SINGLE WAFER, T/H			
	2017/03/15	MM	INCH	MM	NTS						
	4 PLACES	±	±	DRWN BY	DATE		PRODUCT CUSTOMER DRAWING				
	3 PLACES	±	±	KCHO	2004/11/05						
	2 PLACES	± 0.2	±	CHK'D BY	DATE		SERIES: 87914 MATERIAL NUMBER: SEE TABLE CUSTOMER: GENERAL MARKET				
	1 PLACES	±	±	PTLIM	2004/12/08						
	0 PLACES	±	±	APPR BY	DATE		DOCUMENT NUMBER: SD-87914-013 DOC TYPE: PSD DOC PART: 000 SHEET NUMBER: 30 OF 45				
	ANGULAR TOL = 3.0			MLONG	2010/09/06						
	DRAFT WHERE APPLICABLE MUST REMAIN WITHIN DIMENSIONS			DRAWING SIZE	THIRD ANGLE PROJECTION						
				A3							

RELEASE STATUS	RELEASE DATE
----------------	--------------

PART NO FOR BULK PACKAGING	PART NO. FOR TUBE WITHOUT CAP PACKAGING	PART NO. FOR TUBE WITH CAP PACKAGING	PART NO. FOR TAPE & REEL WITHOUT CAP PACKAGING	PART NO. FOR TAPE & REEL WITH CAP PACKAGING	CKT SIZE	VOID POSITION	PLATING TYPE	DIMENSION				
								A	B	F	M	P
87914-5211	-----	-----	-----	-----	52	-----	1	66.04	63.50	10.92	5.84	2.79
87914-5221	-----	-----	-----	-----	52	-----	1	66.04	63.50	12.25	7.00	2.96
87914-5212	-----	-----	-----	-----	52	-----	2	66.04	63.50	10.92	5.84	2.79
87914-5222	-----	-----	-----	-----	52	-----	2	66.04	63.50	12.25	7.00	2.96
87914-5213	-----	-----	-----	-----	52	-----	3	66.04	63.50	10.92	5.84	2.79
87914-5223	-----	-----	-----	-----	52	-----	3	66.04	63.50	12.25	7.00	2.96
87914-5214	-----	-----	-----	-----	52	-----	4	66.04	63.50	10.92	5.84	2.79
87914-5224	-----	-----	-----	-----	52	-----	4	66.04	63.50	12.25	7.00	2.96
87914-5215	-----	-----	-----	-----	52	-----	5	66.04	63.50	10.92	5.84	2.79
87914-5225	-----	-----	-----	-----	52	-----	5	66.04	63.50	12.25	7.00	2.96
87914-5216	-----	-----	-----	-----	52	-----	6	66.04	63.50	10.92	5.84	2.79
87914-5226	-----	-----	-----	-----	52	-----	6	66.04	63.50	12.25	7.00	2.96

THIS DRAWING CONTAINS INFORMATION THAT IS PROPRIETARY TO MOLEX ELECTRONIC TECHNOLOGIES, LLC AND SHOULD NOT BE USED WITHOUT WRITTEN PERMISSION

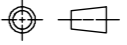
MIGRATED TO NX EC NO: 114466 DRWN: PKH CHK'D: ISHWARG APPR: ISHWARG REV:	2017/01/18	GENERAL TOLERANCES (UNLESS SPECIFIED)		DIMENSION UNITS		SCALE					
	2017/03/15	MM	INCH	MM	NTS						
	4 PLACES	±	±	DRWN BY	DATE		2.54MM PITCH DUAL ROW HEADER SINGLE WAFER, T/H				
	3 PLACES	±	±	KCHO	2004/11/05						
	2 PLACES	± 0.2	±	CHK'D BY	DATE						
	1 PLACES	±	±	PTLIM	2004/12/08		PRODUCT CUSTOMER DRAWING				
	0 PLACES	±	±	APPR BY	DATE						
	ANGULAR TOL = 3.0			MLONG	2010/09/06		SERIES	MATERIAL NUMBER	CUSTOMER		
	DRAFT WHERE APPLICABLE MUST REMAIN WITHIN DIMENSIONS			DRAWING SIZE	THIRD ANGLE PROJECTION		87914	SEE TABLE	GENERAL MARKET		
				A3			DOCUMENT NUMBER	DOC TYPE	DOC PART	SHEET NUMBER	
						SD-87914-013	PSD	000	31 OF 45		

RELEASE STATUS	RELEASE DATE
----------------	--------------

PART NO FOR BULK PACKAGING	PART NO. FOR TUBE WITHOUT CAP PACKAGING	PART NO. FOR TUBE WITH CAP PACKAGING	PART NO. FOR TAPE & REEL WITHOUT CAP PACKAGING	PART NO. FOR TAPE & REEL WITH CAP PACKAGING	CKT SIZE	VOID POSITION	PLATING TYPE	DIMENSION				
								A	B	F	M	P
87914-5411	-----	-----	-----	-----	54	-----	1	68.58	66.04	10.92	5.84	2.79
87914-5421	-----	-----	-----	-----	54	-----	1	68.58	66.04	12.25	7.00	2.96
87914-5412	-----	-----	-----	-----	54	-----	2	68.58	66.04	10.92	5.84	2.79
87914-5422	-----	-----	-----	-----	54	-----	2	68.58	66.04	12.25	7.00	2.96
87914-5413	-----	-----	-----	-----	54	-----	3	68.58	66.04	10.92	5.84	2.79
87914-5423	-----	-----	-----	-----	54	-----	3	68.58	66.04	12.25	7.00	2.96
87914-5414	-----	-----	-----	-----	54	-----	4	68.58	66.04	10.92	5.84	2.79
87914-5424	-----	-----	-----	-----	54	-----	4	68.58	66.04	12.25	7.00	2.96
87914-5415	-----	-----	-----	-----	54	-----	5	68.58	66.04	10.92	5.84	2.79
87914-5425	-----	-----	-----	-----	54	-----	5	68.58	66.04	12.25	7.00	2.96
87914-5416	-----	-----	-----	-----	54	-----	6	68.58	66.04	10.92	5.84	2.79
87914-5426	-----	-----	-----	-----	54	-----	6	68.58	66.04	12.25	7.00	2.96

THIS DRAWING CONTAINS INFORMATION THAT IS PROPRIETARY TO MOLEX ELECTRONIC TECHNOLOGIES, LLC AND SHOULD NOT BE USED WITHOUT WRITTEN PERMISSION

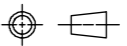
MIGRATED TO NX EC NO: 114466 DRWN: PKH CHK'D: ISHWARG APPR: ISHWARG REV:	GENERAL TOLERANCES (UNLESS SPECIFIED)		DIMENSION UNITS		SCALE						
			MM	INCH	MM	NTS					
	4 PLACES ±		MM	INCH	DRWN BY	DATE	2.54MM PITCH DUAL ROW HEADER SINGLE WAFER, T/H				
	3 PLACES ±				KCHO	2004/11/05					
	2 PLACES ± 0.2				CHK'D BY	DATE					
	1 PLACES ±				PTLIM	2004/12/08					
	0 PLACES ±				APPR BY	DATE	PRODUCT CUSTOMER DRAWING				
					MLONG	2010/09/06	SERIES	MATERIAL NUMBER	CUSTOMER		
	ANGULAR TOL = 3.0				DRAWING SIZE	THIRD ANGLE PROJECTION	87914	SEE TABLE	GENERAL MARKET		
	DRAFT WHERE APPLICABLE MUST REMAIN WITHIN DIMENSIONS				A3		DOCUMENT NUMBER		DOC TYPE	DOC PART	SHEET NUMBER
						SD-87914-013		PSD	000	32 OF 45	

RELEASE STATUS	RELEASE DATE
----------------	--------------

PART NO FOR BULK PACKAGING	PART NO. FOR TUBE WITHOUT CAP PACKAGING	PART NO. FOR TUBE WITH CAP PACKAGING	PART NO. FOR TAPE & REEL WITHOUT CAP PACKAGING	PART NO. FOR TAPE & REEL WITH CAP PACKAGING	CKT SIZE	VOID POSITION	PLATING TYPE	DIMENSION				
								A	B	F	M	P
87914-5611	-----	-----	-----	-----	56	-----	1	71.12	68.58	10.92	5.84	2.79
87914-5621	-----	-----	-----	-----	56	-----	1	71.12	68.58	12.25	7.00	2.96
87914-5612	-----	-----	-----	-----	56	-----	2	71.12	68.58	10.92	5.84	2.79
87914-5622	-----	-----	-----	-----	56	-----	2	71.12	68.58	12.25	7.00	2.96
87914-5613	-----	-----	-----	-----	56	-----	3	71.12	68.58	10.92	5.84	2.79
87914-5623	-----	-----	-----	-----	56	-----	3	71.12	68.58	12.25	7.00	2.96
87914-5614	-----	-----	-----	-----	56	-----	4	71.12	68.58	10.92	5.84	2.79
87914-5624	-----	-----	-----	-----	56	-----	4	71.12	68.58	12.25	7.00	2.96
87914-5615	-----	-----	-----	-----	56	-----	5	71.12	68.58	10.92	5.84	2.79
87914-5625	-----	-----	-----	-----	56	-----	5	71.12	68.58	12.25	7.00	2.96
87914-5616	-----	-----	-----	-----	56	-----	6	71.12	68.58	10.92	5.84	2.79
87914-5626	-----	-----	-----	-----	56	-----	6	71.12	68.58	12.25	7.00	2.96

THIS DRAWING CONTAINS INFORMATION THAT IS PROPRIETARY TO MOLEX ELECTRONIC TECHNOLOGIES, LLC AND SHOULD NOT BE USED WITHOUT WRITTEN PERMISSION

MIGRATED TO NX 2017/01/18 EC NO: 114466 DRWN: PKH CHK'D: REV	2017/03/15 APP: ISHWARG	GENERAL TOLERANCES (UNLESS SPECIFIED)		DIMENSION UNITS	SCALE
				MM	NTS
		4 PLACES ±	±	DRWN BY	DATE
				KCHO	2004/11/05
		3 PLACES ±	±	CHK'D BY	DATE
				PTLIM	2004/12/08
2 PLACES ± 0.2	±	APPR BY	DATE		
		MLONG	2010/09/06		
1 PLACES ±	±	DRAWING SIZE		THIRD ANGLE PROJECTION	
		A3			
0 PLACES ±	±	ANGULAR TOL = 3.0			
		DRAFT WHERE APPLICABLE MUST REMAIN WITHIN DIMENSIONS			

2.54MM PITCH
DUAL ROW HEADER SINGLE WAFER, T/H

PRODUCT CUSTOMER DRAWING

SERIES	MATERIAL NUMBER	CUSTOMER
87914	SEE TABLE	GENERAL MARKET
DOCUMENT NUMBER	DOC TYPE	DOC PART
SD-87914-013	PSD	000
SHEET NUMBER		
33 OF 45		

RELEASE STATUS	RELEASE DATE
----------------	--------------

PART NO FOR BULK PACKAGING	PART NO. FOR TUBE WITHOUT CAP PACKAGING	PART NO. FOR TUBE WITH CAP PACKAGING	PART NO. FOR TAPE & REEL WITHOUT CAP PACKAGING	PART NO. FOR TAPE & REEL WITH CAP PACKAGING	CKT SIZE	VOID POSITION	PLATING TYPE	DIMENSION				
								A	B	F	M	P
87914-5811	-----	-----	-----	-----	58	-----	1	73.66	71.12	10.92	5.84	2.79
87914-5821	-----	-----	-----	-----	58	-----	1	73.66	71.12	12.25	7.00	2.96
87914-5812	-----	-----	-----	-----	58	-----	2	73.66	71.12	10.92	5.84	2.79
87914-5822	-----	-----	-----	-----	58	-----	2	73.66	71.12	12.25	7.00	2.96
87914-5813	-----	-----	-----	-----	58	-----	3	73.66	71.12	10.92	5.84	2.79
87914-5823	-----	-----	-----	-----	58	-----	3	73.66	71.12	12.25	7.00	2.96
87914-5814	-----	-----	-----	-----	58	-----	4	73.66	71.12	10.92	5.84	2.79
87914-5824	-----	-----	-----	-----	58	-----	4	73.66	71.12	12.25	7.00	2.96
87914-5815	-----	-----	-----	-----	58	-----	5	73.66	71.12	10.92	5.84	2.79
87914-5825	-----	-----	-----	-----	58	-----	5	73.66	71.12	12.25	7.00	2.96
87914-5816	-----	-----	-----	-----	58	-----	6	73.66	71.12	10.92	5.84	2.79
87914-5826	-----	-----	-----	-----	58	-----	6	73.66	71.12	12.25	7.00	2.96

THIS DRAWING CONTAINS INFORMATION THAT IS PROPRIETARY TO MOLEX ELECTRONIC TECHNOLOGIES, LLC AND SHOULD NOT BE USED WITHOUT WRITTEN PERMISSION

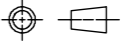
MIGRATED TO NX EC NO: 114466 DRWN: PKH CHK'D: APPR: ISHWARG	GENERAL TOLERANCES (UNLESS SPECIFIED)		DIMENSION UNITS		SCALE		 2.54MM PITCH DUAL ROW HEADER SINGLE WAFER, T/H PRODUCT CUSTOMER DRAWING	
			MM	INCH	MM	NTS		
	4 PLACES	±			DRWN BY	DATE		
	3 PLACES	±			KCHO	2004/11/05		
	2 PLACES	± 0.2			CHK'D BY	DATE		
	1 PLACES	±			PTLIM	2004/12/08		
	0 PLACES	±			APPR BY	DATE		
ANGULAR TOL = 3.0		DRAWING SIZE		THIRD ANGLE PROJECTION				
DRAFT WHERE APPLICABLE MUST REMAIN WITHIN DIMENSIONS		A3						
SERIES			MATERIAL NUMBER			CUSTOMER		
87914			SEE TABLE			GENERAL MARKET		
DOCUMENT NUMBER				DOC TYPE		DOC PART	SHEET NUMBER	
SD-87914-013				PSD		000	34 OF 45	

RELEASE STATUS	RELEASE DATE
----------------	--------------

PART NO FOR BULK PACKAGING	PART NO. FOR TUBE WITHOUT CAP PACKAGING	PART NO. FOR TUBE WITH CAP PACKAGING	PART NO. FOR TAPE & REEL WITHOUT CAP PACKAGING	PART NO. FOR TAPE & REEL WITH CAP PACKAGING	CKT SIZE	VOID POSITION	PLATING TYPE	DIMENSION				
								A	B	F	M	P
87914-6011	-----	-----	-----	-----	60	-----	1	76.20	73.66	10.92	5.84	2.79
87914-6021	-----	-----	-----	-----	60	-----	1	76.20	73.66	12.25	7.00	2.96
87914-6012	-----	-----	-----	-----	60	-----	2	76.20	73.66	10.92	5.84	2.79
87914-6022	-----	-----	-----	-----	60	-----	2	76.20	73.66	12.25	7.00	2.96
87914-6013	-----	-----	-----	-----	60	-----	3	76.20	73.66	10.92	5.84	2.79
87914-6023	-----	-----	-----	-----	60	-----	3	76.20	73.66	12.25	7.00	2.96
87914-6014	-----	-----	-----	-----	60	-----	4	76.20	73.66	10.92	5.84	2.79
87914-6024	-----	-----	-----	-----	60	-----	4	76.20	73.66	12.25	7.00	2.96
87914-6015	-----	-----	-----	-----	60	-----	5	76.20	73.66	10.92	5.84	2.79
87914-6025	-----	-----	-----	-----	60	-----	5	76.20	73.66	12.25	7.00	2.96
87914-6016	-----	-----	-----	-----	60	-----	6	76.20	73.66	10.92	5.84	2.79
87914-6026	-----	-----	-----	-----	60	-----	6	76.20	73.66	12.25	7.00	2.96

THIS DRAWING CONTAINS INFORMATION THAT IS PROPRIETARY TO MOLEX ELECTRONIC TECHNOLOGIES, LLC AND SHOULD NOT BE USED WITHOUT WRITTEN PERMISSION

MIGRATED TO NX 2017/01/18 EC NO: 114466 DRWN: PKH CHK'D: 2017/03/15 APPR: ISHWARG	GENERAL TOLERANCES (UNLESS SPECIFIED)		DIMENSION UNITS	SCALE		
			MM	NTS		
			MM	INCH		
	4 PLACES	±	DRWN BY: KCHO			DATE: 2004/11/05
	3 PLACES	±	CHK'D BY: PTLIM			DATE: 2004/12/08
	2 PLACES	± 0.2	APPR BY: MLONG			DATE: 2010/09/06
	1 PLACES	±	DRAWING SIZE: A3	THIRD ANGLE PROJECTION		
	0 PLACES	±	DRAFT WHERE APPLICABLE MUST REMAIN WITHIN DIMENSIONS			
	ANGULAR TOL = 3.0					
	SERIES: 87914		MATERIAL NUMBER: SEE TABLE			CUSTOMER: GENERAL MARKET
DOCUMENT NUMBER: SD-87914-013		DOC TYPE: PSD	DOC PART: 000	SHEET NUMBER: 35 OF 45		

2.54MM PITCH
DUAL ROW HEADER SINGLE WAFER, T/H

PRODUCT CUSTOMER DRAWING

RELEASE STATUS	RELEASE DATE
----------------	--------------

PART NO FOR BULK PACKAGING	PART NO. FOR TUBE WITHOUT CAP PACKAGING	PART NO. FOR TUBE WITH CAP PACKAGING	PART NO. FOR TAPE & REEL WITHOUT CAP PACKAGING	PART NO. FOR TAPE & REEL WITH CAP PACKAGING	CKT SIZE	VOID POSITION	PLATING TYPE	DIMENSION				
								A	B	F	M	P
87914-6211	-----	-----	-----	-----	62	-----	1	78.74	76.20	10.92	5.84	2.79
87914-6221	-----	-----	-----	-----	62	-----	1	78.74	76.20	12.25	7.00	2.96
87914-6212	-----	-----	-----	-----	62	-----	2	78.74	76.20	10.92	5.84	2.79
87914-6222	-----	-----	-----	-----	62	-----	2	78.74	76.20	12.25	7.00	2.96
87914-6213	-----	-----	-----	-----	62	-----	3	78.74	76.20	10.92	5.84	2.79
87914-6223	-----	-----	-----	-----	62	-----	3	78.74	76.20	12.25	7.00	2.96
87914-6214	-----	-----	-----	-----	62	-----	4	78.74	76.20	10.92	5.84	2.79
87914-6224	-----	-----	-----	-----	62	-----	4	78.74	76.20	12.25	7.00	2.96
87914-6215	-----	-----	-----	-----	62	-----	5	78.74	76.20	10.92	5.84	2.79
87914-6225	-----	-----	-----	-----	62	-----	5	78.74	76.20	12.25	7.00	2.96
87914-6216	-----	-----	-----	-----	62	-----	6	78.74	76.20	10.92	5.84	2.79
87914-6226	-----	-----	-----	-----	62	-----	6	78.74	76.20	12.25	7.00	2.96

THIS DRAWING CONTAINS INFORMATION THAT IS PROPRIETARY TO MOLEX ELECTRONIC TECHNOLOGIES, LLC AND SHOULD NOT BE USED WITHOUT WRITTEN PERMISSION

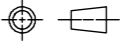
MIGRATED TO NX EC NO: 114466 DRWN: PKH CHK'D: APPR: ISHWARG	2017/01/18	GENERAL TOLERANCES (UNLESS SPECIFIED)		DIMENSION UNITS		SCALE		 2.54MM PITCH DUAL ROW HEADER SINGLE WAFER, T/H				
	2017/03/15	MM	INCH	MM	NTS	DRWN BY	DATE					
	4 PLACES	±	±	KCHO		2004/11/05		PRODUCT CUSTOMER DRAWING				
	3 PLACES	±	±	CHK'D BY		DATE						
	2 PLACES	± 0.2	±	PTLIM		2004/12/08		SERIES: 87914 MATERIAL NUMBER: SEE TABLE CUSTOMER: GENERAL MARKET				
	1 PLACES	±	±	APPR BY		DATE						
	0 PLACES	±	±	MLONG		2010/09/06		DOCUMENT NUMBER: SD-87914-013 DOC TYPE: PSD DOC PART: 000 SHEET NUMBER: 36 OF 45				
	ANGULAR TOL = 3.0		DRAWING SIZE		THIRD ANGLE PROJECTION							
	DRAFT WHERE APPLICABLE MUST REMAIN WITHIN DIMENSIONS		A3									

RELEASE STATUS	RELEASE DATE
----------------	--------------

PART NO FOR BULK PACKAGING	PART NO. FOR TUBE WITHOUT CAP PACKAGING	PART NO. FOR TUBE WITH CAP PACKAGING	PART NO. FOR TAPE & REEL WITHOUT CAP PACKAGING	PART NO. FOR TAPE & REEL WITH CAP PACKAGING	CKT SIZE	VOID POSITION	PLATING TYPE	DIMENSION				
								A	B	F	M	P
87914-6411	-----	-----	-----	-----	64	-----	1	81.28	78.74	10.92	5.84	2.79
87914-6421	-----	-----	-----	-----	64	-----	1	81.28	78.74	12.25	7.00	2.96
87914-6412	-----	-----	-----	-----	64	-----	2	81.28	78.74	10.92	5.84	2.79
87914-6422	-----	-----	-----	-----	64	-----	2	81.28	78.74	12.25	7.00	2.96
87914-6413	-----	-----	-----	-----	64	-----	3	81.28	78.74	10.92	5.84	2.79
87914-6423	-----	-----	-----	-----	64	-----	3	81.28	78.74	12.25	7.00	2.96
87914-6414	-----	-----	-----	-----	64	-----	4	81.28	78.74	10.92	5.84	2.79
87914-6424	-----	-----	-----	-----	64	-----	4	81.28	78.74	12.25	7.00	2.96
87914-6415	-----	-----	-----	-----	64	-----	5	81.28	78.74	10.92	5.84	2.79
87914-6425	-----	-----	-----	-----	64	-----	5	81.28	78.74	12.25	7.00	2.96
87914-6416	-----	-----	-----	-----	64	-----	6	81.28	78.74	10.92	5.84	2.79
87914-6426	-----	-----	-----	-----	64	-----	6	81.28	78.74	12.25	7.00	2.96

THIS DRAWING CONTAINS INFORMATION THAT IS PROPRIETARY TO MOLEX ELECTRONIC TECHNOLOGIES, LLC AND SHOULD NOT BE USED WITHOUT WRITTEN PERMISSION

MIGRATED TO NX EC NO: 114466 DRWN: PKH CHK'D: ISHWARG APPR: ISHWARG	2017/01/18		2017/03/15		GENERAL TOLERANCES (UNLESS SPECIFIED)		DIMENSION UNITS		SCALE				
							MM INCH		MM NTS				
	4 PLACES ±		±		KCHO		DATE		2004/11/05		2.54MM PITCH DUAL ROW HEADER SINGLE WAFER, T/H		
	3 PLACES ±		±		CHK'D BY		DATE		PTLIM 2004/12/08				
	2 PLACES ± 0.2		±		APPR BY		DATE		MLONG 2010/09/06		PRODUCT CUSTOMER DRAWING		
	1 PLACES ±		±		DRAWING SIZE		THIRD ANGLE PROJECTION		A3				
	0 PLACES ±		±		ANGULAR TOL = 3.0		DRAFT WHERE APPLICABLE MUST REMAIN WITHIN DIMENSIONS				SERIES: 87914 MATERIAL NUMBER: SEE TABLE CUSTOMER: GENERAL MARKET		
													DOCUMENT NUMBER: SD-87914-013 DOC TYPE: PSD DOC PART: 000 SHEET NUMBER: 37 OF 45

RELEASE STATUS	RELEASE DATE
----------------	--------------

PART NO FOR BULK PACKAGING	PART NO. FOR TUBE WITHOUT CAP PACKAGING	PART NO. FOR TUBE WITH CAP PACKAGING	PART NO. FOR TAPE & REEL WITHOUT CAP PACKAGING	PART NO. FOR TAPE & REEL WITH CAP PACKAGING	CKT SIZE	VOID POSITION	PLATING TYPE	DIMENSION				
								A	B	F	M	P
87914-6611	-----	-----	-----	-----	66	-----	1	83.82	81.28	10.92	5.84	2.79
87914-6621	-----	-----	-----	-----	66	-----	1	83.82	81.28	12.25	7.00	2.96
87914-6612	-----	-----	-----	-----	66	-----	2	83.82	81.28	10.92	5.84	2.79
87914-6622	-----	-----	-----	-----	66	-----	2	83.82	81.28	12.25	7.00	2.96
87914-6613	-----	-----	-----	-----	66	-----	3	83.82	81.28	10.92	5.84	2.79
87914-6623	-----	-----	-----	-----	66	-----	3	83.82	81.28	12.25	7.00	2.96
87914-6614	-----	-----	-----	-----	66	-----	4	83.82	81.28	10.92	5.84	2.79
87914-6624	-----	-----	-----	-----	66	-----	4	83.82	81.28	12.25	7.00	2.96
87914-6615	-----	-----	-----	-----	66	-----	5	83.82	81.28	10.92	5.84	2.79
87914-6625	-----	-----	-----	-----	66	-----	5	83.82	81.28	12.25	7.00	2.96
87914-6616	-----	-----	-----	-----	66	-----	6	83.82	81.28	10.92	5.84	2.79
87914-6626	-----	-----	-----	-----	66	-----	6	83.82	81.28	12.25	7.00	2.96

THIS DRAWING CONTAINS INFORMATION THAT IS PROPRIETARY TO MOLEX ELECTRONIC TECHNOLOGIES, LLC AND SHOULD NOT BE USED WITHOUT WRITTEN PERMISSION

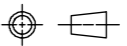
MIGRATED TO NX EC NO: 114466 DRWN: PKH CHK'D: ISHWARG REV APPR: 2017/01/18 2017/03/15	GENERAL TOLERANCES (UNLESS SPECIFIED)		DIMENSION UNITS		SCALE		 2.54MM PITCH DUAL ROW HEADER SINGLE WAFER, T/H PRODUCT CUSTOMER DRAWING	
			MM	INCH	MM	NTS		
	4 PLACES	±		±	DRWN BY	DATE		
	3 PLACES	±		±	KCHO	2004/11/05		
	2 PLACES	± 0.2		±	CHK'D BY	DATE		
1 PLACES	±		±	PTLIM	2004/12/08			
0 PLACES	±		±	APPR BY	DATE			
		ANGULAR TOL = 3.0		MLONG	2010/09/06			
		DRAFT WHERE APPLICABLE MUST REMAIN WITHIN DIMENSIONS		DRAWING SIZE	THIRD ANGLE PROJECTION			
				A3				

SERIES	MATERIAL NUMBER	CUSTOMER
87914	SEE TABLE	GENERAL MARKET
DOCUMENT NUMBER	DOC TYPE	DOC PART
SD-87914-013	PSD	000
SHEET NUMBER		
38 OF 45		

RELEASE STATUS	RELEASE DATE
----------------	--------------

PART NO FOR BULK PACKAGING	PART NO. FOR TUBE WITHOUT CAP PACKAGING	PART NO. FOR TUBE WITH CAP PACKAGING	PART NO. FOR TAPE & REEL WITHOUT CAP PACKAGING	PART NO. FOR TAPE & REEL WITH CAP PACKAGING	CKT SIZE	VOID POSITION	PLATING TYPE	DIMENSION				
								A	B	F	M	P
87914-6811	-----	-----	-----	-----	68	-----	1	86.36	83.82	10.92	5.84	2.79
87914-6821	-----	-----	-----	-----	68	-----	1	86.36	83.82	12.25	7.00	2.96
87914-6812	-----	-----	-----	-----	68	-----	2	86.36	83.82	10.92	5.84	2.79
87914-6822	-----	-----	-----	-----	68	-----	2	86.36	83.82	12.25	7.00	2.96
87914-6813	-----	-----	-----	-----	68	-----	3	86.36	83.82	10.92	5.84	2.79
87914-6823	-----	-----	-----	-----	68	-----	3	86.36	83.82	12.25	7.00	2.96
87914-6814	-----	-----	-----	-----	68	-----	4	86.36	83.82	10.92	5.84	2.79
87914-6824	-----	-----	-----	-----	68	-----	4	86.36	83.82	12.25	7.00	2.96
87914-6815	-----	-----	-----	-----	68	-----	5	86.36	83.82	10.92	5.84	2.79
87914-6825	-----	-----	-----	-----	68	-----	5	86.36	83.82	12.25	7.00	2.96
87914-6816	-----	-----	-----	-----	68	-----	6	86.36	83.82	10.92	5.84	2.79
87914-6826	-----	-----	-----	-----	68	-----	6	86.36	83.82	12.25	7.00	2.96

THIS DRAWING CONTAINS INFORMATION THAT IS PROPRIETARY TO MOLEX ELECTRONIC TECHNOLOGIES, LLC AND SHOULD NOT BE USED WITHOUT WRITTEN PERMISSION

MIGRATED TO NX 2017/01/18 EC NO: 114466 DRWN: PKH CHK'D: 2017/03/15 APPR: ISHWARG	GENERAL TOLERANCES (UNLESS SPECIFIED)		DIMENSION UNITS		SCALE					
			MM	INCH	MM	NTS				
	4 PLACES	±		±	DRWN BY	DATE		2.54MM PITCH DUAL ROW HEADER SINGLE WAFER, T/H		
	3 PLACES	±		±	KCHO	2004/11/05				
	2 PLACES	± 0.2		±	CHK'D BY	DATE				
	1 PLACES	±		±	PTLIM	2004/12/08		PRODUCT CUSTOMER DRAWING		
	0 PLACES	±		±	APPR BY	DATE				
	ANGULAR TOL = 3.0				MLONG	2010/09/06		SERIES	MATERIAL NUMBER	CUSTOMER
	DRAFT WHERE APPLICABLE MUST REMAIN WITHIN DIMENSIONS				DRAWING SIZE	THIRD ANGLE PROJECTION		87914	SEE TABLE	GENERAL MARKET
					A3			DOCUMENT NUMBER	DOC TYPE	DOC PART
							SD-87914-013	PSD	000	39 OF 45

RELEASE STATUS	RELEASE DATE
----------------	--------------

PART NO FOR BULK PACKAGING	PART NO. FOR TUBE WITHOUT CAP PACKAGING	PART NO. FOR TUBE WITH CAP PACKAGING	PART NO. FOR TAPE & REEL WITHOUT CAP PACKAGING	PART NO. FOR TAPE & REEL WITH CAP PACKAGING	CKT SIZE	VOID POSITION	PLATING TYPE	DIMENSION				
								A	B	F	M	P
87914-7011	-----	-----	-----	-----	70	-----	1	88.90	86.36	10.92	5.84	2.79
87914-7021	-----	-----	-----	-----	70	-----	1	88.90	86.36	12.25	7.00	2.96
87914-7012	-----	-----	-----	-----	70	-----	2	88.90	86.36	10.92	5.84	2.79
87914-7022	-----	-----	-----	-----	70	-----	2	88.90	86.36	12.25	7.00	2.96
87914-7013	-----	-----	-----	-----	70	-----	3	88.90	86.36	10.92	5.84	2.79
87914-7023	-----	-----	-----	-----	70	-----	3	88.90	86.36	12.25	7.00	2.96
87914-7014	-----	-----	-----	-----	70	-----	4	88.90	86.36	10.92	5.84	2.79
87914-7024	-----	-----	-----	-----	70	-----	4	88.90	86.36	12.25	7.00	2.96
87914-7015	-----	-----	-----	-----	70	-----	5	88.90	86.36	10.92	5.84	2.79
87914-7025	-----	-----	-----	-----	70	-----	5	88.90	86.36	12.25	7.00	2.96
87914-7016	-----	-----	-----	-----	70	-----	6	88.90	86.36	10.92	5.84	2.79
87914-7026	-----	-----	-----	-----	70	-----	6	88.90	86.36	12.25	7.00	2.96

THIS DRAWING CONTAINS INFORMATION THAT IS PROPRIETARY TO MOLEX ELECTRONIC TECHNOLOGIES, LLC AND SHOULD NOT BE USED WITHOUT WRITTEN PERMISSION

MIGRATED TO NX EC NO: 114466 DRWN: PKH CHK'D: APPR: ISHWARG 2017/01/18 2017/03/15	GENERAL TOLERANCES (UNLESS SPECIFIED)		DIMENSION UNITS		SCALE	
			MM	INCH	MM	NTS
	4 PLACES	±	±	DRWN BY	DATE	
			KCHO	2004/11/05		
	3 PLACES	±	±	CHK'D BY	DATE	
			PTLIM	2004/12/08		
	2 PLACES	± 0.2	±	APPR BY	DATE	
			MLONG	2010/09/06		
	1 PLACES	±	±	DRAWING SIZE	THIRD ANGLE PROJECTION	
			A3			
		ANGULAR TOL = 3.0		DRAFT WHERE APPLICABLE MUST REMAIN WITHIN DIMENSIONS		

2.54MM PITCH
DUAL ROW HEADER SINGLE WAFER, T/H

PRODUCT CUSTOMER DRAWING

SERIES	MATERIAL NUMBER	CUSTOMER	
87914	SEE TABLE	GENERAL MARKET	
DOCUMENT NUMBER	DOC TYPE	DOC PART	SHEET NUMBER
SD-87914-013	PSD	000	40 OF 45

RELEASE STATUS	RELEASE DATE
----------------	--------------

PART NO FOR BULK PACKAGING	PART NO. FOR TUBE WITHOUT CAP PACKAGING	PART NO. FOR TUBE WITH CAP PACKAGING	PART NO. FOR TAPE & REEL WITHOUT CAP PACKAGING	PART NO. FOR TAPE & REEL WITH CAP PACKAGING	CKT SIZE	VOID POSITION	PLATING TYPE	DIMENSION				
								A	B	F	M	P
87914-7211	-----	-----	-----	-----	72	-----	1	91.44	88.90	10.92	5.84	2.79
87914-7221	-----	-----	-----	-----	72	-----	1	91.44	88.90	12.25	7.00	2.96
87914-7212	-----	-----	-----	-----	72	-----	2	91.44	88.90	10.92	5.84	2.79
87914-7222	-----	-----	-----	-----	72	-----	2	91.44	88.90	12.25	7.00	2.96
87914-7213	-----	-----	-----	-----	72	-----	3	91.44	88.90	10.92	5.84	2.79
87914-7223	-----	-----	-----	-----	72	-----	3	91.44	88.90	12.25	7.00	2.96
87914-7214	-----	-----	-----	-----	72	-----	4	91.44	88.90	10.92	5.84	2.79
87914-7224	-----	-----	-----	-----	72	-----	4	91.44	88.90	12.25	7.00	2.96
87914-7215	-----	-----	-----	-----	72	-----	5	91.44	88.90	10.92	5.84	2.79
87914-7225	-----	-----	-----	-----	72	-----	5	91.44	88.90	12.25	7.00	2.96
87914-7216	-----	-----	-----	-----	72	-----	6	91.44	88.90	10.92	5.84	2.79
87914-7226	-----	-----	-----	-----	72	-----	6	91.44	88.90	12.25	7.00	2.96

THIS DRAWING CONTAINS INFORMATION THAT IS PROPRIETARY TO MOLEX ELECTRONIC TECHNOLOGIES, LLC AND SHOULD NOT BE USED WITHOUT WRITTEN PERMISSION

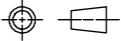
MIGRATED TO NX 2017/01/18 EC NO: 114466 DRWN: PKH CHK'D: REV	2017/03/15 APP: ISHWARG	GENERAL TOLERANCES (UNLESS SPECIFIED)		DIMENSION UNITS		SCALE		
				MM		NTS		
		4 PLACES	±	MM	INCH	DRWN BY	DATE	 <p>2.54MM PITCH DUAL ROW HEADER SINGLE WAFER, T/H</p> <p>PRODUCT CUSTOMER DRAWING</p> <p>SERIES: 87914 MATERIAL NUMBER: SEE TABLE CUSTOMER: GENERAL MARKET</p> <p>DOCUMENT NUMBER: SD-87914-013 DOC TYPE: PSD DOC PART: 000 SHEET NUMBER: 41 OF 45</p>
		3 PLACES	±			KCHO	2004/11/05	
		2 PLACES	± 0.2			CHK'D BY	DATE	
		1 PLACES	±			PTLIM	2004/12/08	
		0 PLACES	±			APPR BY	DATE	
ANGULAR TOL = 3.0				MLONG	2010/09/06			
DRAFT WHERE APPLICABLE MUST REMAIN WITHIN DIMENSIONS				DRAWING SIZE	THIRD ANGLE PROJECTION			
D17				A3				

RELEASE STATUS	RELEASE DATE
----------------	--------------

PART NO FOR BULK PACKAGING	PART NO. FOR TUBE WITHOUT CAP PACKAGING	PART NO. FOR TUBE WITH CAP PACKAGING	PART NO. FOR TAPE & REEL WITHOUT CAP PACKAGING	PART NO. FOR TAPE & REEL WITH CAP PACKAGING	CKT SIZE	VOID POSITION	PLATING TYPE	DIMENSION				
								A	B	F	M	P
87914-7411	-----	-----	-----	-----	74	-----	1	93.98	91.44	10.92	5.84	2.79
87914-7421	-----	-----	-----	-----	74	-----	1	93.98	91.44	12.25	7.00	2.96
87914-7412	-----	-----	-----	-----	74	-----	2	93.98	91.44	10.92	5.84	2.79
87914-7422	-----	-----	-----	-----	74	-----	2	93.98	91.44	12.25	7.00	2.96
87914-7413	-----	-----	-----	-----	74	-----	3	93.98	91.44	10.92	5.84	2.79
87914-7423	-----	-----	-----	-----	74	-----	3	93.98	91.44	12.25	7.00	2.96
87914-7414	-----	-----	-----	-----	74	-----	4	93.98	91.44	10.92	5.84	2.79
87914-7424	-----	-----	-----	-----	74	-----	4	93.98	91.44	12.25	7.00	2.96
87914-7415	-----	-----	-----	-----	74	-----	5	93.98	91.44	10.92	5.84	2.79
87914-7425	-----	-----	-----	-----	74	-----	5	93.98	91.44	12.25	7.00	2.96
87914-7416	-----	-----	-----	-----	74	-----	6	93.98	91.44	10.92	5.84	2.79
87914-7426	-----	-----	-----	-----	74	-----	6	93.98	91.44	12.25	7.00	2.96

THIS DRAWING CONTAINS INFORMATION THAT IS PROPRIETARY TO MOLEX ELECTRONIC TECHNOLOGIES, LLC AND SHOULD NOT BE USED WITHOUT WRITTEN PERMISSION

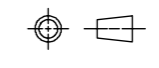
MIGRATED TO NX EC NO: 114466 DRWN: PKH CHK'D: APPR: ISHWARG	2017/01/18		2017/03/15		GENERAL TOLERANCES (UNLESS SPECIFIED)		DIMENSION UNITS		SCALE		 2.54MM PITCH DUAL ROW HEADER SINGLE WAFER, T/H				
							MM INCH		MM NTS						
	4 PLACES		±		±		KCHO		DATE		PRODUCT CUSTOMER DRAWING SERIES: 87914 MATERIAL NUMBER: SEE TABLE CUSTOMER: GENERAL MARKET DOCUMENT NUMBER: SD-87914-013 DOC TYPE: PSD DOC PART: 000 SHEET NUMBER: 42 OF 45				
	3 PLACES		±		±		CHK'D BY		DATE						
	2 PLACES		± 0.2		±		PTLIM		DATE						
	1 PLACES		±		±		APPR BY		DATE						
	0 PLACES		±		±		MLONG		DATE						
							ANGULAR TOL = 3.0		DRAWING SIZE		THIRD ANGLE PROJECTION				
							DRAFT WHERE APPLICABLE MUST REMAIN WITHIN DIMENSIONS		A3						

RELEASE STATUS	RELEASE DATE
----------------	--------------

PART NO FOR BULK PACKAGING	PART NO. FOR TUBE WITHOUT CAP PACKAGING	PART NO. FOR TUBE WITH CAP PACKAGING	PART NO. FOR TAPE & REEL WITHOUT CAP PACKAGING	PART NO. FOR TAPE & REEL WITH CAP PACKAGING	CKT SIZE	VOID POSITION	PLATING TYPE	DIMENSION				
								A	B	F	M	P
87914-7611	-----	-----	-----	-----	76	-----	1	96.52	93.98	10.92	5.84	2.79
87914-7621	-----	-----	-----	-----	76	-----	1	96.52	93.98	12.25	7.00	2.96
87914-7612	-----	-----	-----	-----	76	-----	2	96.52	93.98	10.92	5.84	2.79
87914-7622	-----	-----	-----	-----	76	-----	2	96.52	93.98	12.25	7.00	2.96
87914-7613	-----	-----	-----	-----	76	-----	3	96.52	93.98	10.92	5.84	2.79
87914-7623	-----	-----	-----	-----	76	-----	3	96.52	93.98	12.25	7.00	2.96
87914-7614	-----	-----	-----	-----	76	-----	4	96.52	93.98	10.92	5.84	2.79
87914-7624	-----	-----	-----	-----	76	-----	4	96.52	93.98	12.25	7.00	2.96
87914-7615	-----	-----	-----	-----	76	-----	5	96.52	93.98	10.92	5.84	2.79
87914-7625	-----	-----	-----	-----	76	-----	5	96.52	93.98	12.25	7.00	2.96
87914-7616	-----	-----	-----	-----	76	-----	6	96.52	93.98	10.92	5.84	2.79
87914-7626	-----	-----	-----	-----	76	-----	6	96.52	93.98	12.25	7.00	2.96

THIS DRAWING CONTAINS INFORMATION THAT IS PROPRIETARY TO MOLEX ELECTRONIC TECHNOLOGIES, LLC AND SHOULD NOT BE USED WITHOUT WRITTEN PERMISSION

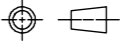
MIGRATED TO NX EC NO: 114466 DRWN: PKH CHK'D: REV APPR: ISHWARG	2017/01/18	GENERAL TOLERANCES (UNLESS SPECIFIED)		DIMENSION UNITS		SCALE		 2.54MM PITCH DUAL ROW HEADER SINGLE WAFER, T/H				
	2017/03/15	MM	INCH	MM	NTS	DRWN BY	DATE					
		4 PLACES ±	±	KCHO	2004/11/05	CHK'D BY	DATE					
		3 PLACES ±	±	PTLIM	2004/12/08	APPR BY	DATE	PRODUCT CUSTOMER DRAWING				
		2 PLACES ± 0.2	±	MLONG	2010/09/06							
		1 PLACES ±	±					SERIES	MATERIAL NUMBER	CUSTOMER		
		0 PLACES ±	±					87914	SEE TABLE	GENERAL MARKET		
				ANGULAR TOL = 3.0	DRAWING SIZE	THIRD ANGLE PROJECTION		DOCUMENT NUMBER		DOC TYPE	DOC PART	SHEET NUMBER
				DRAFT WHERE APPLICABLE MUST REMAIN WITHIN DIMENSIONS	A3			SD-87914-013		PSD	000	43 OF 45

RELEASE STATUS	RELEASE DATE											
----------------	--------------	--	--	--	--	--	--	--	--	--	--	--

PART NO FOR BULK PACKAGING	PART NO. FOR TUBE WITHOUT CAP PACKAGING	PART NO. FOR TUBE WITH CAP PACKAGING	PART NO. FOR TAPE & REEL WITHOUT CAP PACKAGING	PART NO. FOR TAPE & REEL WITH CAP PACKAGING	CKT SIZE	VOID POSITION	PLATING TYPE	DIMENSION				
								A	B	F	M	P
87914-7811	-----	-----	-----	-----	78	-----	1	99.06	96.52	10.92	5.84	2.79
87914-7821	-----	-----	-----	-----	78	-----	1	99.06	96.52	12.25	7.00	2.96
87914-7812	-----	-----	-----	-----	78	-----	2	99.06	96.52	10.92	5.84	2.79
87914-7822	-----	-----	-----	-----	78	-----	2	99.06	96.52	12.25	7.00	2.96
87914-7813	-----	-----	-----	-----	78	-----	3	99.06	96.52	10.92	5.84	2.79
87914-7823	-----	-----	-----	-----	78	-----	3	99.06	96.52	12.25	7.00	2.96
87914-7814	-----	-----	-----	-----	78	-----	4	99.06	96.52	10.92	5.84	2.79
87914-7824	-----	-----	-----	-----	78	-----	4	99.06	96.52	12.25	7.00	2.96
87914-7815	-----	-----	-----	-----	78	-----	5	99.06	96.52	10.92	5.84	2.79
87914-7825	-----	-----	-----	-----	78	-----	5	99.06	96.52	12.25	7.00	2.96
87914-7816	-----	-----	-----	-----	78	-----	6	99.06	96.52	10.92	5.84	2.79
87914-7826	-----	-----	-----	-----	78	-----	6	99.06	96.52	12.25	7.00	2.96

THIS DRAWING CONTAINS INFORMATION THAT IS PROPRIETARY TO MOLEX ELECTRONIC TECHNOLOGIES, LLC AND SHOULD NOT BE USED WITHOUT WRITTEN PERMISSION

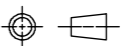
MIGRATED TO NX EC NO: 114466 DRWN: PKH CHK'D: APPR: ISHWARG	2017/01/18	GENERAL TOLERANCES (UNLESS SPECIFIED)		DIMENSION UNITS	SCALE	 2.54MM PITCH DUAL ROW HEADER SINGLE WAFER, T/H PRODUCT CUSTOMER DRAWING
	2017/03/15	MM	INCH	MM	NTS	
	4 PLACES	±	±	DRWN BY	DATE	
	3 PLACES	±	±	KCHO	2004/11/05	
	2 PLACES	± 0.2	±	CHK'D BY	DATE	
1 PLACES	±	±	PTLIM	2004/12/08		
0 PLACES	±	±	APPR BY	DATE		
			MLONG	2010/09/06		
		ANGULAR TOL = 3.0	DRAWING SIZE	THIRD ANGLE PROJECTION		
		DRAFT WHERE APPLICABLE MUST REMAIN WITHIN DIMENSIONS	A3			

SERIES	MATERIAL NUMBER	CUSTOMER	
87914	SEE TABLE	GENERAL MARKET	
DOCUMENT NUMBER	DOC TYPE	DOC PART	SHEET NUMBER
SD-87914-013	PSD	000	44 OF 45

RELEASE STATUS	RELEASE DATE

PART NO FOR BULK PACKAGING	PART NO. FOR TUBE WITHOUT CAP PACKAGING	PART NO. FOR TUBE WITH CAP PACKAGING	PART NO. FOR TAPE & REEL WITHOUT CAP PACKAGING	PART NO. FOR TAPE & REEL WITH CAP PACKAGING	CKT SIZE	VOID POSITION	PLATING TYPE	DIMENSION				
								A	B	F	M	P
87914-8011	-----	-----	-----	-----	80	-----	1	101.60	99.06	10.92	5.84	2.79
87914-8021	-----	-----	-----	-----	80	-----	1	101.60	99.06	12.25	7.00	2.96
87914-8012	-----	-----	-----	-----	80	-----	2	101.60	99.06	10.92	5.84	2.79
87914-8022	-----	-----	-----	-----	80	-----	2	101.60	99.06	12.25	7.00	2.96
87914-8013	-----	-----	-----	-----	80	-----	3	101.60	99.06	10.92	5.84	2.79
87914-8023	-----	-----	-----	-----	80	-----	3	101.60	99.06	12.25	7.00	2.96
87914-8014	-----	-----	-----	-----	80	-----	4	101.60	99.06	10.92	5.84	2.79
87914-8024	-----	-----	-----	-----	80	-----	4	101.60	99.06	12.25	7.00	2.96
87914-8015	-----	-----	-----	-----	80	-----	5	101.60	99.06	10.92	5.84	2.79
87914-8025	-----	-----	-----	-----	80	-----	5	101.60	99.06	12.25	7.00	2.96
87914-8016	-----	-----	-----	-----	80	-----	6	101.60	99.06	10.92	5.84	2.79
87914-8026	-----	-----	-----	-----	80	-----	6	101.60	99.06	12.25	7.00	2.96

THIS DRAWING CONTAINS INFORMATION THAT IS PROPRIETARY TO MOLEX ELECTRONIC TECHNOLOGIES, LLC AND SHOULD NOT BE USED WITHOUT WRITTEN PERMISSION

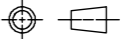
MIGRATED TO NX EC NO: 114466 DRWN: PKH CHK'D: REV APPR: ISHWARG	2017/01/18		2017/03/15		GENERAL TOLERANCES (UNLESS SPECIFIED)		DIMENSION UNITS		SCALE					
					MM INCH		MM NTS		NTS					
	4 PLACES		±		±		DRWN BY		DATE		2.54MM PITCH DUAL ROW HEADER SINGLE WAFER, T/H			
	3 PLACES		±		±		KCHO		2004/11/05					
	2 PLACES		± 0.2		±		CHK'D BY		DATE					
	1 PLACES		±		±		PTLIM		2004/12/08		PRODUCT CUSTOMER DRAWING			
0 PLACES		±		±		APPR BY		DATE						
						MLONG		2010/09/06		SERIES MATERIAL NUMBER CUSTOMER 87914 SEE TABLE GENERAL MARKET				
						ANGULAR TOL = 3.0		DRAWING SIZE		THIRD ANGLE PROJECTION		DOCUMENT NUMBER DOC TYPE DOC PART SHEET NUMBER SD-87914-013 PSD 000 45 OF 45		
						DRAFT WHERE APPLICABLE MUST REMAIN WITHIN DIMENSIONS		A3						

RELEASE STATUS	RELEASE DATE
----------------	--------------