

Monolithic 1A Step-Down Regulator with Low Quiescent Current

The EL7531 is a synchronous, integrated FET 1A step-down regulator with internal compensation. It operates with an input voltage range from 2.5V to 5.5V, which accommodates supplies of 3.3V, 5V, or a Li-Ion battery source. The output can be externally set from 0.8V to V_{IN} with a resistive divider.

The EL7531 features automatic PFM/PWM mode control, or PWM mode only. The PWM frequency is typically 1.4MHz and can be synchronized up to 12MHz. The typical no load quiescent current is only 120µA. Additional features include a Power-Good output, <1µA shut-down current, short-circuit protection, and over-temperature protection.

The EL7531 is available in the 10 Ld MSOP package, making the entire converter occupy less than 0.15 in² of PCB area with components on one side only. The 10 Ld MSOP package is specified for operation over the full -40°C to +85°C temperature range.

Ordering Information

| PART NUMBER | PART MARKING | TAPE & REEL | PACKAGE | PKG. DWG. # |
|----------------------|--------------|-------------|----------------------|-------------|
| EL7531IYZ (Note) | BHAAA | - | 10 Ld MSOP (Pb-free) | M10.118A |
| EL7531IYZ-T7 (Note) | BHAAA | 7" | 10 Ld MSOP (Pb-free) | M10.118A |
| EL7531IYZ-T13 (Note) | BHAAA | 13" | 10 Ld MSOP (Pb-free) | M10.118A |

NOTE: Intersil Pb-free plus anneal products employ special Pb-free material sets; molding compounds/die attach materials and 100% matte tin plate termination finish, which are RoHS compliant and compatible with both SnPb and Pb-free soldering operations. Intersil Pb-free products are MSL classified at Pb-free peak reflow temperatures that meet or exceed the Pb-free requirements of IPC/JEDEC J STD-020.

Pinout

EL7531 (10 LD MSOP) TOP VIEW

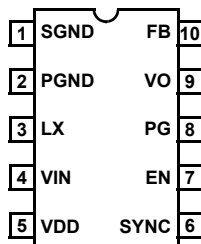

Features

- Less than 0.15 in² (0.97 cm²) footprint for the complete 1A converter
- Components on one side of PCB
- Max height 1.1mm MSOP10
- Power-Good (PG) output
- Internally-compensated voltage mode controller
- Up to 94% efficiency
- <1µA shut-down current
- 120µA quiescent current
- Overcurrent and over-temperature protection
- External synchronizable up to 12MHz
- Pb-Free plus anneal available (RoHS compliant)

Applications

- PDA and pocket PC computers
- Bar code readers
- Cellular phones
- Portable test equipment
- Li-Ion battery powered devices
- Small form factor (SFP) modules

Typical Application Diagram

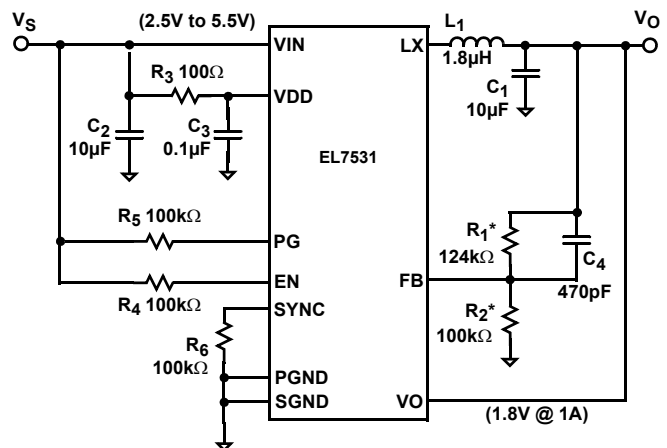

$$* V_O = 0.8V * (1 + R_1 / R_2)$$

Absolute Maximum Ratings ($T_A = 25^\circ\text{C}$)

| | | | |
|---|-------------------------------------|---|-----------------|
| $V_{IN}, V_{DD}, \text{PG to SGND}$ | -0.3V to +6.5V | Peak Output Current | 1.2A |
| LX to PGND | -0.3V to ($V_{IN} + 0.3\text{V}$) | Operating Ambient Temperature | -40°C to +85°C |
| SYNC, EN, V_O , FB to SGND | -0.3V to ($V_{IN} + 0.3\text{V}$) | Storage Temperature | -65°C to +150°C |
| PGND to SGND | -0.3V to +0.3V | Junction Temperature | +125°C |

CAUTION: Stresses above those listed in "Absolute Maximum Ratings" may cause permanent damage to the device. This is a stress only rating and operation of the device at these or any other conditions above those indicated in the operational sections of this specification is not implied.

IMPORTANT NOTE: All parameters having Min/Max specifications are guaranteed. Typ values are for information purposes only. Unless otherwise noted, all tests are at the specified temperature and are pulsed tests, therefore: $T_J = T_C = T_A$

Electrical Specifications $V_{DD} = V_{IN} = V_{EN} = 3.3\text{V}$, $C_1 = C_2 = 10\mu\text{F}$, $L = 1.8\mu\text{H}$, $V_O = 1.8\text{V}$ (as shown in Typical Application Diagram), unless otherwise specified.

| PARAMETER | DESCRIPTION | CONDITIONS | MIN | TYP | MAX | UNIT |
|---------------------------|--|--|------|-----|-----|------------------|
| DC CHARACTERISTICS | | | | | | |
| V_{FB} | Feedback Input Voltage | PWM mode | 790 | 800 | 810 | mV |
| $\Delta V_{OUT}/V_{OUT}$ | V_{FB} vs Temperature | Junction temperature = -40°C to +85°C (see Figure 7) | | 0.3 | | % |
| $\Delta V_{OUT}/V_{OUT}$ | Line Regulation | $V_{IN} = 3.3\text{V}$ to 5V, $I_O = 1\text{A}$ (see Figure 7) | | 0.1 | | % |
| $\Delta V_{OUT}/V_{OUT}$ | Load Regulation | $I_O = 0\text{A}$ to 1A, $V_{IN} = 3.3\text{V}$ (see Figure 7) | | 0.4 | | % |
| I_{FB} | Feedback Input Current | | | | 100 | nA |
| V_{IN}, V_{DD} | Input Voltage | | 2.5 | | 5.5 | V |
| $V_{IN,OFF}$ | Minimum Voltage for Shutdown | V_{IN} falling | 2 | | 2.2 | V |
| $V_{IN,ON}$ | Maximum Voltage for Startup | V_{IN} rising | 2.2 | | 2.4 | V |
| I_S | Input Supply Quiescent Current | | | | | |
| | Active - PFM Mode | $V_{SYNC} = 0\text{V}$ | | 120 | 145 | μA |
| | Active - PWM Mode | $V_{SYNC} = 3.3\text{V}$ | | 6.5 | 7.5 | mA |
| I_{DD} | Supply Current | PWM, $V_{IN} = V_{DD} = 5\text{V}$ | | 400 | 500 | μA |
| | | EN = 0, $V_{IN} = V_{DD} = 5\text{V}$ | | 0.1 | 1 | μA |
| $R_{DS(ON)-PMOS}$ | PMOS FET Resistance | $V_{DD} = 5\text{V}$, wafer test only | | 70 | 100 | $\text{m}\Omega$ |
| $R_{DS(ON)-NMOS}$ | NMOS FET Resistance | $V_{DD} = 5\text{V}$, wafer test only | | 45 | 75 | $\text{m}\Omega$ |
| I_{LMAX} | Current Limit | | | 1.5 | | A |
| $T_{OT,OFF}$ | Over-temperature Threshold | T rising | | 145 | | °C |
| $T_{OT,ON}$ | Over-temperature Hysteresis | T falling | | 130 | | °C |
| I_{EN}, I_{SYNC} | EN, SYNC Current | $V_{EN}, V_{RSI} = 0\text{V}$ and 3.3V | -1 | | 1 | μA |
| V_{EN1}, V_{SYNC1} | EN, SYNC Rising Threshold | $V_{DD} = 3.3\text{V}$ | 2.4 | 1.8 | | V |
| V_{EN2}, V_{SYNC2} | EN, SYNC Falling Threshold | $V_{DD} = 3.3\text{V}$ | 9 | 1.4 | 0.8 | V |
| V_{PG} | Minimum V_{FB} for PG, WRT Targeted V_{FB} Value | V_{FB} rising | | | 95 | % |
| | | V_{FB} falling | 86 | | | % |
| V_{OLPG} | PG Voltage Drop | $I_{SINK} = 3.3\text{mA}$ | | 35 | 70 | mV |
| AC CHARACTERISTICS | | | | | | |
| F_{PWM} | PWM Switching Frequency | | 1.25 | 1.4 | 1.6 | MHz |
| t_{SYNC} | Minimum SYNC Pulse Width | Guaranteed by design | 25 | | | ns |
| t_{SS} | Soft-start Time | | | 650 | | μs |

Pin Descriptions

| PIN NUMBER | PIN NAME | PIN FUNCTION |
|------------|----------|--|
| 1 | SGND | Negative supply for the controller stage |
| 2 | PGND | Negative supply for the power stage |
| 3 | LX | Inductor drive pin; high current digital output with average voltage equal to the regulator output voltage |
| 4 | VIN | Positive supply for the power stage |
| 5 | VDD | Power supply for the controller stage |
| 6 | SYNC | SYNC input pin; when connected to HI, regulator runs at forced PWM mode; when connected to Low, auto PFM/PWM mode; when connected to external sync signal, at external PWM frequency up to 12MHz |
| 7 | EN | Enable |
| 8 | PG | Power-Good open drain output |
| 9 | VO | Output voltage sense |
| 10 | FB | Voltage feedback input; connected to an external resistor divider between V_O and SGND for variable output |

Block Diagram

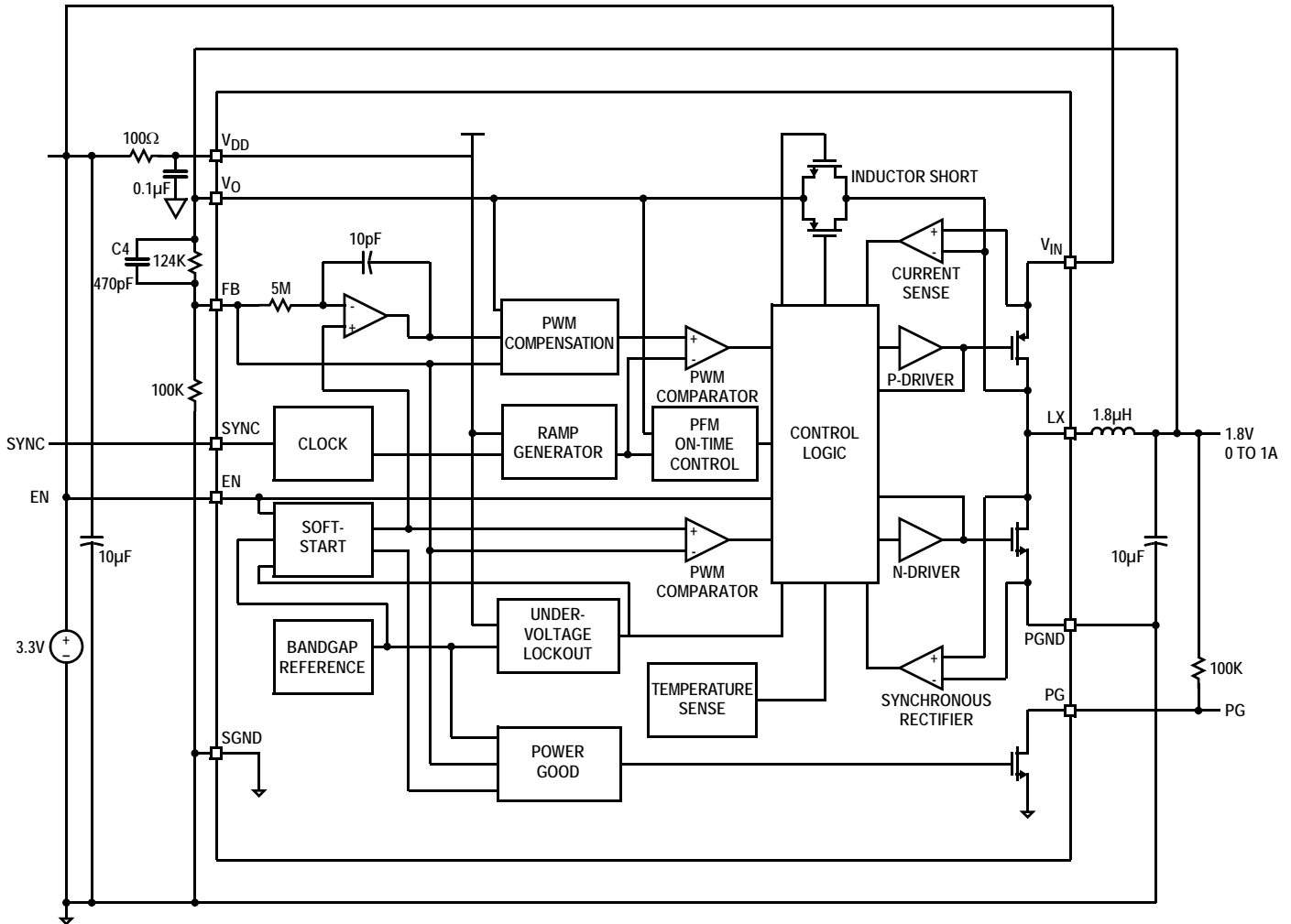

Performance Curves and Waveforms

All waveforms are taken at $V_{IN} = 3.3V$, $V_O = 1.8V$, $I_O = 1A$ with component values shown on page 1 at room ambient temperature, unless otherwise noted.

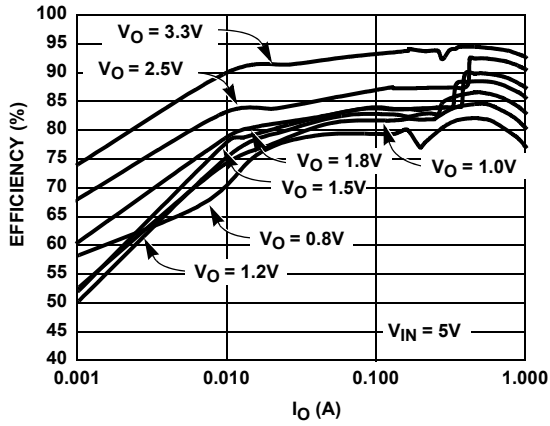

FIGURE 1. EFFICIENCY vs I_O (PFM/PWM MODE)

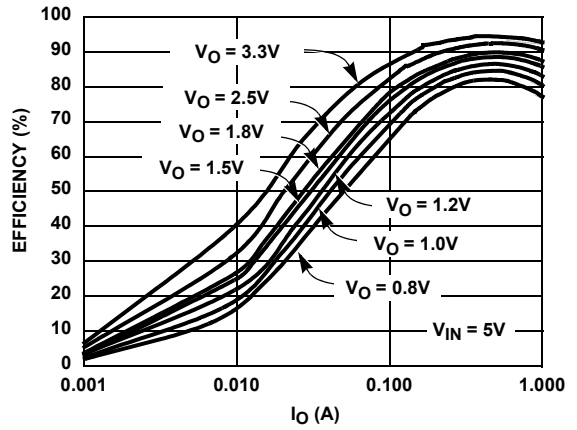

FIGURE 2. EFFICIENCY vs I_O (PWM MODE)

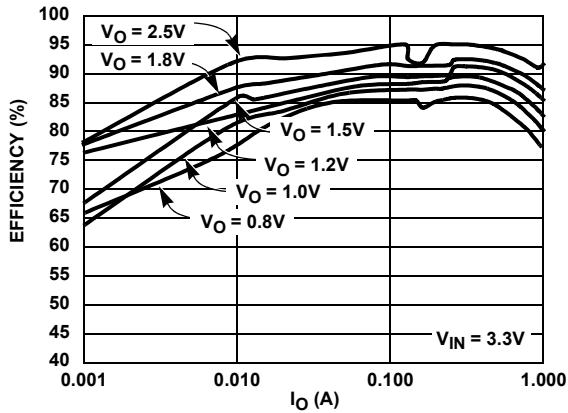

FIGURE 3. EFFICIENCY vs I_O (PFM/PWM MODE)

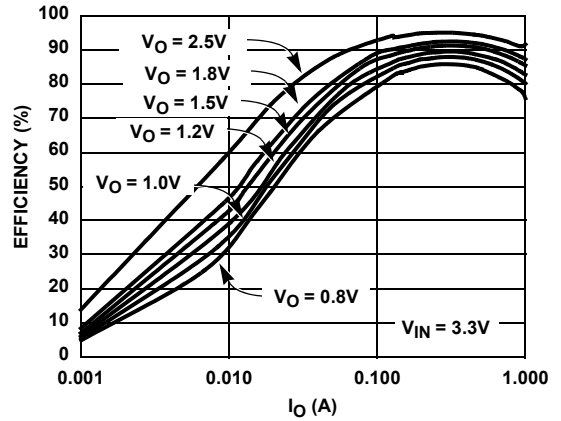

FIGURE 4. EFFICIENCY vs I_O (PWM MODE)

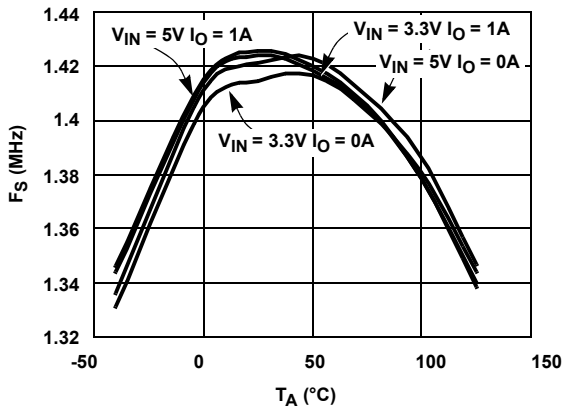

FIGURE 5. F_S vs JUNCTION TEMPERATURE (PWM MODE)

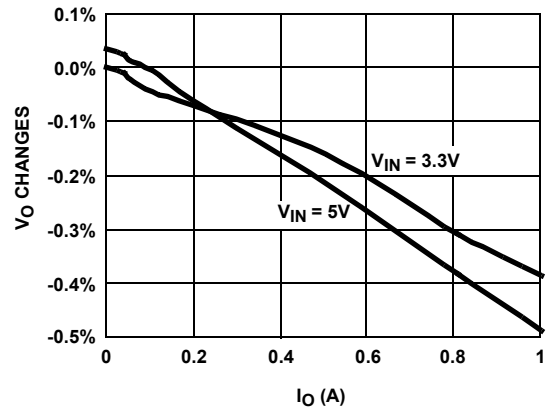

FIGURE 6. LOAD REGULATIONS (PWM MODE)

Performance Curves and Waveforms (Continued)

All waveforms are taken at $V_{IN} = 3.3V$, $V_O = 1.8V$, $I_O = 1A$ with component values shown on page 1 at room ambient temperature, unless otherwise noted.

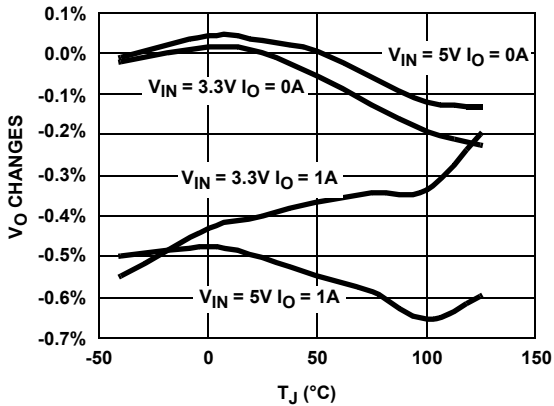

FIGURE 7. PWM MODE LOAD/LINE REGULATIONS vs JUNCTION TEMPERATURE

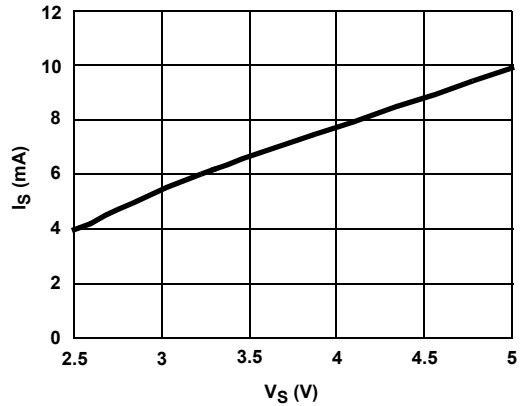

FIGURE 8. NO LOAD QUIESCENT CURRENT (PWM MODE)

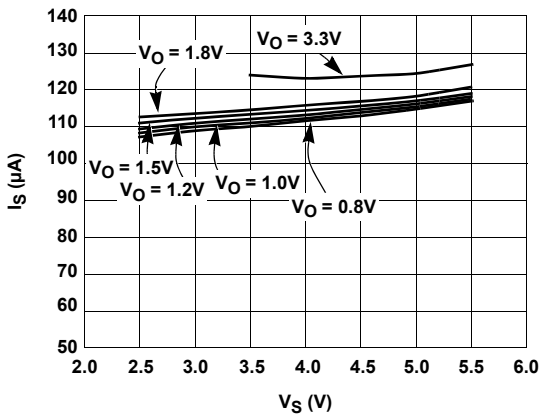

FIGURE 9. NO LOAD QUIESCENT CURRENT (PFM MODE)

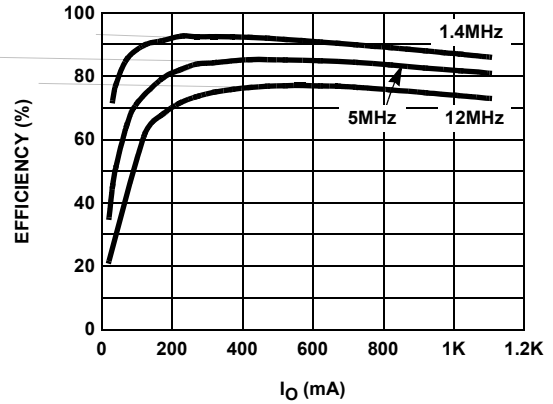

FIGURE 10. EFFICIENCY vs I_O (PWM MODE)

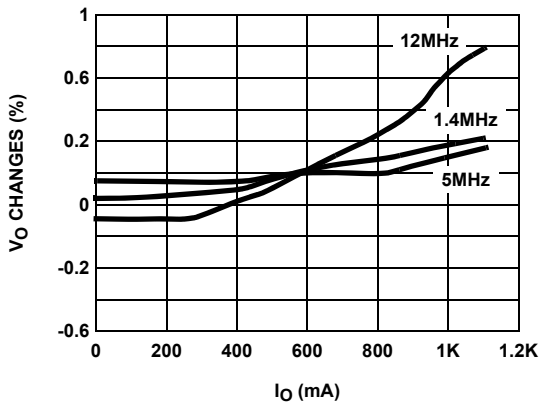

FIGURE 11. LOAD REGULATION (PWM MODE)

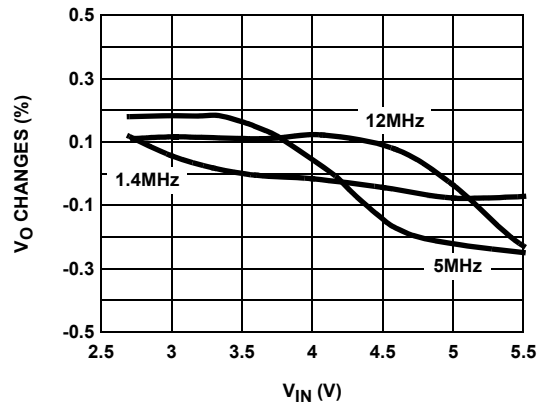

FIGURE 12. LINE REGULATION @ 500mA (PWM MODE)

Performance Curves and Waveforms (Continued)

All waveforms are taken at $V_{IN} = 3.3V$, $V_O = 1.8V$, $I_O = 1A$ with component values shown on page 1 at room ambient temperature, unless otherwise noted.

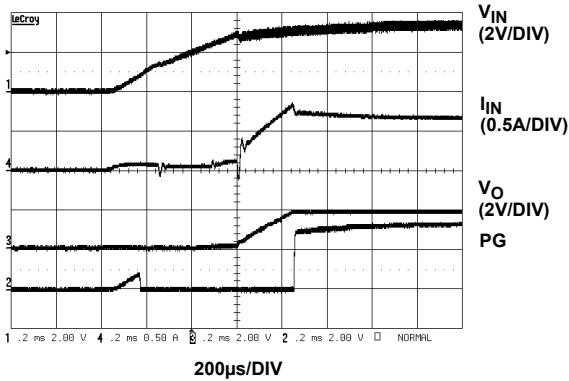

FIGURE 13. START-UP AT $I_O = 1A$

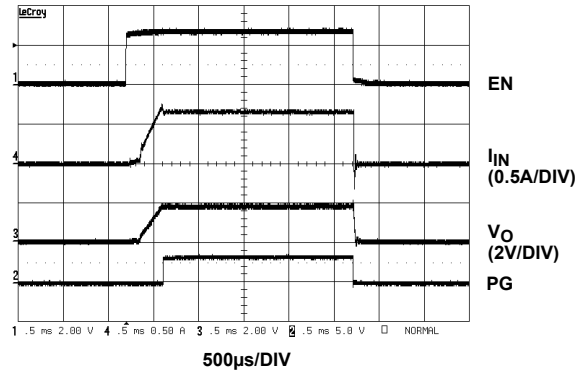

FIGURE 14. ENABLE AND SHUT-DOWN

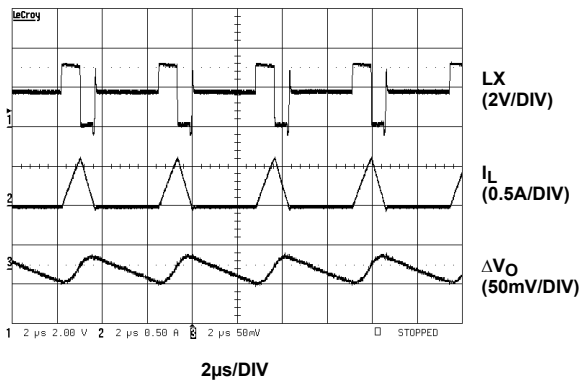

FIGURE 15. PFM STEADY-STATE OPERATION WAVEFORM ($I_O = 100mA$)

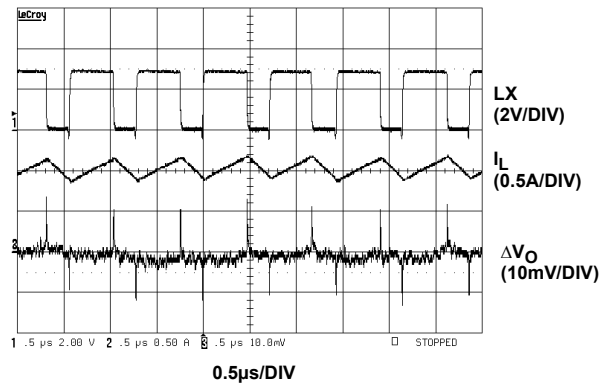

FIGURE 16. PWM STEADY-STATE OPERATION ($I_O = 1A$)

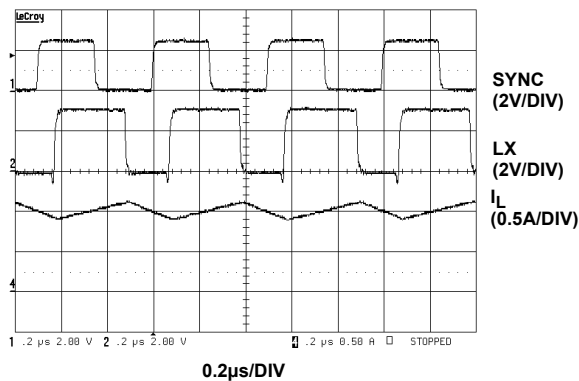

FIGURE 17. EXTERNAL SYNCHRONIZATION TO 2MHz

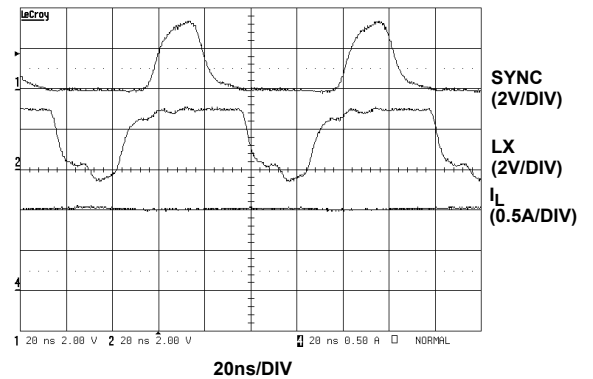

FIGURE 18. EXTERNAL SYNCHRONIZATION TO 12MHz

Performance Curves and Waveforms (Continued)

All waveforms are taken at $V_{IN} = 3.3V$, $V_O = 1.8V$, $I_O = 1A$ with component values shown on page 1 at room ambient temperature, unless otherwise noted.

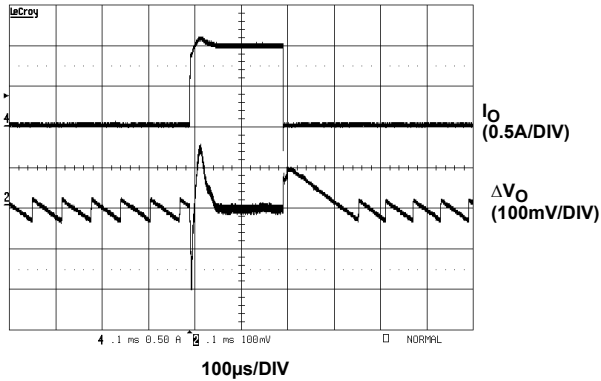

FIGURE 19. LOAD TRANSIENT RESPONSE (22mA to 1A)

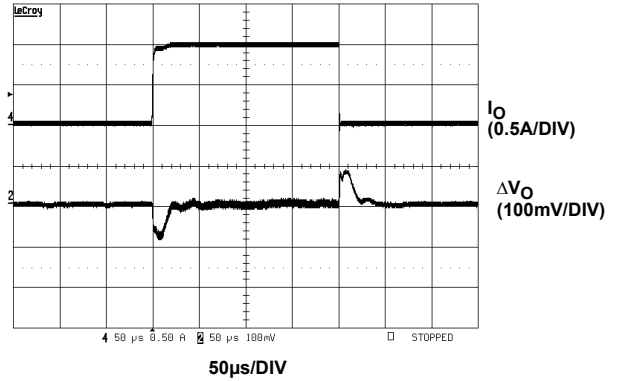

FIGURE 20. PWM LOAD TRANSIENT RESPONSE (0A TO 1A)

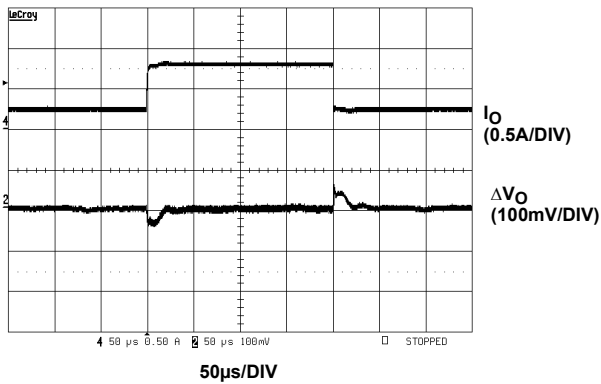

FIGURE 21. PWM LOAD TRANSIENT RESPONSE (0.25A TO 0.75A)

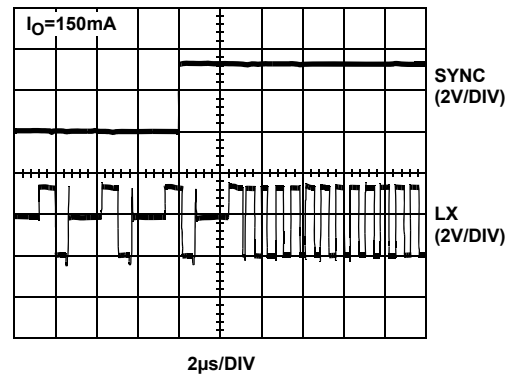

FIGURE 22. PFM-PWM TRANSITION TIME

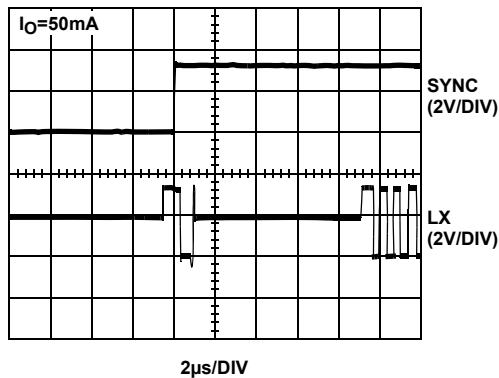

FIGURE 23. PFM-PWM TRANSITION TIME

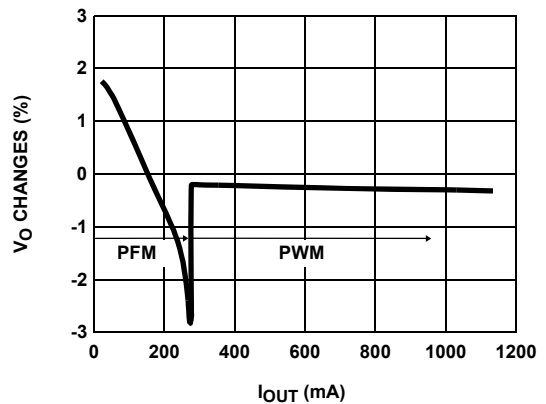

FIGURE 24. PFM-PWM LOAD REGULATION

Performance Curves and Waveforms (Continued)

All waveforms are taken at $V_{IN} = 3.3V$, $V_O = 1.8V$, $I_O = 1A$ with component values shown on page 1 at room ambient temperature, unless otherwise noted.

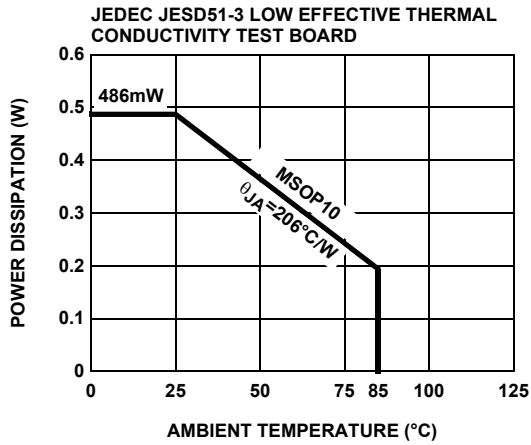

FIGURE 25. PACKAGE POWER DISSIPATION vs AMBIENT TEMPERATURE

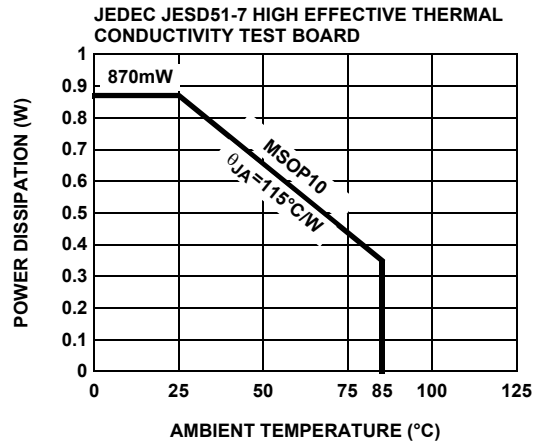

FIGURE 26. PACKAGE POWER DISSIPATION vs AMBIENT TEMPERATURE

Applications Information

Product Description

The EL7531 is a synchronous, integrated FET 1A step-down regulator which operates from an input of 2.5V to 5.5V. The output voltage is user-adjustable with a pair of external resistors.

When the load is very light, the regulator automatically operates in the PFM mode, thus achieving high efficiency at light load (>70% for 1mA load). When the load increases to typically 250mA, the regulator automatically switches over to a voltage-mode PWM operating at nominal 1.4MHz switching frequency. The efficiency is up to 94%.

It can also operate in a fixed PWM mode or be synchronized to an external clock up to 12MHz for improved EMI performance.

PFM Operation

The heart of the EL7531 regulator is the automatic PFM/PWM controller.

If the SYNC pin is connected to ground, the regulator operates automatically in either the PFM or PWM mode, depending on load. When the SYNC pin is connected to V_{IN} , the regulator operates in the fixed PWM mode. When the pin is connected to an external clock ranging from 1.6MHz to 12MHz, the regulator is in the fixed PWM mode and synchronized to the external clock frequency.

In the automatic PFM/PWM operation, when the load is light, the regulator operates in the PFM mode to achieve high efficiency. The top P channel MOSFET is turned on first. The inductor current increases linearly to a preset value before it is turned off. Then the bottom N channel MOSFET turns on, and the inductor current linearly decreases to zero current. The N channel MOSFET is then turned off, and an anti-ringing MOSFET is turned on to clamp the V_{LX} pin to V_O . The inductor current looks like triangular pulses. The frequency of the pulses is mainly a function of output current. The higher the load, the higher the frequency of the pulses until the inductor current becomes continuous. At this point, the controller automatically changes to PWM operation.

When the controller transitions to PWM mode, there can be a perturbation to the output voltage. This perturbation is due to the inherent behavior of switching converters when transitioning between two control loops. To reduce this effect, it is recommended to use the phase-lead capacitor (C_4) shown in the Typical Application Diagram on page 1. This capacitor allows the PWM loop to respond more quickly to this type of perturbation. To properly size C_4 , refer to the Component Selection section.

PWM Operation

The regulator operates the same way in the forced PWM or synchronized PWM mode. In this mode, the inductor current is always continuous and does not stay at zero.

In this mode, the P channel MOSFET and N channel MOSFET always operate complementary. When the PMOSFET is on and the NMOSFET off, the inductor current increases linearly. The input energy is transferred to the output and also stored in the inductor. When the P channel MOSFET is off and the N channel MOSFET on, the inductor current decreases linearly, and energy is transferred from the inductor to the output. Hence, the average current through the inductor is the output current. Since the inductor and the output capacitor act as a low pass filter, the duty cycle ratio is approximately equal to V_O divided by V_{IN} .

The output LC filter has a second order effect. To maintain the stability of the converter, the overall controller must be compensated. This is done with the fixed internally compensated error amplifier and the PWM compensator. Because the compensations are fixed, the values of input and output capacitors are 10 μ F to 22 μ F ceramic and inductor is 1.5 μ H to 2.2 μ H.

Forced PWM Mode/SYNC Input

Pulling the SYNC pin HI (>2.5V) forces the converter into PWM mode in the next switching cycle regardless of output current. The duration of the transition varies depending on the output current. Figures 22 and 23 (under two different loading conditions) show the device goes from PFM to PWM mode.

Note: In forced PWM mode, the IC will continue to start-up in PFM mode to support pre-biased load applications.

Start-Up and Shut-Down

When the EN pin is tied to V_{IN} , and V_{IN} reaches approximately 2.4V, the regulator begins to switch. The inductor current limit is gradually increased to ensure proper soft-start operation.

When the EN pin is connected to a logic low, the EL7531 is in the shut-down mode. All the control circuitry and both MOSFETs are off, and V_{OUT} falls to zero. In this mode, the total input current is less than 1 μ A.

When the EN reaches logic HI, the regulator repeats the start-up procedure, including the soft-start function.

Current Limit and Short-Circuit Protection

The current limit is set at about 2A for the PMOS. When a short-circuit occurs in the load, the preset current limit restricts the amount of current available to the output, which causes the output voltage to drop below the preset voltage. In the meantime, the excessive current heats up the regulator until it reaches the thermal shut-down point.

Thermal Shut-Down

Once the junction reaches about 145°C, the regulator shuts down. Both the P channel and the N channel MOSFETs turn off. The output voltage will drop to zero. With the output MOSFETs turned off, the regulator will soon cool down. Once the junction temperature drops to about 130°C, the regulator will restart again in the same manner as EN pin connects to logic HI.

Thermal Performance

The EL7531 is available in a fused-lead MSOP10 package. Compared with regular MSOP10 package, the fused-lead package provides lower thermal resistance. The θ_{JA} is 100°C/W on a 4-layer board and 125°C/W on 2-layer board. Maximizing the copper area around the pins will further improve the thermal performance.

Power Good Output

The PG (pin 8) output is used to indicate when the output voltage is properly regulating at the desired set point. It is an open-drain output that should be tied to VIN or VCC through a 100kΩ resistor. If no faults are detected, EN is high, and the output voltage is within ~5% of regulation, the PG pin will be allowed to go high. Otherwise, the open-drain NMOS will pull PG low.

Output Voltage Selection

Users can set the output voltage of the variable version with a resistor divider, which can be chosen based on the following formula:

$$V_O = 0.8 \times \left(1 + \frac{R_2}{R_1} \right)$$

Component Selection

Because of the fixed internal compensation, the component choice is relatively narrow. For a regulator with fixed output voltage, only two capacitors and one inductor are required. We recommend 10μF to 22μF multi-layer ceramic capacitors with X5R or X7R rating for both the input and output capacitors, and 1.5 to 2.2μH for the inductor.

The RMS current present at the input capacitor is decided by the following formula:

$$I_{INRMS} = \frac{\sqrt{V_O \times (V_{IN} - V_O)}}{V_{IN}} \times I_O$$

This is about half of the output current I_O for all the V_O . This input capacitor must be able to handle this current.

The inductor peak-to-peak ripple current is given as:

$$\Delta I_{IL} = \frac{(V_{IN} - V_O) \times V_O}{L \times V_{IN} \times f_S}$$

L is the inductance

f_S the switching frequency (nominally 1.4MHz)

The inductor must be able to handle I_O for the RMS load current, and to assure that the inductor is reliable, it must handle the 2A surge current that can occur during a current limit condition.

In addition to decoupling capacitors and inductor value, it is important to properly size the phase-lead capacitor C_4 (Refer to the Typical Application Diagram). The phase-lead capacitor creates additional phase margin in the control loop by generating a zero and a pole in the transfer function. As a general rule of thumb, C_4 should be sized to start the phase-lead at a frequency of ~2.5kHz. The zero will always appear at lower frequency than the pole and follow the equation below:

$$f_Z = \frac{1}{2\pi R_2 C_4}$$

Over a normal range of R_2 (~10-100k), C_4 will range from ~470-4700pF. The pole frequency cannot be set once the zero frequency is chosen as it is dictated by the ratio of R_1 and R_2 , which is solely determined by the desired output set point. The equation below shows the pole frequency relationship:

$$f_P = \frac{1}{2\pi(R_1 || R_2)C_4}$$

Layout Considerations

The layout is very important for the converter to function properly. The following PC layout guidelines should be followed:

1. Separate the Power Ground (↓) and Signal Ground ($\frac{\perp}{\perp}$); connect them only at one point right at the pins
2. Place the input capacitor as close to V_{IN} and PGND pins as possible
3. Make the following PC traces as small as possible:
 4. from LX pin to L
 5. from C_O to PGND
 6. If used, connect the trace from the FB pin to R_1 and R_2 as close as possible
 7. Maximize the copper area around the PGND pin
 8. Place several via holes under the chip to additional ground plane to improve heat dissipation

The demo board is a good example of layout based on this outline. Please refer to the EL7531 Application Brief.

Revision History

The revision history provided is for informational purposes only and is believed to be accurate, but not warranted. Please go to the web to make sure that you have the latest revision.

| DATE | REVISION | CHANGE |
|-------------------|-----------|--|
| December 10, 2015 | FN7428.10 | - Updated Ordering Information Table on page 1. - Added Revision History. - Added About Intersil Verbiage. - Replaced POD from MDP0043 to M10.118A. |

About Intersil

Intersil Corporation is a leading provider of innovative power management and precision analog solutions. The company's products address some of the largest markets within the industrial and infrastructure, mobile computing and high-end consumer markets.

For the most updated datasheet, application notes, related documentation and related parts, please see the respective product information page found at www.intersil.com.

You may report errors or suggestions for improving this datasheet by visiting www.intersil.com/ask.

Reliability reports are also available from our website at www.intersil.com/support.

All Intersil U.S. products are manufactured, assembled and tested utilizing ISO9001 quality systems. Intersil Corporation's quality certifications can be viewed at www.intersil.com/design/quality

Intersil products are sold by description only. Intersil Corporation reserves the right to make changes in circuit design, software and/or specifications at any time without notice. Accordingly, the reader is cautioned to verify that data sheets are current before placing orders. Information furnished by Intersil is believed to be accurate and reliable. However, no responsibility is assumed by Intersil or its subsidiaries for its use; nor for any infringements of patents or other rights of third parties which may result from its use. No license is granted by implication or otherwise under any patent or patent rights of Intersil or its subsidiaries.

For information regarding Intersil Corporation and its products, see www.intersil.com

Package Outline Drawing

M10.118A (JEDEC MO-187-BA)
 10 LEAD MINI SMALL OUTLINE PLASTIC PACKAGE (MSOP)
 Rev 0, 9/09

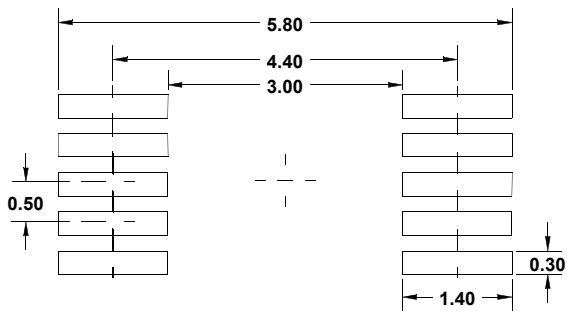
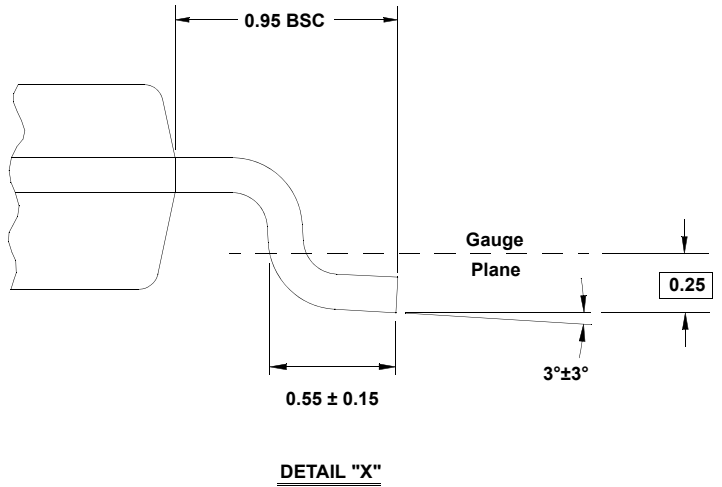
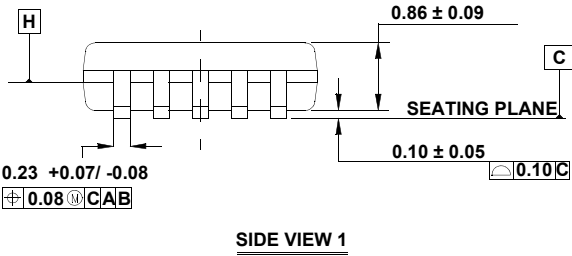
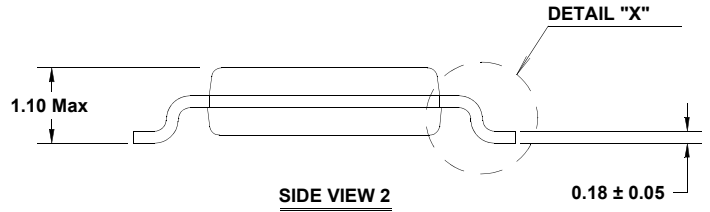
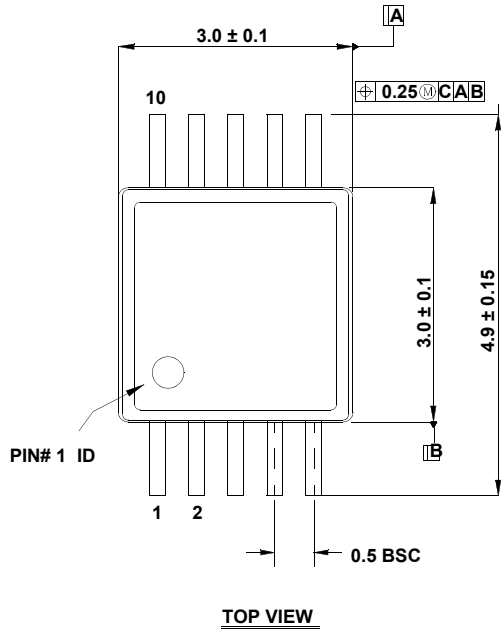

NOTES:

1. Dimensions are in millimeters.
2. Dimensioning and tolerancing conform to AMSE Y14.5m-1994.
3. Plastic or metal protrusions of 0.15mm max per side are not included.
4. Plastic interlead protrusions of 0.25mm max per side are not included.
5. Dimensions "D" and "E1" are measured at Datum Plane "H".
6. This replaces existing drawing # MDP0043 MSOP10L.