

Type SMP Connectors

Product Catalog

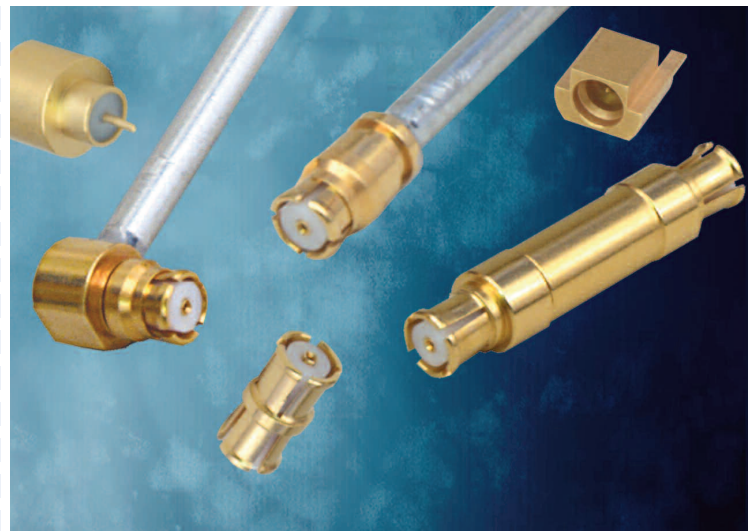

Table of Contents

	PAGE
Introduction	3-4
Specifications	5-8
Mounting Holes	7
Applications	9-12
Assembly Tools	13
Assembly Instructions	14-18
Competitor Cross Reference	19

SMP Blind-Mate Connectors

Emerson's new **Johnson®** line of **SMP Blind-Mate Connectors** offers our customers a Micro-Miniature, Slide-On/Snap-On Interconnect System that aids in the design of high-density packaging as well as axial and radial misalignment issues.

The **SMP** Interface offers superior performance up to 40 GHz and is compatible with all SMP and **GPO®** Connectors. They offer high electrical reliability where extreme shock and vibration conditions are experienced.

Applications (Military and Commercial)

- Phased Arrays
- Active Antennas
- Satellites
- Communication Equipment
- Airborne Radar
- Shipborne Radar
- Ground Radar
- Hi-Density Modular Packaging
- Axial/ Radial Misalignment Solutions

Markets

- Aerospace
- Broadband
- Instrumentation
- Telecom
- Defense
- Microwave

Transmission Options

- Box-to-Box
- Cable-to-Board
- Board-to-Board
- Cable-to-Panel-to-Board

*GPO® is a registered trademark of Corning Gilbert.

Description

One of the key benefits of the SMP connector interface is its use in high frequency blind-mate applications. The design of the SMP bullet and shroud system allows for both axial and radial misalignment. The basic system is comprised of an inner “bullet” adapter, and two outer receptacles called “shrouds”. The bullet provides a flexible link between the shroud connections.

In blind-mate applications, one shroud connector will be typically specified as a snap-on interface and the other as a slide-on. This ensures that the bullet adapter remains fixed in the same shroud connector when the connection is disengaged.

The two snap-on interfaces Full Detent (FD) and Limited Detent (LD) each have different engage and disengage coupling forces. The LD is typically selected as the snap-on interface in PCB mount or blind-mate applications, while the FD is mainly used for cabled connections where higher retention forces are required.

The two slide-on interfaces Smooth Bore (SM) and Catcher’s Mit (CM) allow for reduced connection forces as compared to the snap-on versions. The push-on interface creates a sliding connection that does not physically locate the mating reference planes, allowing for axial and radial misalignment. Both the SM and CM have the same engage/disengage forces; however the CM is typically specified as the shroud configuration in blind-mate applications as its generous lead-in chamfer helps capture and guide the bullet into place.

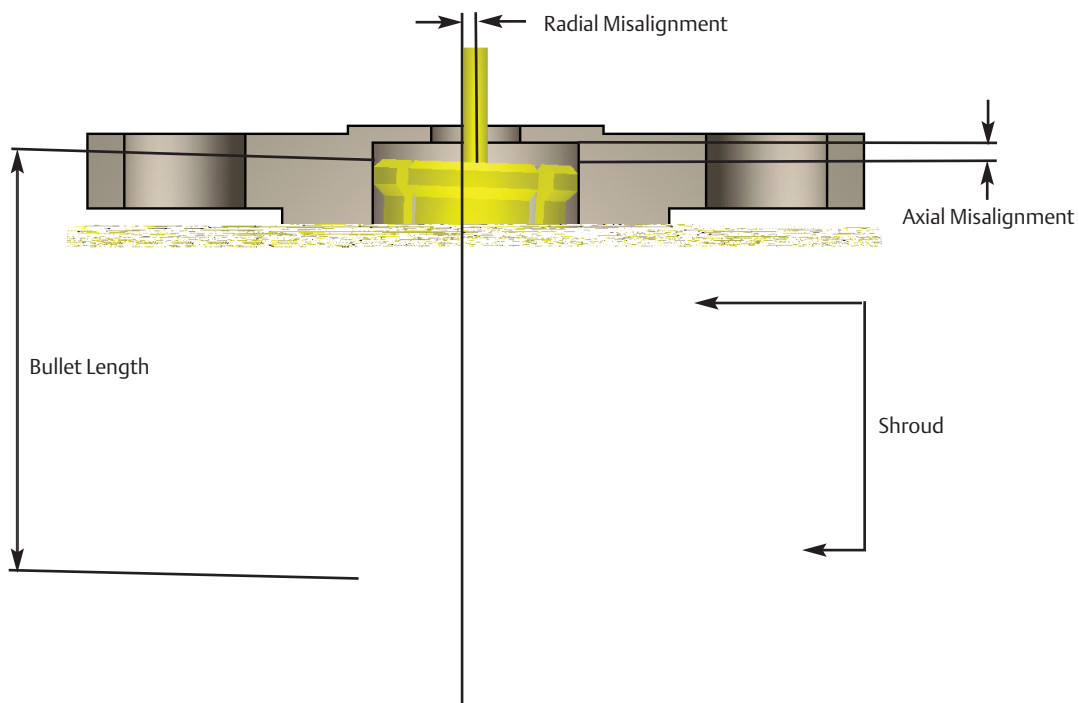

ELECTRICAL SPECIFICATIONS

Impedance: 50 Ohms

Frequency Range:

Bullet Adapter (.254 length), Semi-Rigid Straight Cabled Connectors	0-40 GHz
All other In-Series Adapters, Semi-Rigid Right Angle Cabled Connectors, Field Replaceable Connectors, End Launch Connectors, Hermetic Feedthroughs	0-18 GHz
PC Mount Connectors	0-12 GHz

VSWR: (maximum)

	<u>0-18 GHz</u>	<u>18-23 GHz</u>	<u>23-26.5 GHz</u>	<u>26.5-40 GHz</u>
Bullet Adapter (.254 length)	1.10	1.15	1.30	1.70
Semi-Rigid Straight Cabled Connectors		<u>0-18 GHz</u> .20	<u>18-26.5 GHz</u> 1.35	<u>26.5-40 GHz</u> 1.70
All other In-Series Adapters		<u>0-4 GHz</u> 1.10	<u>4-12 GHz</u> 1.15	<u>12-18 GHz</u> 1.20
Semi-Rigid Right Angle Cabled Connectors				<u>0-18 GHz</u> 1.20
Field Replaceable Connectors (typical, measured back to back with seal pin)				<u>0-18 GHz</u> 1.15
Un-cabled Connectors (dependant on application)				Not Applicable

Insertion Loss: (dB maximum, tested at 10 GHz)

In-Series Adapters, Field Replaceable Connectors	$0.10 \sqrt{F}$ (GHz)
Semi-Rigid Cabled Connectors	$0.12 \sqrt{F}$ (GHz)
All other Un-cabled Connector	Not Applicable

Working Voltage: 335 Vrms maximum at sea level, 65 Vrms maximum at 70,000 feet

Dielectric Withstanding: Voltage: 500 Vrms minimum at sea level

RF High Potential Withstanding Voltage: 325 Vrms minimum at sea level, tested at 4 and 7 MHz

Corona Level: 190 Vrms minimum at 70,000 feet

Contact Resistance: (milliohms maximum initial, not applicable after environmental testing)

Center Contact (Connectors and Adapters)	6.0
Outer Contact (Connectors and Adapters)	2.0
Cable Shield to Body (Semi-Rigid Cabled Connectors Only)	0.5

Insulation Resistance: 5000 megohms minimum

RF Leakage: (dB typical, tested at 2.5 GHz)

Cabled and Field Replaceable Connectors	-80
In-Series Adapters	-65
All other Un-cabled Connectors	Not Applicable

MECHANICAL SPECIFICATIONS

Interface Design: MIL-STD-348A, Series SMP

Engagement Force: (pounds maximum, mated pair)

Full Detent (FD)	15.0
Limited Detent (LD)	10.0
Smooth Bore and Catcher's Mit (SM and CM)	2.0

Disengagement Force: (pounds minimum, mated pair)

Full Detent (FD)	5.0
Limited Detent (LD)	2.0
Smooth Bore and Catcher's Mit (SM and CM)	0.5

Mated Radial Misalignment: (inches maximum allowed, female adapters only)

Between Centerlines of Mating Planes (FD, LD, SM)010
Between Centerlines of Mating Planes (CM only)020

Mated Axial Misalignment: .010 inches maximum allowed between mating planes (female adapters only)

Durability: (mating cycles minimum)

Full Detent (all female connectors and adapters)	100
Limited Detent (female adapters only)	500
Smooth Bore and Catcher's Mit (female adapters only)	1000

Contact Retention: 1.5 pounds minimum axial force (captivated contacts only)

Cable Retention: (minimum)

	Axial Force* (lbs)	Torque (in-oz)
Cabled Connectors for RG-405 (.086 Semi-Rigid)	30	16.0
Cabled Connectors for M17/151 (.047 Semi-Rigid)	20	N/A

*Or cable breaking strength, whichever is less

Typical Measured Return Loss Bullet Adapter 127-0901-801

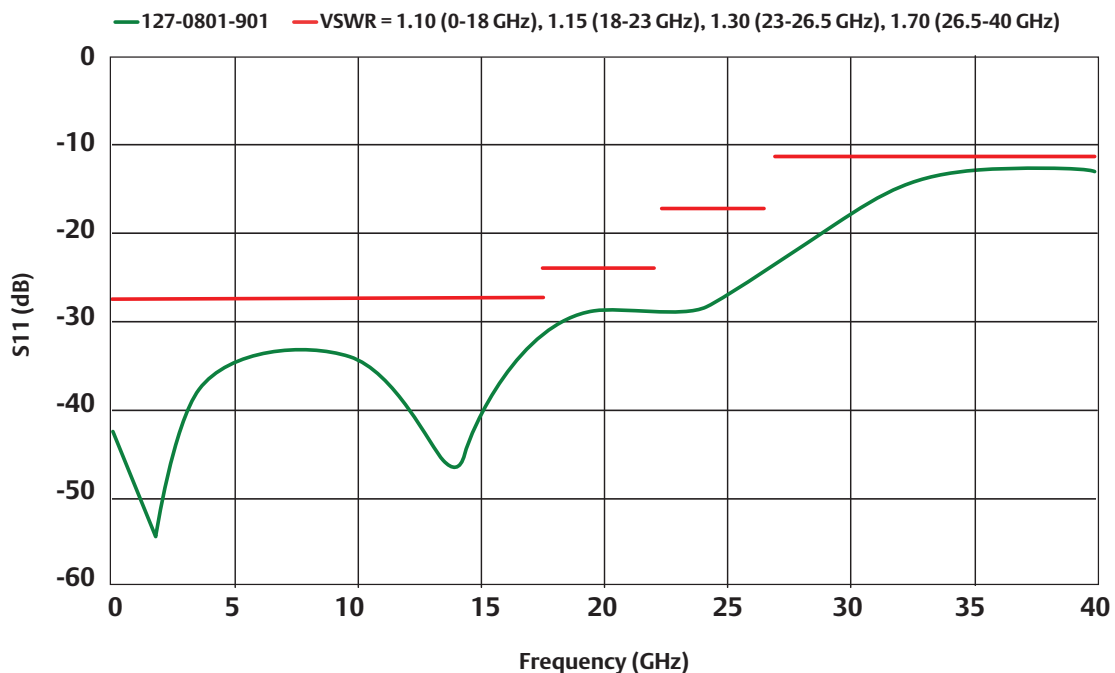

ENVIRONMENTAL SPECIFICATIONS

(Meets or Exceeds the Applicable Paragraph of MIL-PRF-39012)

Operating Temperature: -65°C to +165°C

Thermal Shock: MIL-STD-202, Method 107, Condition B (except high temp +165°C or max high temp of cable)

Corrosion: MIL-STD-202, Method 101, Condition B

Shock (specified pulse): MIL-STD-202, Method 213, Condition I

Vibration: MIL-STD-202, Method 204, Condition D

Moisture Resistance: MIL-STD-202, Method 106 (except step 7b omitted)

MATERIAL SPECIFICATIONS

Spring Finger (female) and End Launch (male) Bodies: Beryllium Copper per ASTM B196,
Gold* plated per MIL-DTL-45204 (.00005" min)

Hermetic Seal Bodies (male): Kovar Alloy per ASTM F15, Gold* plated per MIL-DTL-45204 (.00005" min)

All other Shroud Bodies (male): Stainless Steel, Type 303, per ASTM A582, Passivated per MIL-DTL-14072 (EL 300)

Connector and Adapter Contacts (male and female): Beryllium Copper per ASTM B196,
Gold* plated per MIL-DTL-45204 (.00005" min)

Hermetic Seal Center Pins: Kovar Alloy per ASTM F15, Gold* plated per MIL-DTL-45204 (.00005" min)

EMI/Anti-Rock Rings: Beryllium Copper per ASTM B196, Gold* plated per MIL-DTL-45204 (.00003" min)

PC Mount Legs: Brass per ASTM B16, Gold* plated per MIL-DTL-45204 (.00003" min)

Connector and Adapter Insulators: PTFE per ASTM D1710

Hermetic Seal Glass: Corning 7070

*All gold plated parts include a .00005" min nickel barrier layer.

MOUNTING HOLES

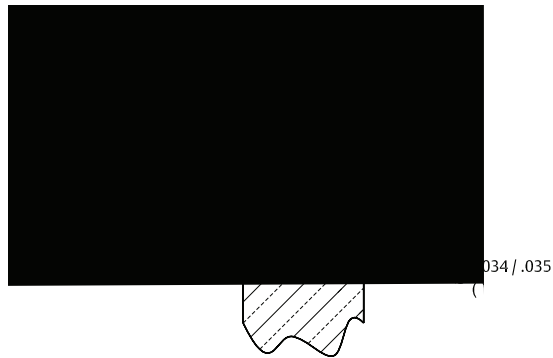
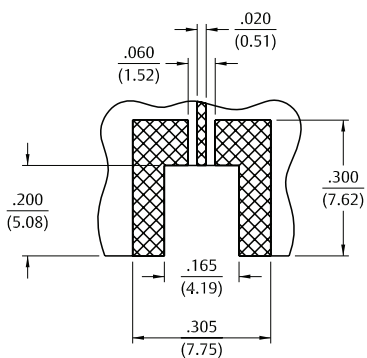

Mating Engagement for SMP Series per MIL-STD-348A

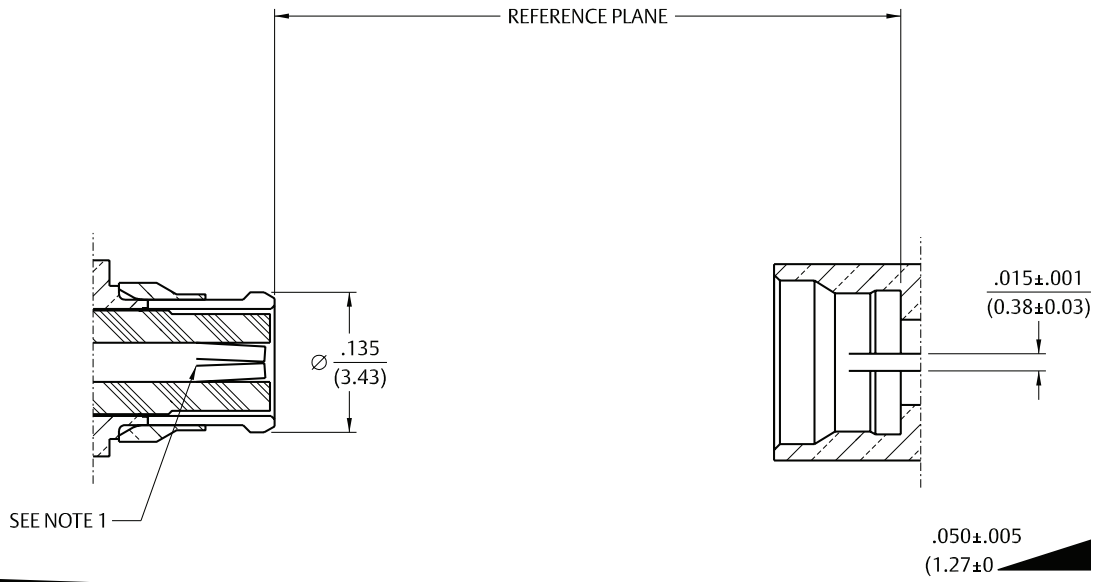

Light Solder Type Cabled Female

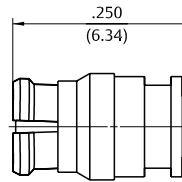

Type	VSWR & Freq. Range*	Gold Plated	Figure
.047 Semi-Rigid	1.20 Max 0-18 GHz, 1.35 Max 18-26.5 GHz, 1.70 Max 26.5-40 GHz	127-0692-001	1
.086 Semi-Rigid	1.20 Max 0-18 GHz, 1.35 Max 18-26.5 GHz, 1.70 Max 26.5-40 GHz	127-0693-001	2

Specifications dependant on cable ratings

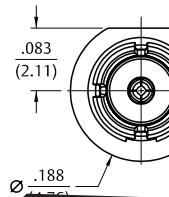

End Launch Male Receptacle – Surface Mount

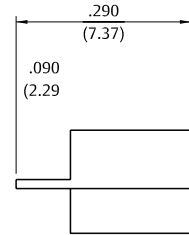
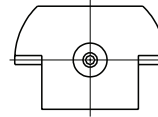
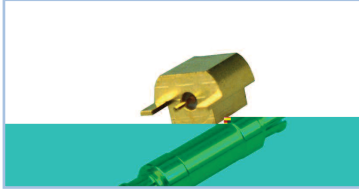

Interface	Freq. Range	Gold Plated	Packaging
Full Detent	0-18 GHz	127-0701-801	Stock
Full Detent	0-18 GHz	127-0701-802	Tape and Reel -1000 pieces
Limited Detent	0-18 GHz	127-1701-801	Stock
Limited Detent	0-18 GHz	127-1701-802	Tape and Reel -1000 pieces
Smooth Bore	0-18 GHz	127-2701-801	Stock
Smooth Bore	0-18 GHz	127-2701-802	Tape and Reel -1000 pieces

Mounting hole layout figure 1 on page 7.

2-Hole Flange Mount Male Field Replaceable



Interface	VSWR & Freq. Range*	Passivated	Accepts Pin Size
Full Detent	1.15 Typical 0-18 GHz	127-0701-612	.012 (.030)
Limited Detent	1.15 Typical 0-18 GHz	127-1701-612	.012 (.030)
Smooth Bore	1.15 Typical 0-18 GHz	127-2701-612	.012 (.030)

* Two connectors mated back to back with hermetic seal fixture

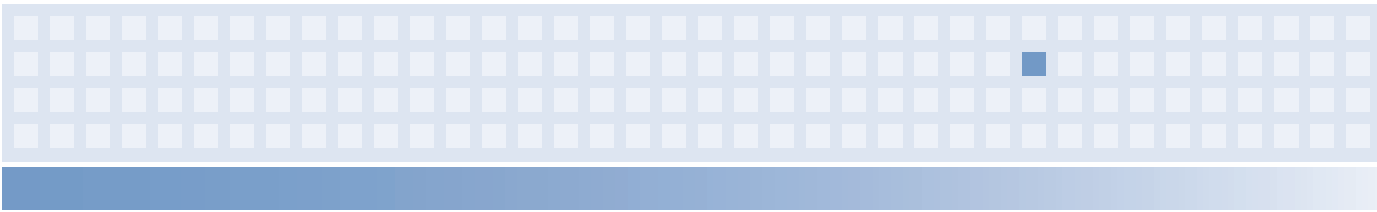

SMP Customer Tooling

Accurate assembly of the Semi-Rigid Cabled Connectors is obtained with the tools listed below. Industry standard devices are used if possible for customer convenience and tool compatibility.

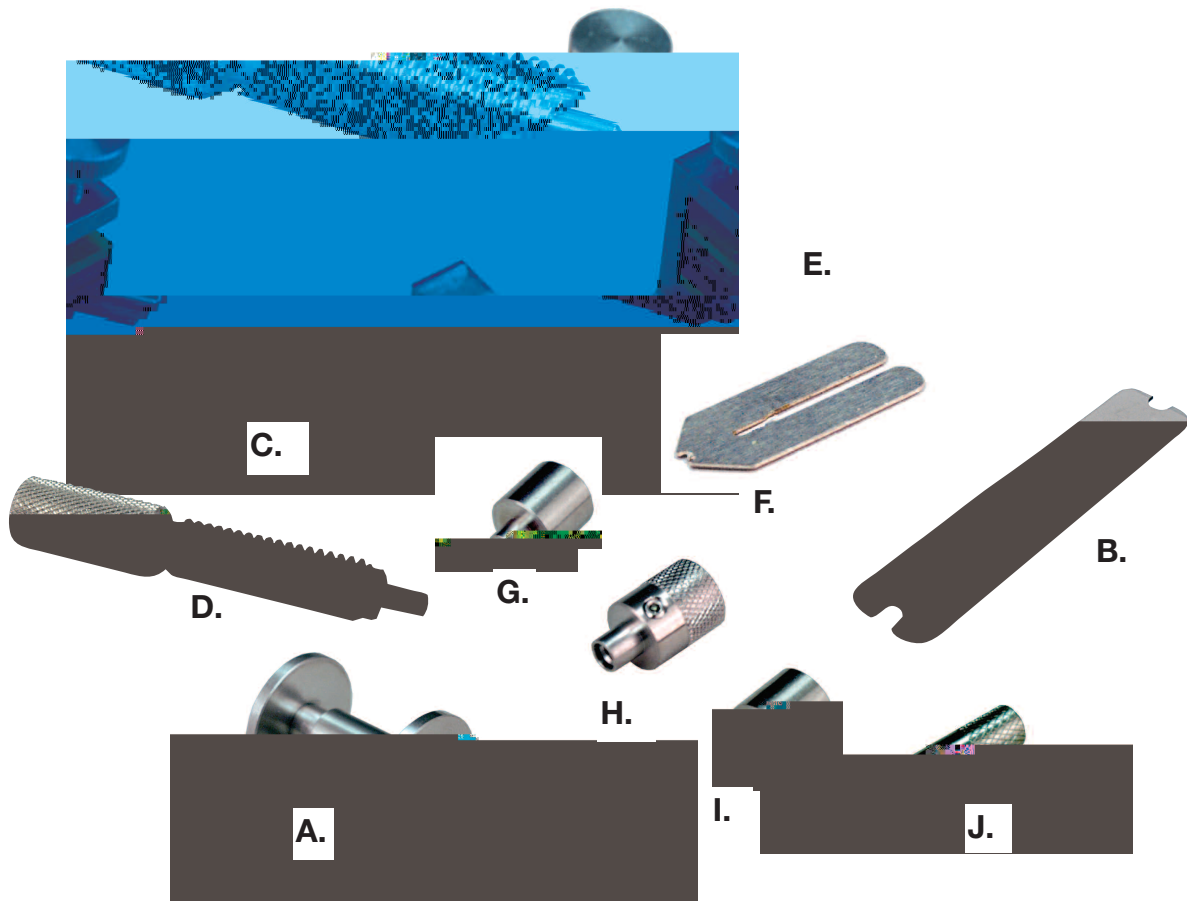

Item	Description	Part Number
A	SMP Bullet Extraction Tool	127-0000-900
B	SMP Cabled Connector Removal Tool	127-0000-901
C	Soldering Vise (does not include clamp inserts or stop screw)	140-0000-962
D	Stop Screw for Soldering Vise	140-0000-981
E	Semi-Rigid Cable Clamp Inserts for .086" OD Cable	140-0000-964
	Semi-Rigid Cable Clamp Inserts for .047" OD Cable	140-0000-997
F	Solder Shim for .086" OD Cable	140-0000-984
G	SMP Center Contact Holder	127-0000-902
H	SMP Interface Locator Tool	127-0000-903
I	SMP Right Angle Body Holder	127-0000-904
J	SMP FD Shroud Centering Tool	127-0000-905
	SMP LD Shroud Centering Tool	127-0000-906
	SMP SB Shroud Centering Tool	127-0000-907

ASSEMBLY INSTRUCTIONS

SMP Straight Female Solder Style for .047 OD Semi-Rigid Cable

- 1 Identify tools (5 piece parts) and connector parts (3 piece parts).
- 2 Strip cable jacket and dielectric to dimension shown. Do not nick center conductor. Clean all debris from prepared cable.
- 3 Insert center conductor into cable stop as shown and place contact onto center conductor.
- 4 Insert contact into contact holder fixture and clamp cable g(A

Cable Group	Part Number
MIL-C-17/151, .047 Semi-Rigid	127-0692-001

Tool	Part Number
Cable Vise	140-0000-962
Stop Screw	140-0000-981
Clamp Inserts	140-0000-997
Contact Holder	127-0000-902
Interface Location Fixture	127-0000-903

SMP Right Angle Female Solder Style for .0478mm SFRs

Cable Group	Part Number
MIL-C-17/151, .047 Semi-Rigid	127-0692-101

Tool	Part Number
Cable Vise	140-0000-962
Stop Screw	140-0000-981
Clamp Inserts	140-0000-997
Body Holder	127-0000-904
Interface Location Fixture	127-0000-903

SMP Straight Female Solder Style for .086 OD Semi-Rigid Cable

1. Identify tools (6 piece parts) and connector parts (2 piece parts).
2. Strip cable jacket and dielectric to dimension shown. Do not nick center conductor. Clean all debris from prepared cable.
3. Place contact onto center conductor, insert solder shim between cable jacket and contact.
4. Insert contact into contact holder fixture and clamp cable in vise. Tighten stop screw until light pressure is applied between contact, solder shim and cable jacket.
5. Solder contact to center conductor through solder hole using .016 (0.41) diameter flux core solder wire or solder paste. Use a minimum amount of solder and heat for a good joint. Do not allow heat to build up for a long period of time as cable dielectric will expand.
6. After solder joint has cooled, remove solder shim and cable from vise. Remove any excess solder from contact with a sharp blade and clean all debris from contact and cable.
7. Insert contact into connector assembly, making sure cable jacket bottoms out against internal shoulder of connector body. Insert connector assembly into interface location fixture and clamp cable in vise. Make sure connector assembly is fully engaged within location fixture. Tighten stop screw until light pressure is applied between connector assembly and cable jacket.
8. Solder end of connector body to cable jacket, using a minimum amount of solder and heat for a full fillet joint. Allow assembly to cool before removing connector from vise and location fixture. Best results are obtained when contact location is flush to .004 (0.10) recessed from reference plane. Interface location fixture is pre-set at factory, but can be adjusted to control location.

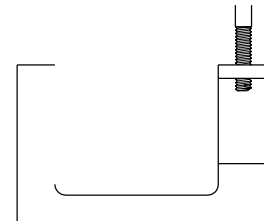

Cable Group	Part Number
RG-405, .086 Semi-Rigid	127-0693-001

Tool	Part Number
Cable Vise	140-0000-962
Stop Screw	140-0000-981
Clamp Inserts	140-0000-964
Solder Shim	140-0000-984
Contact Holder	127-0000-902
Interface Location Fixture	127-0000-903

SMP Right Angle Female Solder Style for .086 OD Semi-Rigid Cable

1. Identify tools (5 piece parts) and connector parts (2 piece parts).
2. Strip cable jacket and dielectric to dimension shown. Do not nick center conductor. Clean all debris from prepared cable.
3. Make sure slot in connector contact is aligned with cross hole in body as shown. Insert cable into cross hole in connector body, making sure cable jacket bottoms out against internal shoulder of connector body.
4. Insert connector assembly into interface location fixture and clamp cable in vise using body holder fixture as shown. Tighten stop screw until light pressure is applied between connector body and cable jacket.
5. Solder contact to center conductor through rear access port in connector body using a minimum amount of solder and heat for a good joint. Do not allow solder to build up along exposed center conductor.
6. After center conductor solder joint has cooled, solder connector body to cable jacket, using a minimum amount of solder and heat for a full fillet joint. Take care so that solder does not flow onto anti-rock ring or into rear access port. Allow assembly to cool before removing connector from vise and location fixture.
7. Using a fixture plate.

Cable Group	Part Number
RG-405, .086 Semi-Rigid	127-0693-101

Tool	Part Number
Cable Vise	140-0000-962
Stop Screw	140-0000-981
Clamp Inserts	140-0000-964
Body Holder	127-0000-904
Interface Location Fixture	127-0000-903

SMP Hermetic Seal Installation

1. Prepare housing panel per figure 2 as shown on page 7.
2. Install solder ring on hermetic seal as shown. Recommended ring size is .103 (2.62) ID x .128 (3.25) OD x .015 (0.38) Thick.
3. Solder in place as shown.

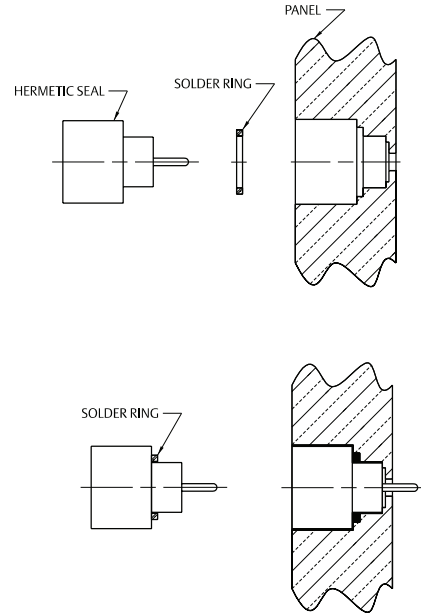

Interface	Part Number
Full Detent	127-0711-601
Limited Detent	127-1711-601
Smooth Bore	127-2711-601

SMP Shroud Installation

1. Install appropriate assembly tool into shroud as shown.
2. While holding tool in place, align flange mount with mounting holes in panel. Install fasteners and torque to 6-8 in/lbs.



Shroud Part Number	Tool Part Number
127-0701-602	127-0000-905
127-1701-602	127-0000-906
127-2701-602	127-0000-907
127-3701-602	127-0000-907

COMPETITOR CROSS REFERENCE

Description	Johnson	Tensolite	Corning Gilbert	Micro-Mode	SV Microwave	AEP	Rosenberger
Straight Female M17/151 (.047 SR) Cabled	127-0692-001	P651-1CC	A014-B11-01	MMSP-6120	1203-4000	7500-1582-011	19K101-270E4
Straight Female RG 405 (.086 SR) Cabled	127-0693-001	P651-2CC	A014-D11-01	MMSP-2508	1204-4000	7500-1562-010	19K101-271E4
Right Angle Female M17/151 (.047 SR) Cabled	127-0692-101	P652-1CC	A015-B11-01	MMSP-6968	1213-4006	7501-1562-011	19K202-270E4
Right Angle Female RG 405 (.086 SR) Cabled	127-0693-101	P652-2CC	A015-D11-01	MMSP-2598	1214-4001	7501-1562-010	19K202-271E4
Field Replaceable .012 Socket 2 Hole Flange Male FD	127-0701-612	P836-4CCF			SF1250-6000		
Field Replaceable .012 Socket 2 Hole Flange Male LD	127-1701-612	P836-5CCF					
Field Replaceable .012 Socket 2 Hole Flange Male SB	127-2701-612	P836-6CCF					
Adapter Bullet Female/Female .254	127-0901-801	P650-1CC	A1A1-0001-01	MMSP-2500	1290-4004	5280-1502-000	19K101-K00E4
Adapter Female/Female .769	127-0901-811	P617-1CC		MMSP-3829	1290-4007	5280-1502-001	19K115-K00E4
Adapter Male CM/Male FD	127-0901-822	P912-1CCSF	A3A6-0539-01				
Adapter Male CM/Male LD	127-1901-822	P912-2CCSF					
Adapter Male CM/Male SB	127-2901-822	P912-3CCSF			SF1293-6004		
Shroud 2 Hole Flange .165 Wide x .400 High FD	127-0701-602	P670-3SF	A001-A23-04	MMSP-2514	SF1254-6006		
Shroud 2 Hole Flange .165 Wide x .400 High LD	127-1701-602	P672-3SF	A001-A24-04	MMSP-6095	SF1254-6007		
Shroud 2 Hole Flange .165 Wide x .400 High SB	127-2701-602	P673-3SF	A001-A25-04	MMSP-6067	SF1254-6008		
Shroud 2 Hole Flange .235 Wide x .470 High CM	127-3701-602	P671-1SF					
PC Mount Straight .218 OD .100 Legs Male FD	127-0701-201	P654-5CC	A008-L33-01	MMSP-7448	SF1287-6001		
PC Mount Straight .218 OD .100 Legs Male LD	127-1701-201	P654-6CC	A008-L34-01	MMSP-7449			
PC Mount Straight .218 OD .100 Legs Male SB	127-2701-201	P654-7CC	A008-L35-01				
PC Mount Straight .235 OD .100 Legs Male CM	127-3701-201	P654-8CC					
End Launch Surface Mount Male FD	127-0701-801	P606-1CC	A010-L13-02	MMSP-7457			
End Launch Surface Mount Male LD	127-1701-801	P606-2CC	A010-L14-02	MMSP-3805			19S202-40ME4
End Launch Surface Mount Male SB	127-2701-801	P606-3CC	A010-L15-02	MMSP-7347			
Hermetic Feedthrough Shroud Male FD	127-0711-601	P840-9CC	A007-L43-01-70	MMSP-2771			
Hermetic Feedthrough Shroud Male LD	127-1711-601	P794-2CC	A007-L44-01-70	MMSP-2875			
Hermetic Feedthrough Shroud Male SB	127-2711-601		A007-L45-01-70	MMSP-2979			

Emerson Network Power Connectivity Solutions

Johnson

299 Johnson Avenue
Waseca, MN 56093
USA

Tel: 800.247.8256
Fax: 507.833.6287

www.EmersonNetworkPower.com/Connectivity

About Emerson Network Power Connectivity Solutions

Emerson Network Power Connectivity Solutions, an Emerson business, serves the needs of wireless communications, telephony and data networks, CATV, security systems, health care and industrial facilities with a full spectrum of broadband copper and fiber optic connectivity products. For more information, visit www.EmersonNetworkPower.com/Connectivity

About Emerson

Emerson (NYSE: EMR), based in St. Louis, is a global leader in bringing technology and engineering together to provide innovative solutions to customers through its network power, process management, industrial automation, climate technologies, appliance and tools businesses. For more information, visit www.Emerson.com

Emerson Network Power

The global leader in enabling business-critical continuity.

- AC Power Systems
- Connectivity
- DC Power Systems
- Embedded Power
- Inbound Power
- Integrated Cabinet Solutions
- Outside Plant
- Precision Cooling
- Site Monitoring and Services

EmersonNetworkPower.com