

ISL88731EVAL2Z and ISL88731CEVAL2Z Evaluation Boards Setup Procedure

Introduction

The ISL88731 and ISL88731C are highly integrated battery charger controllers for Li-ion/Li-ion polymer batteries with SMBus interface controlling charge voltage, charge current and input current limiting. The evaluation board includes a USB to SMBus interface to allow users to control the ISL88731 or ISL88731C from a Personal Computer.

What's Inside

This Evaluation Board Kit contains the following materials:

- Qty (1) ISL88731EVAL2Z or ISL88731CEVAL2Z Evaluation Board
- Qty (1) USB cable

What is Needed

The following materials are recommended to perform testing:

- One AC adaptor or one adjustable 25V/6A DC power supply
- Two adjustable electronic loads with constant current mode and constant voltage mode
- One Volt Meter
- One 500MHz four-channel oscilloscope with voltage and current probes
- A Personal Computer (PC) with ISL88731(C) control software and drivers (all available on the self extracting archive file ISL88731_v3.0_Installer.exe available for download from www.Intersil.com)

Note: The National Instruments Runtime Engine must be installed before connecting the evaluation board to your PC. The Runtime Engine contains driver files required by the New Hardware Wizard.

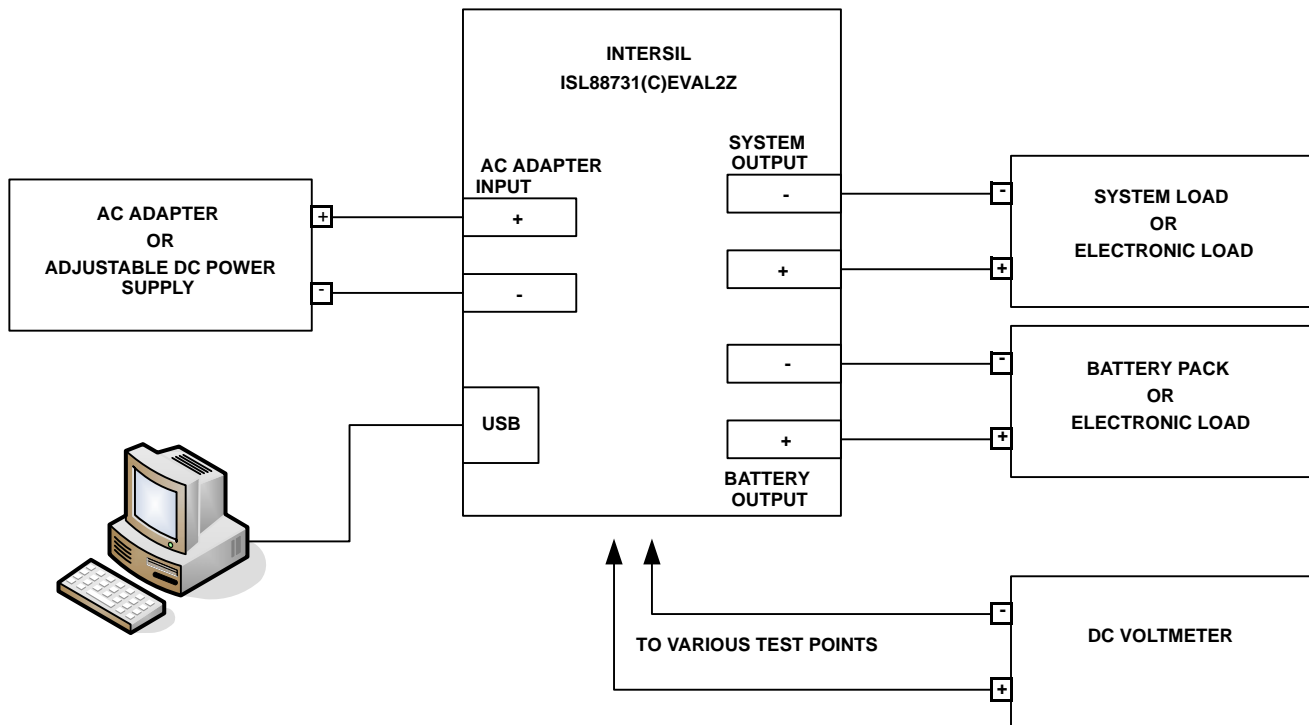

FIGURE 1. ISL88731(C)EVAL2Z HARDWARE CONNECTION DIAGRAM

Application Note 1404

Download, Extract and Install the Software

Download the self extracting archive file ISL88731_v3.0_Installer.exe. The URL for the file is: http://www.intersil.com/data/ev/isl88731_control_v3_sw_installer.zip

It will create a folder ("ISL88731 Installer") in the folder that holds the self extracting file. A dialog box will give you the opportunity to change the location of the extracted files.

Make a note of the location of the folder. You will need to direct the New Hardware Wizard to this folder for the driver.

Software Installation

Both the ISL88731(C) control program and the National Instruments run time engine are installed from the "ISL88731 Installer" folder. Navigate to the folder and double click the "AutoRun.exe" file. You should see the window as shown in Figure 2.

Click on the "Install or Uninstall ISL88731 Control Software" to run the Installation Wizard.

You should now see a window as shown in Figure 3.

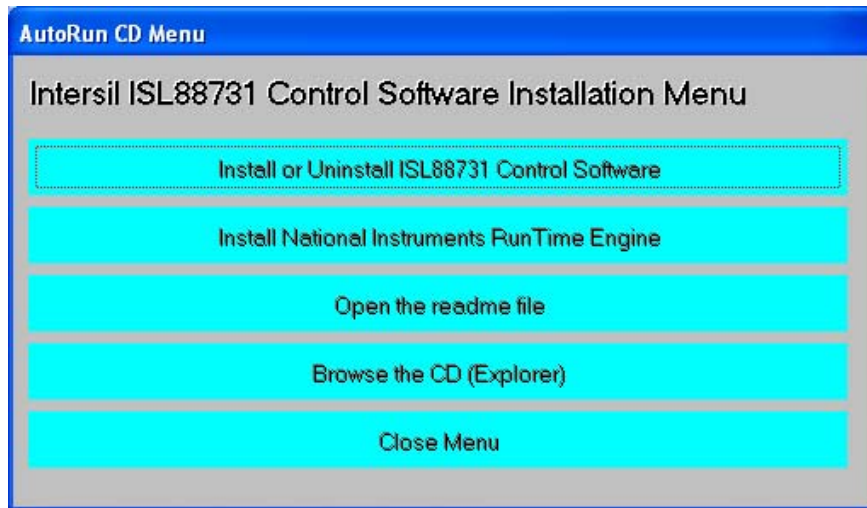

FIGURE 2. ISL88731(C)EVAL2Z CONTROL SOFTWARE INSTALLATION MENU

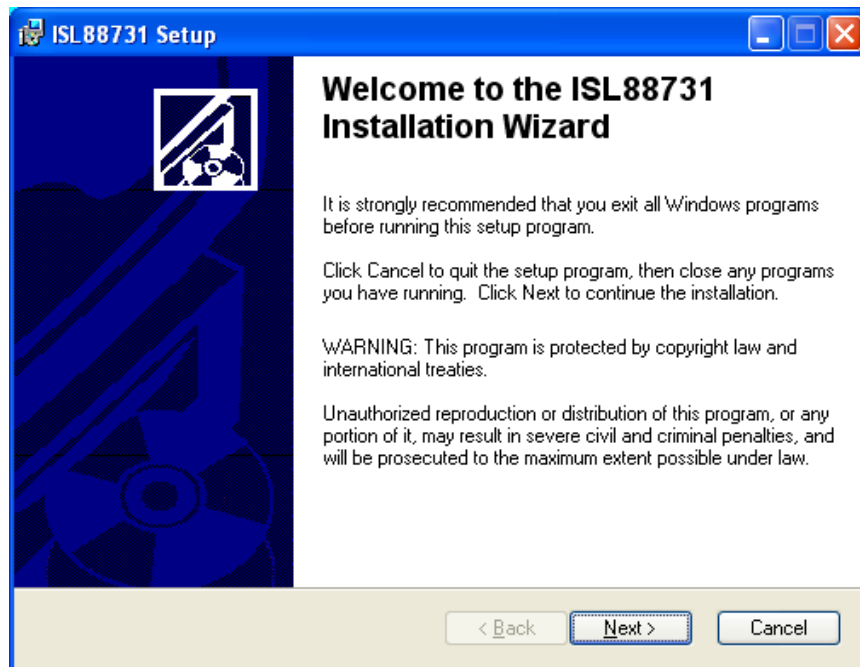

FIGURE 3. ISL88731(C)EVAL2Z CONTROL SOFTWARE INSTALLATION WIZARD

Application Note 1404

In most PCs the National Instruments Runtime Engine will be installed automatically after the ISL88731(C) control software. You should see the window as shown in Figure 4.



FIGURE 4. NATIONAL INSTRUMENTS RUNTIME ENGINE INSTALLATION WIZARD

Follow the instructions to install the Runtime Engine. If it does not run automatically, click “Install National Instruments Runtime Engine” on the ISL88731(C)EVAL2Z Control Software Installation Menu (see Figure 2). After installation, click on the Close Menu button.

Driver Installation

Connect the ISL88731(C)EVAL2Z to the USB port of your PC.

Note: The SMBus part of the ISL88731(C) and the USB-SMBus interface are powered by the 5V from the USB port on the PC. It is not necessary to have other power supplies connected to the evaluation board to read or write to the ISL88731(C).

When WINDOWS detects new hardware, the new hardware wizard should appear. Direct it to look for the driver information file in the “ISL88731 Installer” folder (extracted from the downloaded file). In some systems, it may be necessary to specify the driver information file (USB-I2C_WDM.inf).

Run the ISL88731 Application

ISL88731(C) control software should now appear in your Start/All Programs list. Click on it to run the application.

Application Note 1404

Figure 5 shows a screen shot of the ISL88731(C) control software user interface.

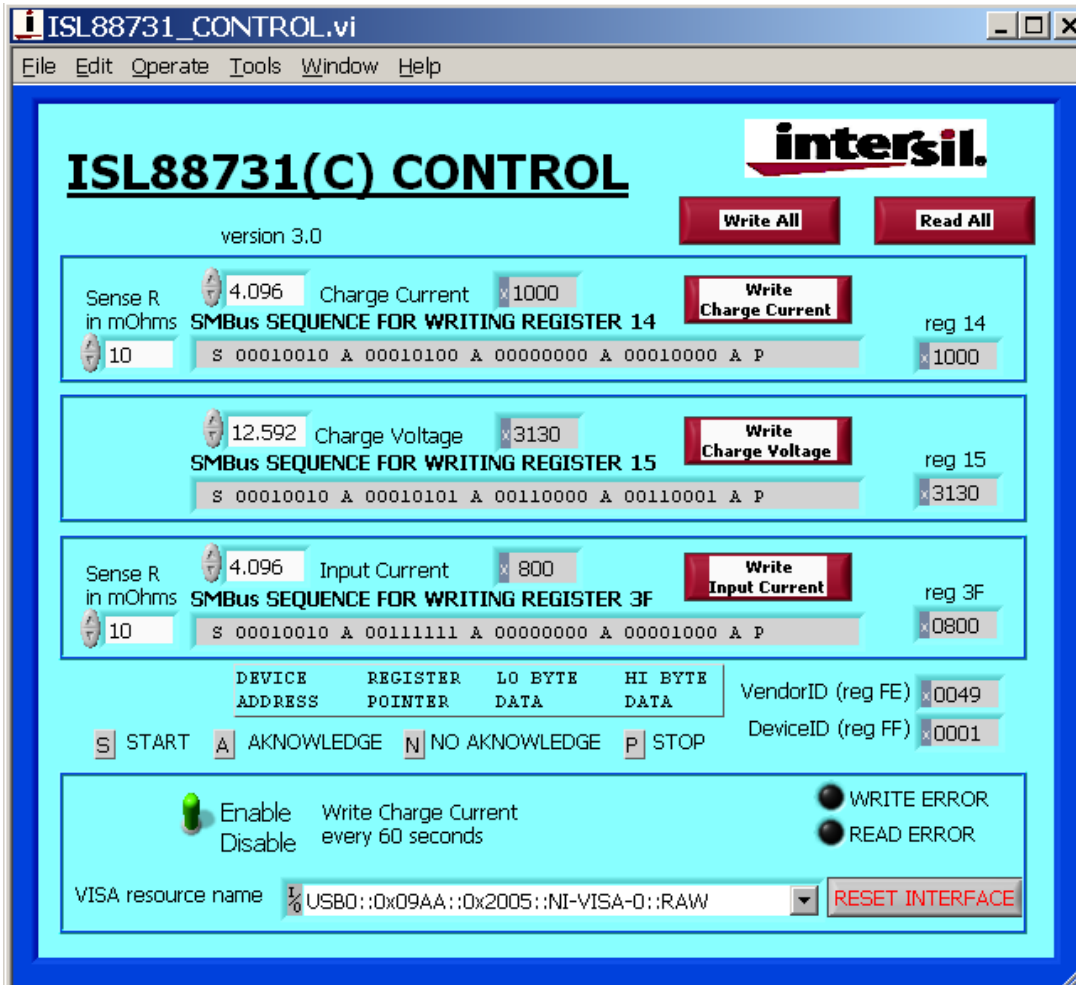

FIGURE 5. ISL88731(C)EVAL2Z CONTROL SOFTWARE SCREEN SHOT

Application Note 1404

Enable the Output

When power is applied to the ISL88731(C), the Charge Current and Charge Voltage Registers are 0x0000 and the output is disabled. The output is enabled by writing valid, non-zero values to these 2 registers. See the ISL88731(C) datasheet for valid values.

The ISL88731(C) is also disabled if the ACIN pin is below 3.2V. An Input voltage >13.1V will pull ACIN above 3.2V. The minimum input voltage can be adjusted on the evaluation board by changing R₆ or R₇ (see Figure 10).

Description of the User Interface Controls and Display Information

Clicking the “Write All” button will write the indicated SMBus sequences to Registers 14, 15 and 3F in the ISL88731(C).



Clicking on the “Read All” button will read all 5 registers in the ISL88731(C) and display the results in the grey indicators below the “Read All” button.



If the device and the interface are operating normally, the VendorID (reg FE) and the DeviceID (reg FF) will display as follows:

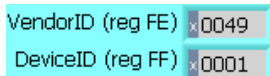

If the VendorID (reg FE) and DeviceID (reg FF) remain 0000 it indicates a communication problem.

If the Visa resource name is blank, it indicates a problem with the USB communication.

Clicking on the “RESET INTERFACE” button may correct the problem. If not, try closing the software, remove power and USB connections from the evaluation board, then reconnect and restart.

Note the register contents in the user interface are updated ONLY when the “Read All” button is clicked.

The “Write Charge Current” button sends only the charge current command to the ISL88731(C). Other registers are unchanged.



The small white window next to “Charge Current” accepts inputs in Amps, and converts them the hexadecimal (hex) value to be written to the ISL88731(C) in the grey window.

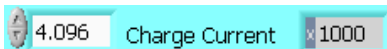

The hex value depends on the value entered in Sense R.

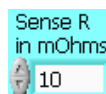

The value in the white window will be forced to the nearest valid number that can be produced by the DAC in the ISL88731(C). That is, after entering 4 and hitting the enter key, the display will change to 3.968. After entering 4.1 and hitting

the enter key, the display will change to 4.096. The value can be incremented and decremented with the up/down arrows at the left of the window.

The Sense R inputs are used to calculate the hexadecimal (hex) values and the SMBus sequences for the Charge Current limit and Input Current limit entered in the white boxes. The evaluation board is built with 10mΩ sense resistors. If you change them to another value, enter the new value to get correct calculations.

After entering a number in the white box, hitting the enter key or clicking on another area will enter the value and the resulting hex value and the SMBus sequence will be calculated and displayed.

SMBus SEQUENCE FOR WRITING REGISTER 3F

S 00010010 A 00111111 A 00000000 A 00001000 A P			
DEVICE ADDRESS	REGISTER POINTER	LO BYTE DATA	HI BYTE DATA

S = the Start condition, A = the Acknowledge, P = the Stop condition.

Note: The LO byte is sent first. The HI byte is sent second.

When writing 0x41A0, 0xA0 is written first and 0x41 is sent second.

Important Note: The SMBus commands are NOT sent until one of the WRITE buttons is clicked (i.e. Write All or Write Charge Current).

The “Write Charge Voltage” button writes only the Charge Voltage register. Other registers are unchanged.

The small white window accepts Charge Voltage (in Volts) and calculates the hexadecimal value and the SMBus sequence to write to the ISL88731(C). The SMBus command is sent when the “Write Charge Voltage” or “Write All” button is clicked. See Figure 8.

The “Write Input Current” button writes only the Input Current register. Other registers are unchanged. The small white window accepts Input Current Limit in Amps and calculates the hex value and the SMBus sequence to be written to the ISL88731(C). The Sense R input is used to calculate the hex value and the SMBus sequence. The SMBus command is sent when the “Write Input Current” or “Write All” button is clicked. See Figure 9.

The ISL88731(C) will shut down unless it receives Charge Voltage or Charge Current commands every 175s. This is a safety feature that prevents overcharging batteries if bus master has stopped functioning. The control software includes the function to write the Charge Current register every 60 seconds, which can be enabled or disabled as shown in Figure 6 and Figure 7.

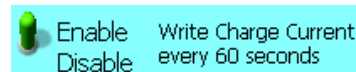

FIGURE 6. ENABLE WRITING CHARGE CURRENT REGISTER EVERY 60 SECONDS

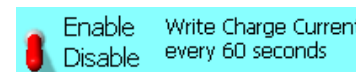

FIGURE 7. DISABLE WRITING CHARGE CURRENT REGISTER EVERY 60 SECONDS

Application Note 1404

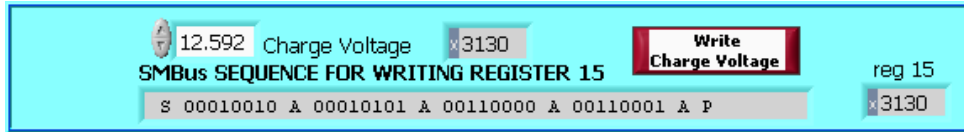

FIGURE 8. WRITE CHARGE VOLTAGE BLOCK



FIGURE 9. WRITE INPUT CURRENT BLOCK

Interface Troubleshooting

When the evaluation board is connected to the PC by a USB cable and the software is running, the software assigns a VISA resource name.

If this window is blank, it indicates a problem with communication between the PC and the micro controller on the evaluation board. Check and correct the connection of the USB cable to your PC and the evaluation board. Click on the "RESET INTERFACE" button.

If you still get no VISA resource name, Close and restart the ISL88731(C) control software.

If you still get no VISA resource name, Open the Device Manager (Control Panel/System/Device Manager) with the ISL88731(C)EVAL2Z evaluation board connected to your USB port. You should see a device named "NI-VISA USB Device". If it is not in the list of devices, the driver may not be correctly installed. Run the New Hardware wizard.

If you still get no VISA resource name, contact your Intersil Field Application Engineer for assistance.

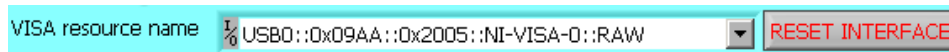

Application Note 1404

TABLE 1. ISL88731(C)EVAL2Z BILL OF MATERIALS

REF DES	PART NUMBER	VALUE	MANUFACTURER	DESCRIPTION
C1, C10, C11	H1045-00105-6R3V10	1 μ F	GENERIC	Multilayer Capacitor
C24	H1044-00104-16V10	0.1 μ F	GENERIC	Multilayer Capacitor
C2-C4, C7	H1045-00103-25V10	0.01 μ F	GENERIC	Multilayer Capacitor
C304, C308	H1045-00105-6R3V10	1 μ F	GENERIC	Multilayer Capacitor
C5	H1046-00105-25V10	1 μ F	GENERIC	Multilayer Capacitor
C6, C16	H1045-00104-25V10	0.1 μ F	GENERIC	Multilayer Capacitor
C8	H1045-00224-25V20	0.22 μ F	GENERIC	Multilayer Capacitor
C9	H1045-00473-25V10	0.047 μ F	GENERIC	Multilayer Capacitor
D1, D2	BAT54		DIODES	30V Schottky Diode
J1, J6, J8	164-6218		MOUSER	Single Point RA PCB Mount (Black)
J2, J5, J7	164-6219		MOUSER	Single Point RA PCB Mount (Red)
J9, TP25	131-4353-00		TEKTRONIX	Scope Probe Test Point PCB Mount
L1	HM65-8R2	8.2 μ H	BI-Tech	Shielded SMD Inductor
Q1	SI4835BDY		VISHAY	30V, -7.4A P-Channel MOSFET
Q2	BSS138LT1		ON-SEMI	200mA 50V N-Channel Power MOSFET
R1, R3	H2511-00100-1/16W5	10	GENERIC	Thick Film Chip Resistor
R10	H2511-01002-1/10W5	10k	GENERIC	Thick Film Chip Resistor
R13	H2511-00R00-1/16W1	0	GENERIC	Thick Film Chip Resistor
R17	H2511-004R7-1/16W5	4.7	GENERIC	Thick Film Chip Resistor
R18	H2511-00R00-1/16W	0	GENERIC	Thick Film Chip Resistor
R2, R4	H2511-01003-1/16W1	100k	GENERIC	Thick Film Chip Resistor
R20	H2511-01000-1/16W5	100	GENERIC	Thick Film Chip Resistor
R23	H2511-00220-1/16W5	22	GENERIC	Thick Film Chip Resistor
R30	H2511-01001-1/16W5	1k	GENERIC	Thick Film Chip Resistor
R310, R311	H2511-01801-1/16W5	1.8k	GENERIC	Thick Film Chip Resistor
R5, R19, R24	WSL2512R0100FEA	0.01	VISHAY	Power Metal Strip Resistor
R6, R11	H2511-01003-1/10W5	100k	GENERIC	Thick Film Chip Resistor
R7	H2511-03302-1/16W5	33k	GENERIC	Thick Film Chip Resistor
U1	ISL88731HRTZ or ISL88731CHRTZ		INTERSIL	SMBus Level 2 Battery Charger
C12	C1608X7R1H104M	0.1 μ F	TDK	Multilayer Capacitor
C13-C15, C17	H1065-00106-25V20	10 μ F	GENERIC	Multilayer Capacitor
C305, C307, C309	H1045-00104-16V10	0.1 μ F	GENERIC	Multilayer Capacitor
F325	MICROSMD050F		RAYCHEM-TYCO	PolySwitch SM Resettable Fuse
J301	897-30-004-90-000		MIL-MAX	Type B Receptacle USB Connector
Q8, Q9, Q11	IRF7821PBF		IR	30V, +13.6A N-Channel HEXFET Power MOSFET
R302, R303, R307, R309, R399	H2511-00R00-1/16W1		GENERIC	Thick Film Chip Resistor
R304, R305	H2511-01001-1/16W1	1k	GENERIC	Thick Film Chip Resistor
U301	C8051F320		SILICON LABRATORIES	General Purpose MicroControllers
U303	SN65220DBV		TI	SINGLE USB Port Transient Suppressors

ISL88731(C)EVAL2Z Evaluation Board Layout

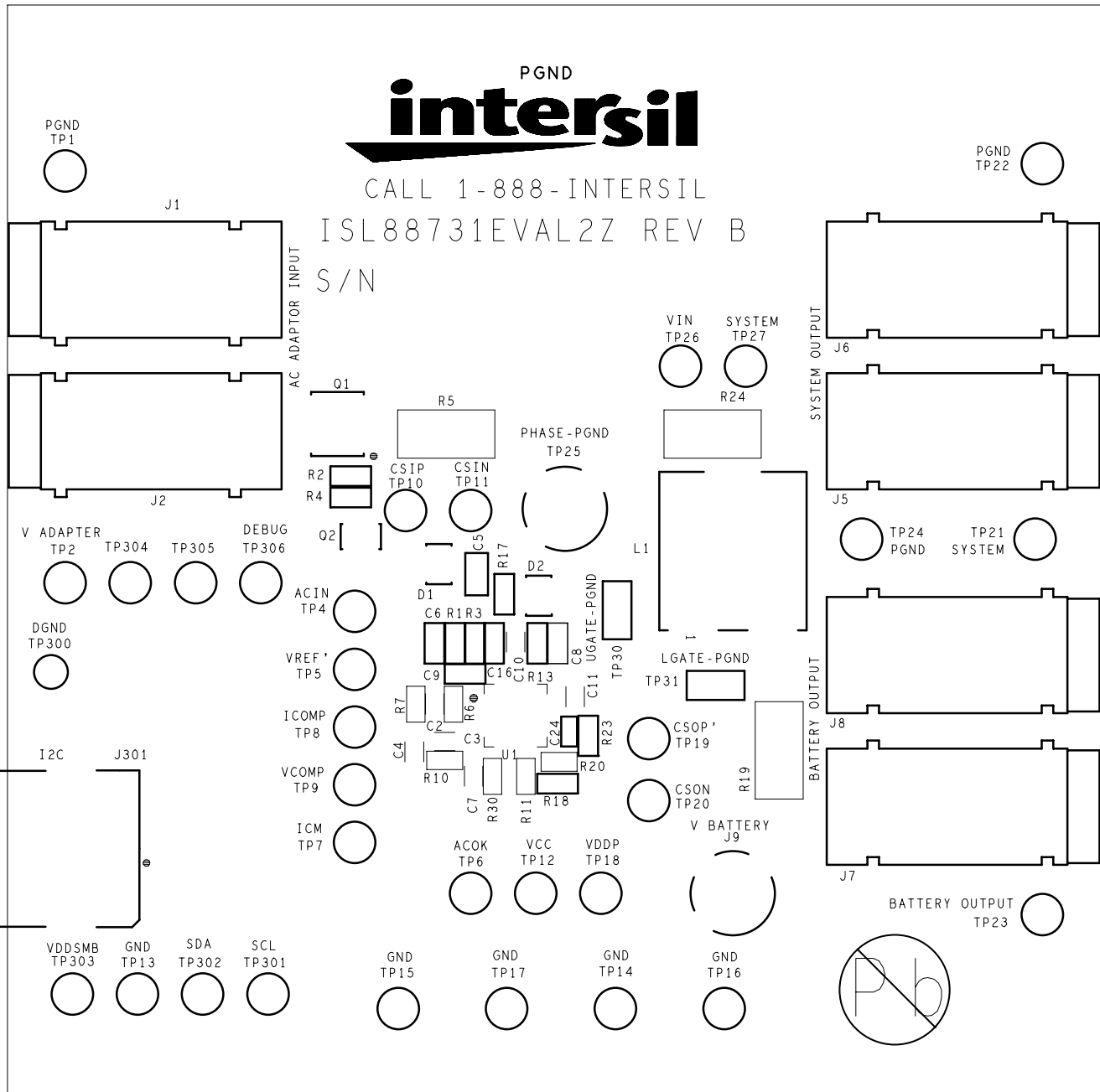

FIGURE 12. TOP SILK SCREEN

ISL88731(C)EVAL2Z Evaluation Board Layout (Continued)

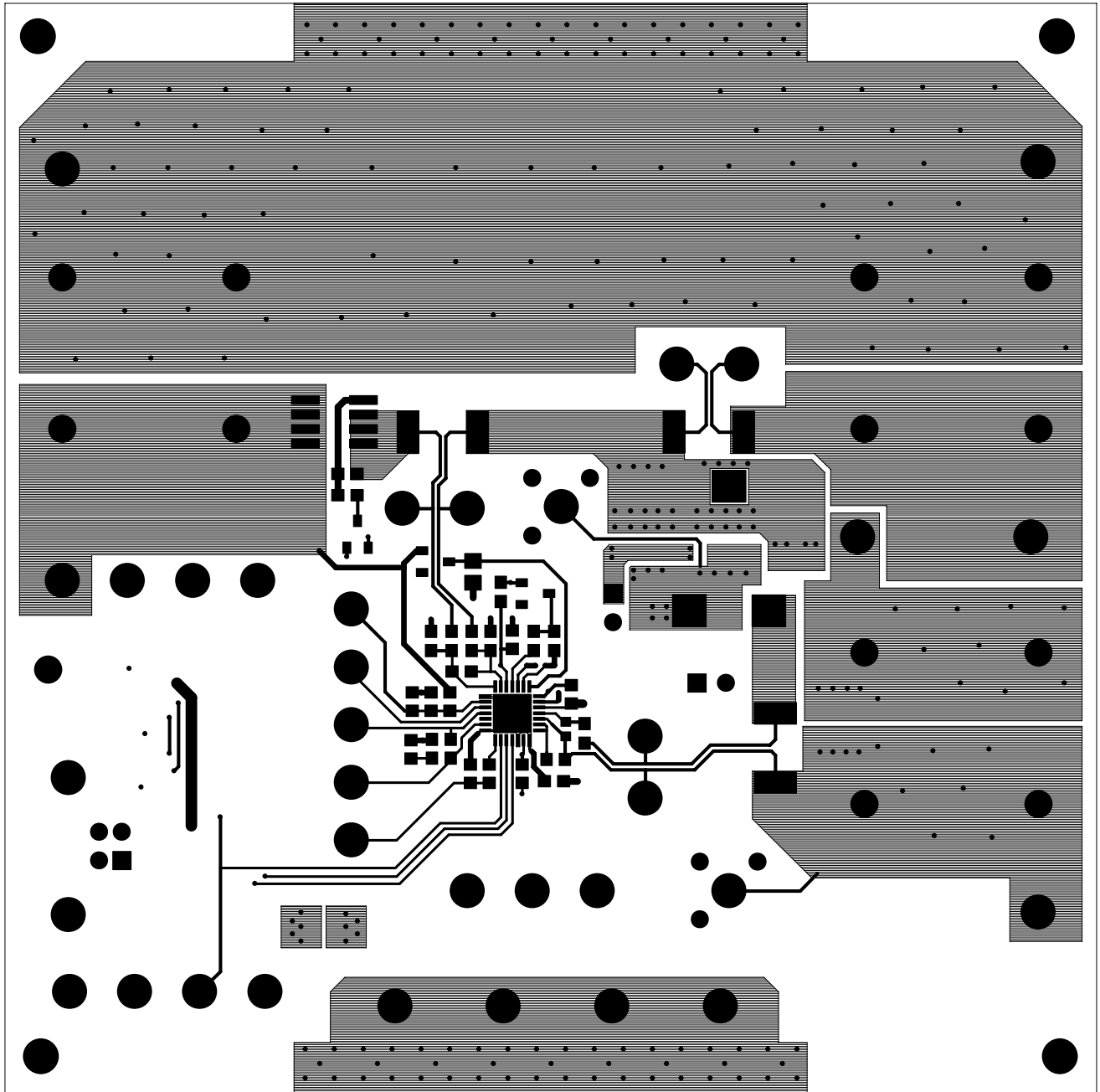

FIGURE 13. TOP COPPER

ISL88731(C)EVAL2Z Evaluation Board Layout (Continued)

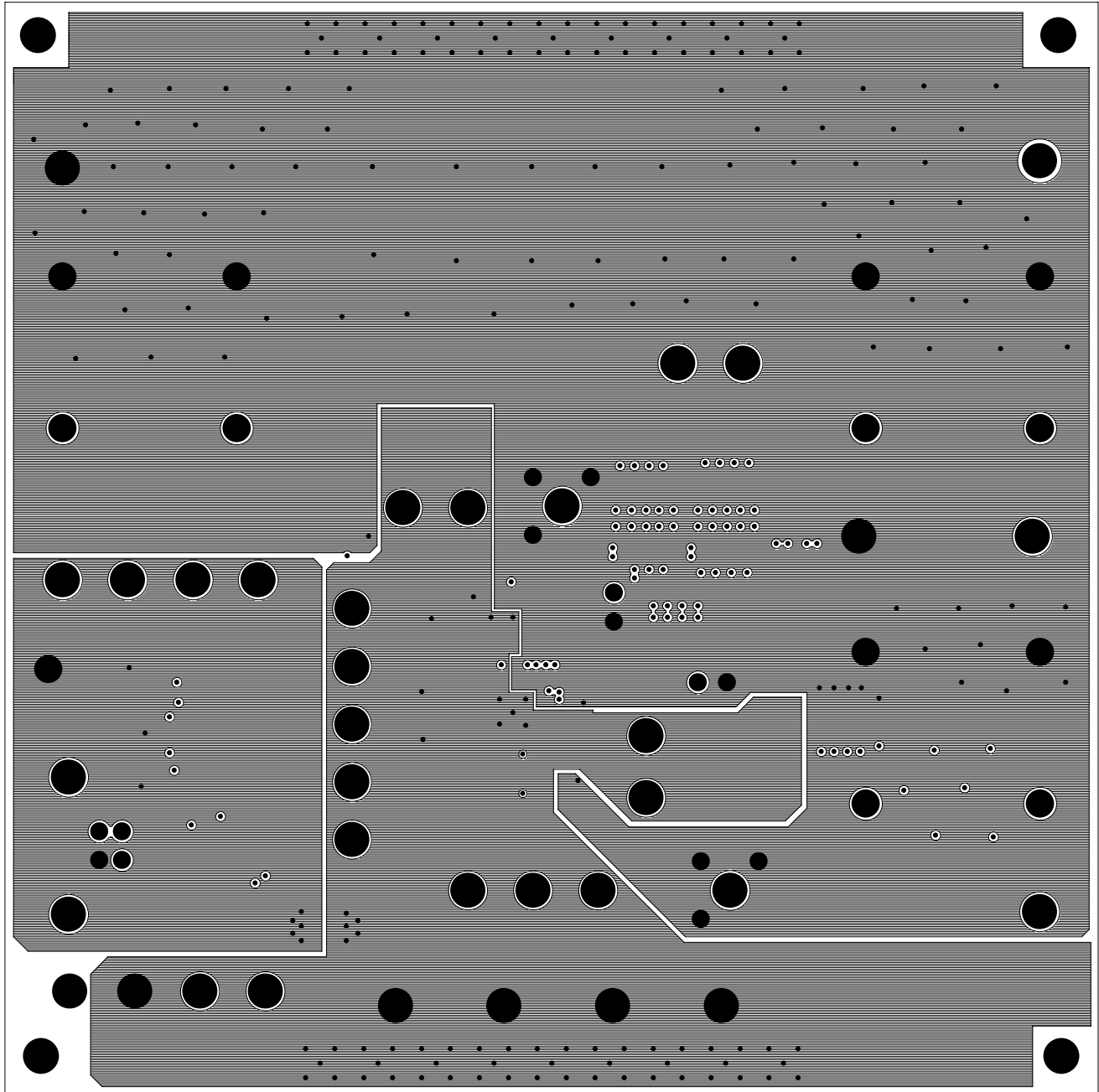

FIGURE 14. LAYER 2 (GROUNDS) (TOP VIEW)

ISL88731(C)EVAL2Z Evaluation Board Layout (Continued)

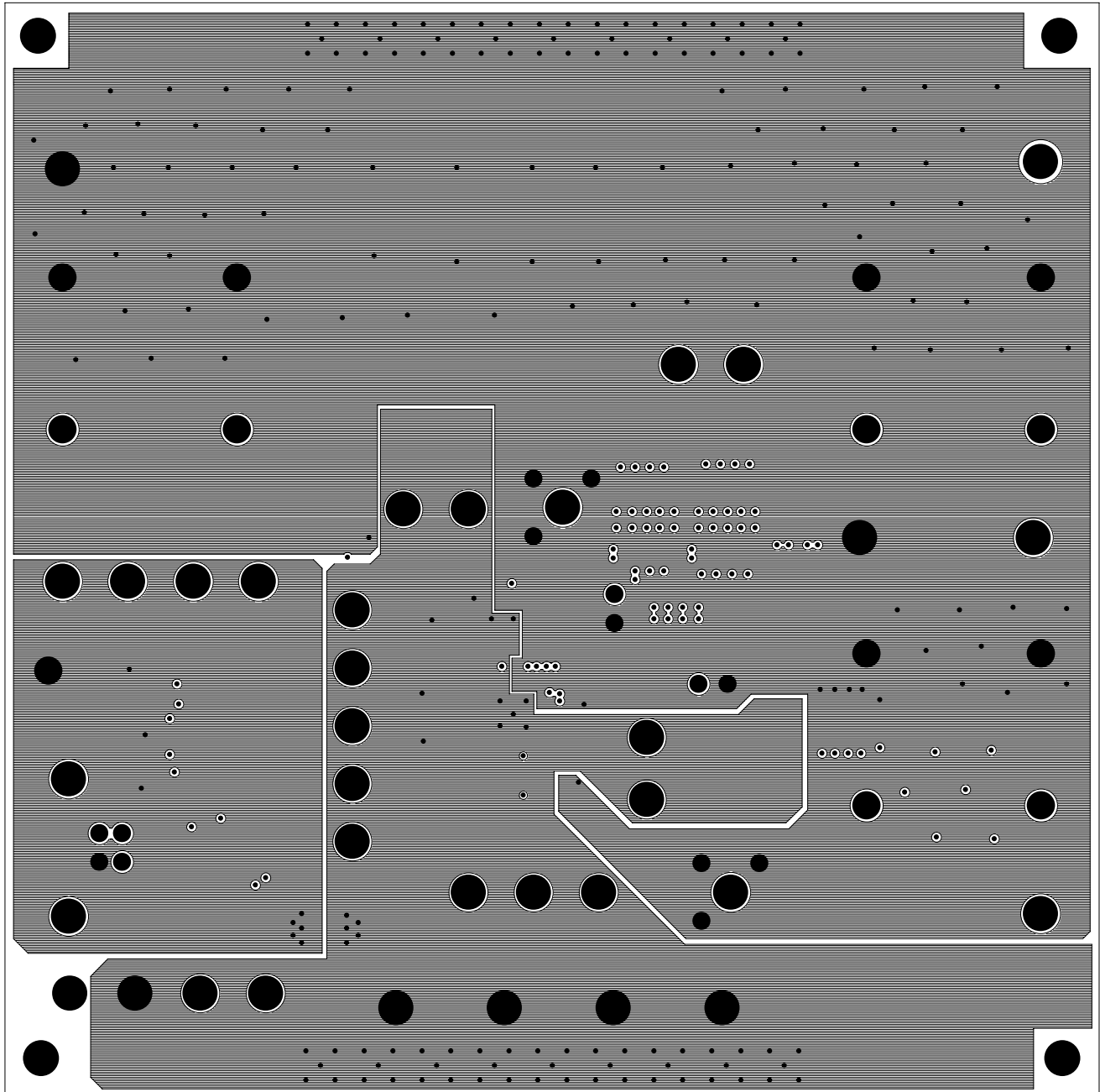

FIGURE 15. LAYER 3 (GROUNDS) (TOP VIEW)

ISL88731(C)EVAL2Z Evaluation Board Layout (Continued)

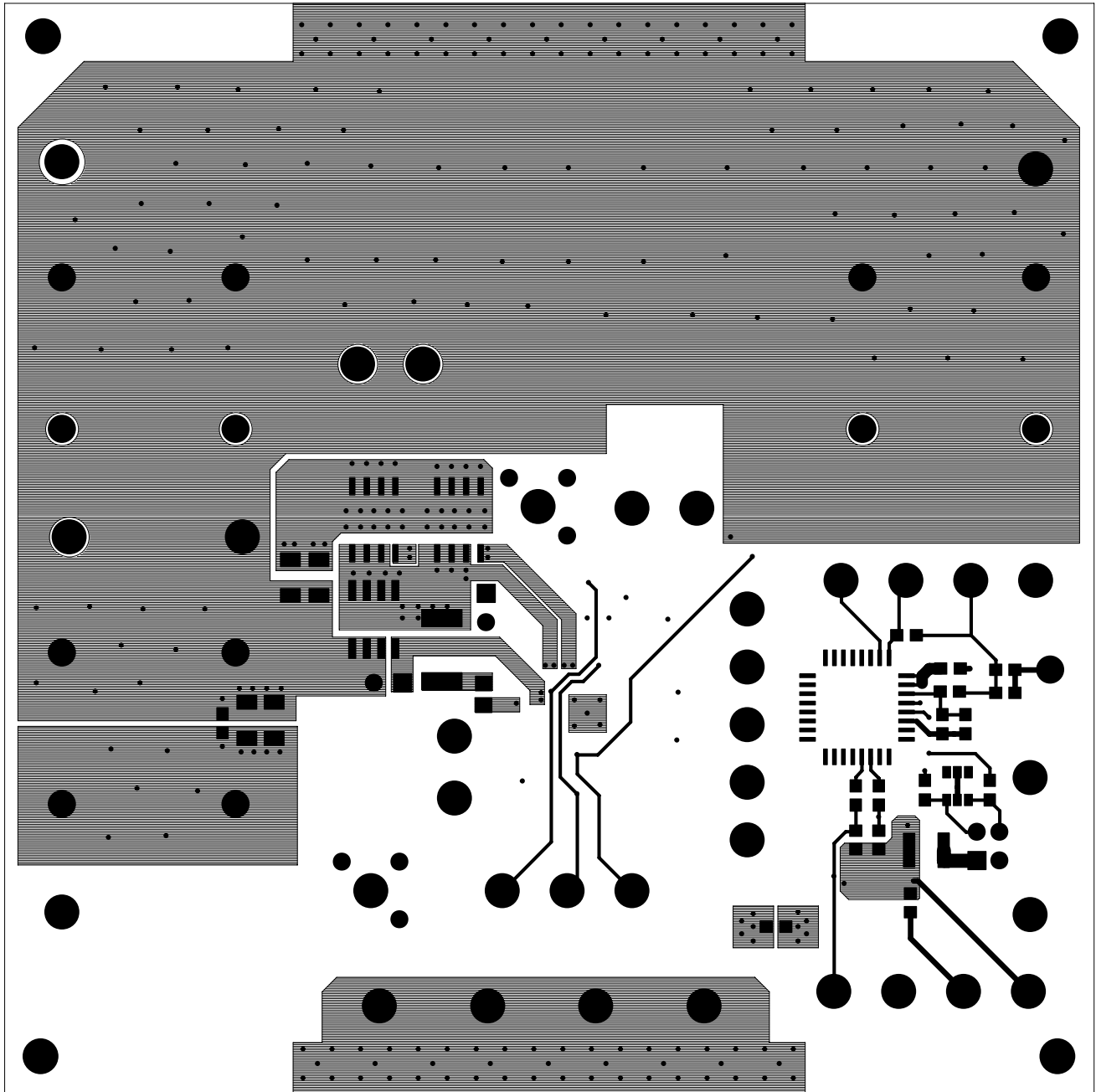

FIGURE 16. BOTTOM COPPER (BOTTOM VIEW)

