

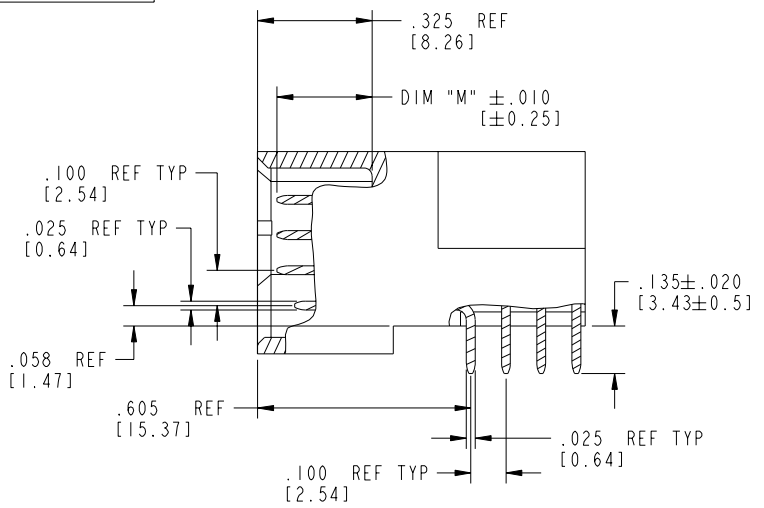

Tous droits strictement réservés. Reproduction ou communication a des tiers interdite sous quelque forme que ce soit sans autorisation écrite du propriétaire. Propriété de c FCI. Droits de reproduction FCI.

All rights strictly reserved. Reproduction or issue to third parties in any form whatever is not permitted without written authority from the proprietor. Property of FCI. Copyright FCI.

PRODUCT NUMBER  
51730-071\_\_  
NOTE: 3



BROKEN-OUT SECTION A-A  
SCALE 2:1

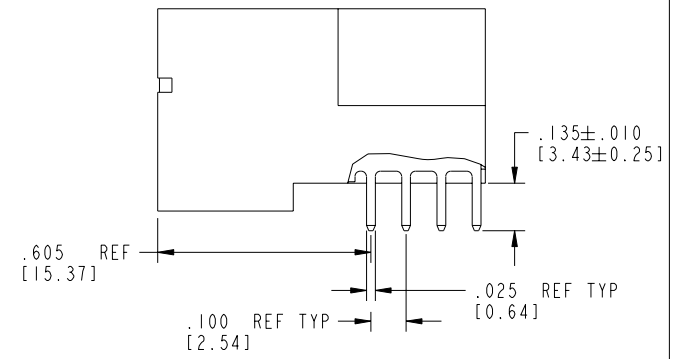

BROKEN-OUT SECTION B-B  
SCALE 2:1

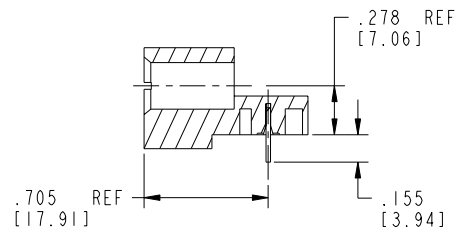

SECTION C-C

mat'l code		SEE NOTE 2		tolerances unless otherwise specified		CUSTOMER		 www.fciconnect.com	
ltr	ecn no.	dr	date	linear	.XX±.01/0.X±0.3	COPY		projection	
D					.XXX±.005/0.XX±0.13	INCH/MM		title	
				angles	.XXX±.0020/0.XX±0.051	1:1		5P + 48S + 3P	
				dr	0° ± 2°	scale		RIGHT ANGLE SOLDER HEADER	
				enr	T. BRUNGARD 02/04/03	A		product family	
				chr	M. MOSTOLLER 02/04/03	A		PwrBlade	
				appd	M. MOSTOLLER 02/04/03	A		code	
sheet index	revision sheet							213	
								sheet	
								2 of 4	

cage code 22526

Pro/E

PDM: Rev:D

STATUS: Released

Printed: Dec 20, 2010

Tous droits strictement réservés. Reproduction ou communication a des tiers interdite sous quelque forme que ce soit sans autorisation écrite du propriétaire. Propriété de c FCI. Droits de reproduction FCI.

All rights strictly reserved. Reproduction or issue to third parties in any form whatever is not permitted without written authority from the proprietor. Property of FCI. Copyright FCI.

PRODUCT NUMBER  
51730-071\_\_  
NOTE: 3

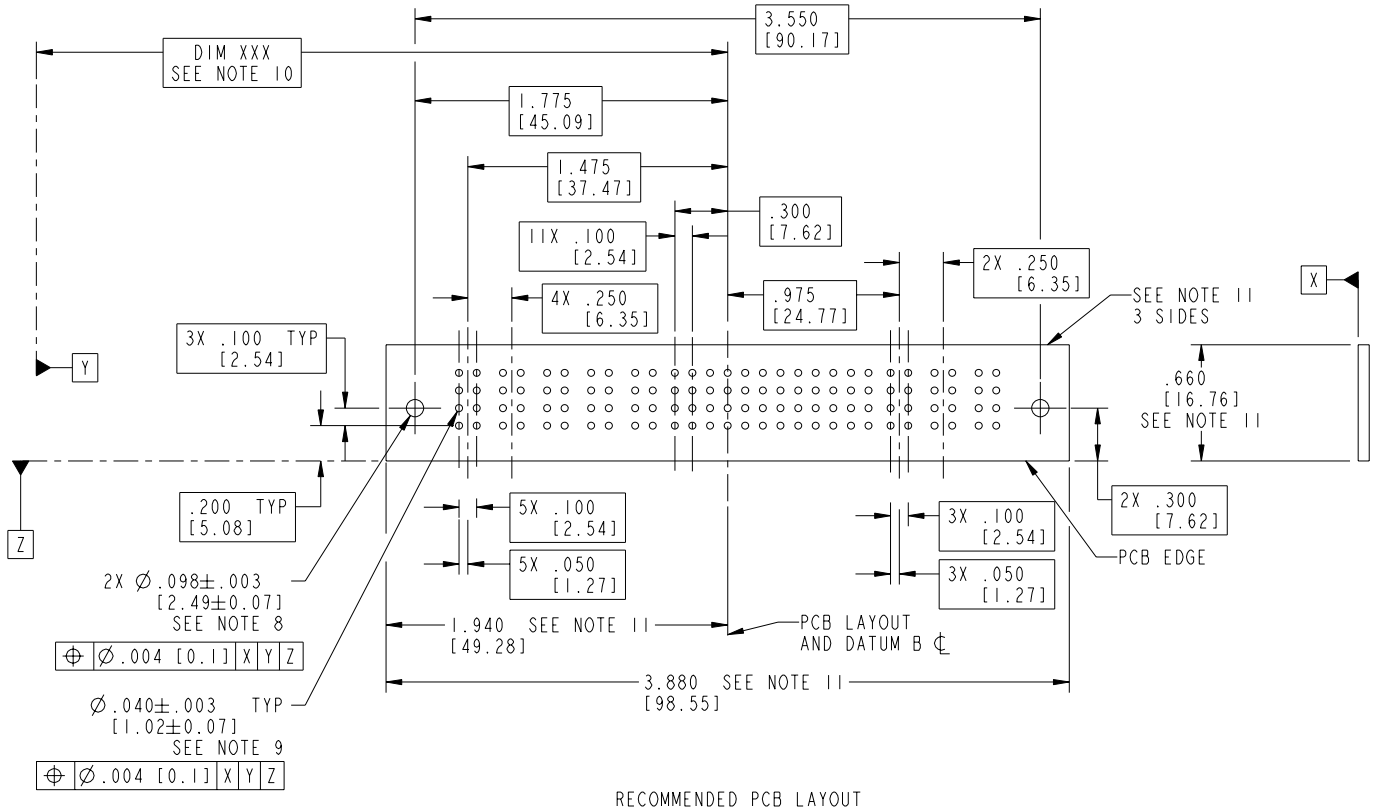

RECOMMENDED PCB LAYOUT

mat'l code				SEE NOTE 2		tolerances unless otherwise specified		CUSTOMER		 www.fciconnect.com	
ltr	ecn no.	dr	date	linear	.XX±.01/0.X±0.3	COPY		projection		title	
D					.XXX±.005/0.XX±0.13					5P + 48S + 3P	
				angles	.XXXX±.0020/0.XXX±0.051					RIGHT ANGLE SOLDER HEADER	
				dr	T. BRUNGARD 02/04/03	INCH/MM		product family		PwrBlade	
				engr	M. MOSTOLLER 02/04/03	scale		size		code	
				chr	M. MOSTOLLER 02/04/03	1:1		A		213	
				appd	M. MOSTOLLER 02/04/03			51730-071		3 of 4	
sheet index	revision sheet										

cage code 22526

Pro/E

PDM: Rev:D

STATUS: Released

Printed: Dec 20, 2010

Tous droits strictement réservés. Reproduction ou communication à des tiers interdite sous quelque forme que ce soit sans autorisation écrite du propriétaire. Propriété de c FCI. Droits de reproduction FCI.

All rights strictly reserved. Reproduction or issue to third parties in any form whatever is not permitted without written authority from the proprietor. Property of FCI. Copyright FCI.

PRODUCT NUMBER  
51730-071\_\_  
NOTE: 3

NOTES:

1. DIMENSIONS AND TOLERANCES ARE IN ACCORDANCE WITH ASME Y14.5M, 1994 UNLESS OTHERWISE SPECIFIED.

CONNECTOR NOTES:

2. HOUSING MATERIAL: UL 94 V-0 GLASS FILLED HIGH-TEMP THERMOPLASTIC  
POWER CONTACT MATERIAL: COPPER ALLOY  
SIGNAL PIN MATERIAL: COPPER ALLOY

3. PLATING:  
51730-071 Singal Pin:30u"/0.76um Au OVER 50u"/1.27um Ni ON THE CONTACT AREA.  
AND 100u"/2.54um SnPb PLATING OVER 50u"/1.27um Ni ON THE TERMINATION SECTION.  
Power Pin:30u"/0.76um Au OVER 50u"/1.27um Ni ON THE CONTACT AREA,  
AND 100u"/2.54um SnPb PLATING OVER 50u"/1.27um Ni ON THE TERMINATION SECTION.  
51730-071LF Singal Pin:30u"/0.76um Au OVER 50u"/1.27um Ni ON THE CONTACT AREA.  
AND 78u"/2.00um Sn PLATING OVER 50u"/1.27um Ni ON THE TERMINATION SECTION.  
Power Pin:30u"/0.76um Au OVER 50u"/1.27um Ni ON THE CONTACT AREA,  
AND 78u"/2.00um Sn PLATING OVER 50u"/1.27um Ni ON THE TERMINATION SECTION.

PART NUMBER 51730-071LF MEETS EUROPEAN UNION DIRECTIVE AND OTHER COUNTRY REGULATIONS AS DESCRIBED IN GS-22-008.

THE HOUSING WILL WITHSTAND EXPOSURE TO 260° PEAK TEMPERATURE FOR 10 SECONDS IN A WAVE SOLDER APPLICATION WITH A CIRCUIT BOARD.

4. MANUFACTURER'S NAME, P/N, AND DATE CODE TO APPEAR ON THIS SURFACE.

5. PRODUCT SPECIFICATION GS-12-149.  
APPLICATION SPECIFICATION BUS-20-067.

6. PACKAGED IN TRAYS.

PCB NOTES:



7. ALL HOLE DIAMETERS ARE FINISHED HOLE SIZE.

8. MOUNTING HOLES, WHERE APPLICABLE, ARE UNPLATED.

9.  $\varnothing .0453 \pm .0010$  [1.151 ± 0.025] DRILLED HOLES PLATED WITH .0003 [0.008] MIN SnPb OVER .001 [0.03] TO .003 [0.08] Cu PLATING TO ACHIEVE  $\varnothing .040 \pm .003$  [1.02 ± .07] HOLE.

10. "DIM XXX" TO BE DETERMINED BY THE CUSTOMER.

11. CONNECTOR KEEP-OUT ZONE.

mat'l code				SEE NOTE 2		tolerances unless otherwise specified		CUSTOMER		 www.fciconnect.com	
ltr	ecn no.	dr	date	linear	.XX±.01/0.X±0.3	COPY		projection		title	
D					.XXX±.005/0.XX±0.13					5P + 48S + 3P	
				angles	XXXX±.0020/0.XXX±0.051					RIGHT ANGLE SOLDER HEADER	
				dr	0° ± 2°	T. BRUNGARD 02/04/03		INCH/MM		product family	
				enrg		M. MOSTOLLER 02/04/03		1:1		PwrBlade	
				chr		M. MOSTOLLER 02/04/03		A		code	
				appd		M. MOSTOLLER 02/04/03		size		213	
sheet index		revision sheet						scale		51730-071	
								A		4 of 4	

cage code 22526 4