

Panel cut out (through hole)

Variant 1:

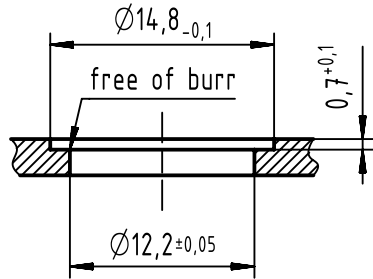

Variant 2:

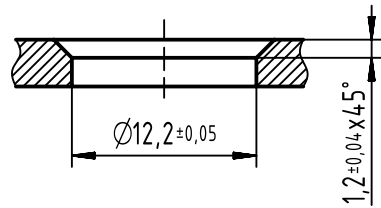

Drilling plan
plug-in side (front view)

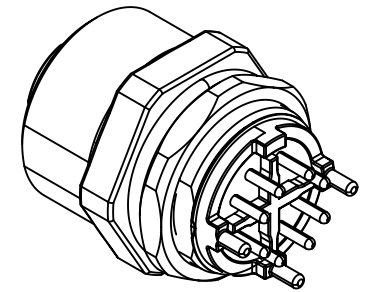
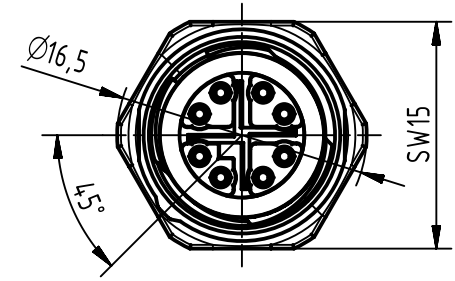
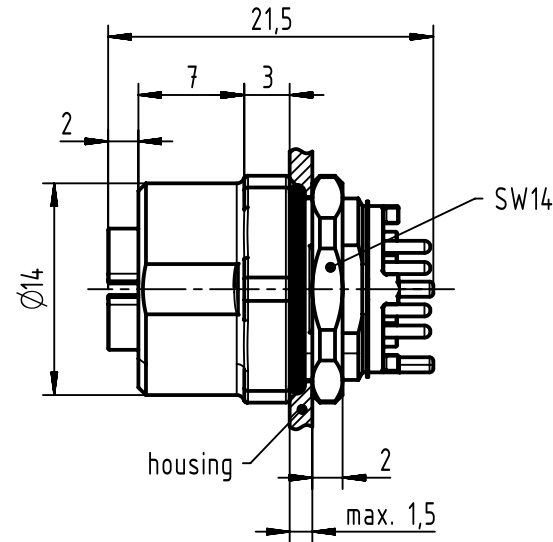
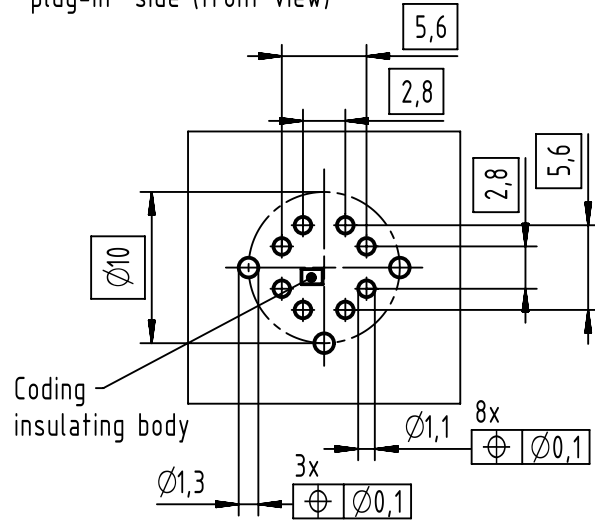

	All rights reserved Department EC PD - DE	All Dimensions in mm Original Size DIN A4		Scale 2:1	Free size tol.	Ref. Sub.
		Created by DYCKC	Inspected by WELLMANN	Standardisation HOFFMANN	Date 2013-12-02	State Final Release
HARTING Electronics GmbH D-32339 Espelkamp		Title har-speed M12 PCB-Adapter 8-pole female			Doc-Key / ECM-Nr. 100184237/UGD/001/C 500000068963	
		Type TB	Number 21033812801		Rev. C	Page 1/1