

Tous droits strictement réservés. Reproduction ou communication à des tiers interdite sous quelque forme que ce soit sans autorisation écrite du propriétaire. Propriété de c.FCI. Droits de reproduction FCI.

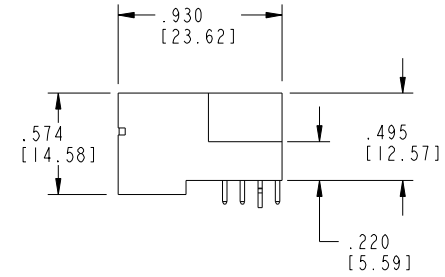

All rights strictly reserved. Reproduction or issue to third parties in any form whatever is not permitted without written authority from the proprietor. Property of FCI. Copyright FCI.

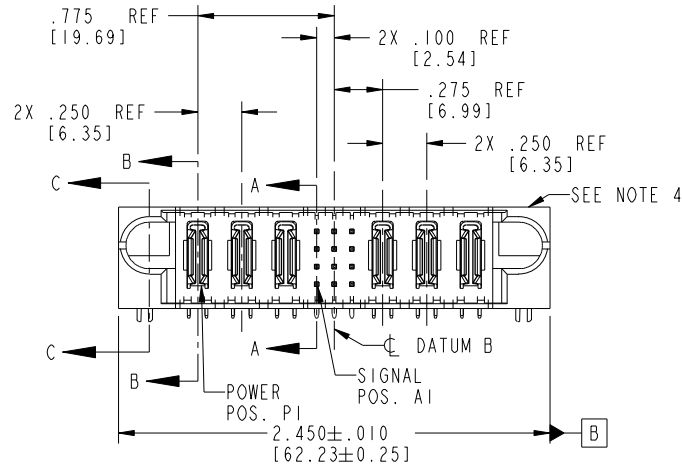
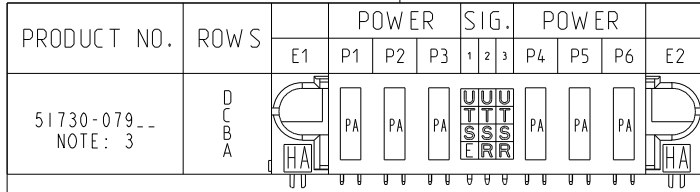

CODE	DIM "M" MATING LENGTH	CONTACT TYPE
U	.270 [6.86]	SIGNAL
T	.270 [6.86]	SIGNAL
S	.270 [6.86]	SIGNAL
R	.270 [6.86]	SIGNAL
PA	N/A [N/A]	POWER
HA	N/A [N/A]	HOLD-DOWN
E	.220 [5.59]	SIGNAL

mat'l code				SEE NOTE 2		tolerances unless otherwise specified		CUSTOMER		FCI	
ltr	ecn no.	dr	date	linear	.XX±.01/0.X±0.3	projection		COPY		www.fciconnect.com	
A	V03-0683	MEM	6/18/03	angles	.XXX±.005/0.XX±0.13	INCH/MM		title		3P + 12S + 3P	
B	DG05-0300	GuoJM	08/26/05		.XXX±.0020/0.XXX±0.051	scale		product family		PwrBlade	
C	DG05-0560	CS	12/26/05		0°±2°	1:1		size		213	
D	DG08-0253	SH	09/13/08	dr				dwg no		51730-079	
				enr	M. MOSTOLLER 6/18/03			sheet		1 of 4	
				chr	H. BREWBAKER 6/18/03			cage code		22526	
				appd	M. MOSTOLLER 6/18/03						
sheet index	revision sheet	D	D	D	D						
		1	2	3	4						

Pro/E

cage code 22526

Tous droits strictement réservés. Reproduction ou communication à des tiers interdite sous quelque forme que ce soit sans autorisation écrite du propriétaire. Propriété de c.FCI. Droits de reproduction FCI.

All rights strictly reserved. Reproduction or issue to third parties in any form whatever is not permitted without written authority from the proprietor. Property of FCI. Copyright FCI.

PRODUCT NUMBER
51730-079__
NOTE: 3

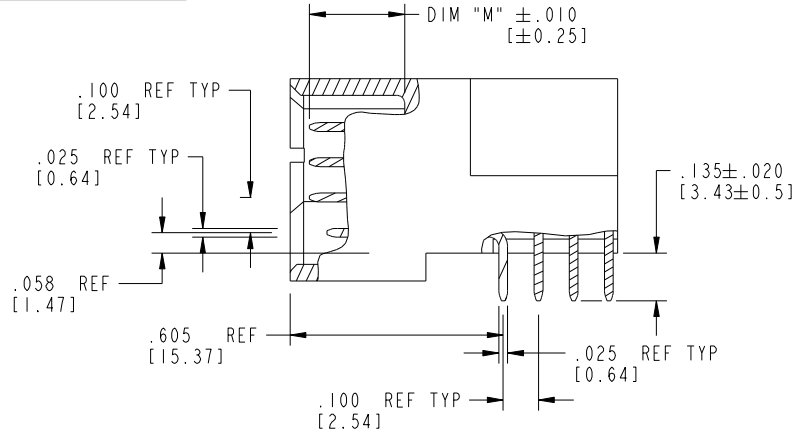

BROKEN-OUT SECTION A-A
SCALE 2:1

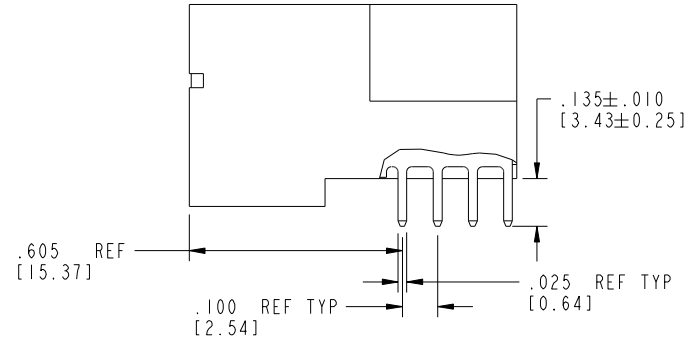

BROKEN-OUT SECTION B-B
SCALE 2:1

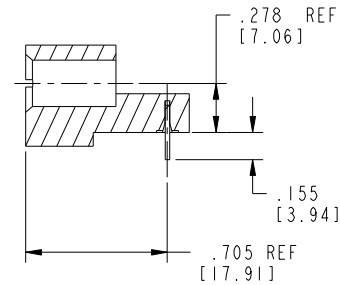

SECTION C-C

mat'l code		SEE NOTE 2		tolerances unless otherwise specified		CUSTOMER		FCI		www.fciconnect.com	
ltr	ecn no.	dr	date	linear	.XX±.01/0.X±0.3	COPY		title 3P + 12S + 3P			
D					.XXX±.005/0.XX±0.13	projection		RIGHT ANGLE SOLDER HEADER			
				angles	.XXX±.0020/0.XXX±0.051	INCH/MM		product family PwrBlade		code 213	
				dr	0°±2°	scale		size dwg no		sheet 2 of 4	
				enrg	M. MOSTOLLER 6/18/03	1:1		A 51730-079			
				chr	M. MOSTOLLER 6/18/03						
				appd	H. BREWBAKER 6/18/03						
sheet index		revision sheet									

cage code 22526

Pro/E

Tous droits strictement réservés. Reproduction ou communication à des tiers interdite sous quelque forme que ce soit sans autorisation écrite du propriétaire. Propriété de c.FCI. Droits de reproduction FCI.



All rights strictly reserved. Reproduction or issue to third parties in any form whatever is not permitted without written authority from the proprietor. Property of FCI. Copyright FCI.

PRODUCT NUMBER
51730-079__
NOTE: 3

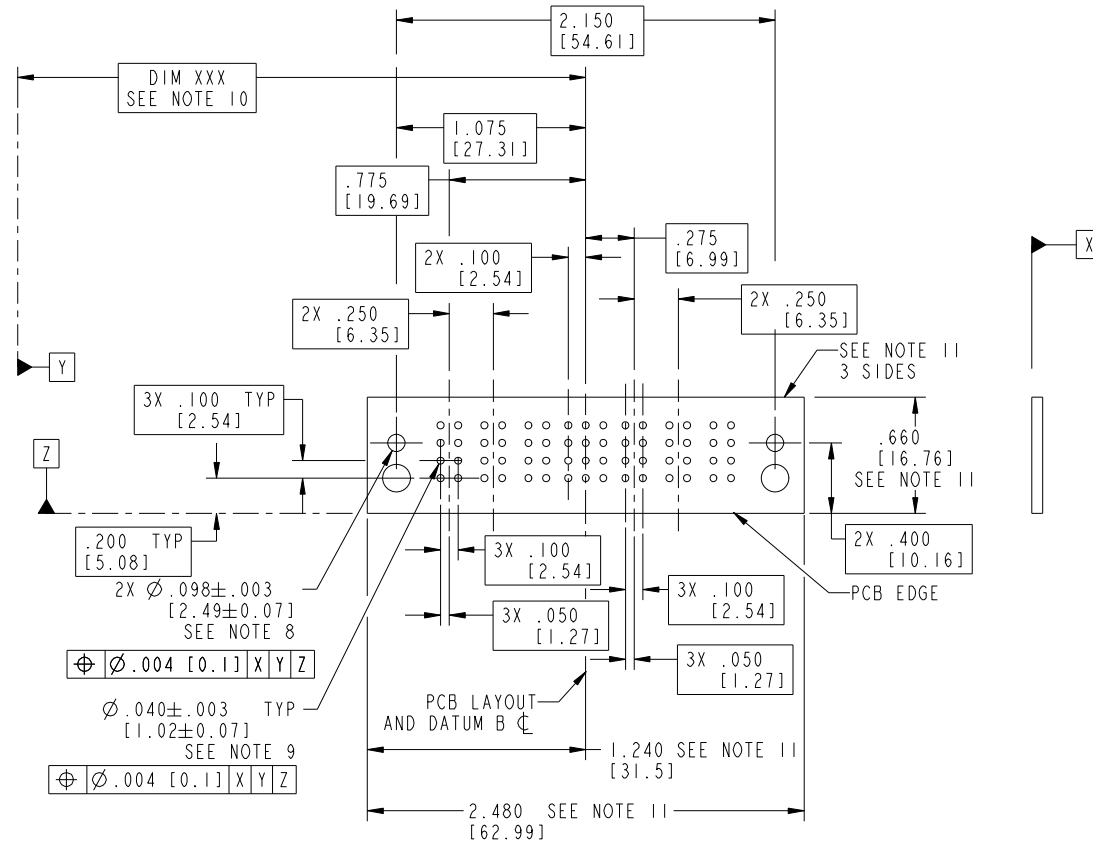

RECOMMENDED PCB LAYOUT

mat'l code		SEE NOTE 2		tolerances unless otherwise specified		CUSTOMER		 www.fciconnect.com	
ltr	ecn no.	dr	date	linear	.XX±.01/0.X±0.3	COPY		title	
D					.XXX±.005/0.XX±0.13	projection		3P + 12S + 3P	
				angles	.XXX±.0020/0.XXX±0.051			RIGHT ANGLE SOLDER HEADER	
				dr	0°±?	INCH/MM		product family	
				engr	M. MOSTOLLER 6/18/03	scale		PwrBlade	
				chr	M. MOSTOLLER 6/18/03	1:1		code	
				appd	H. BREWBAKER 6/18/03	A		213	
					M. MOSTOLLER 6/18/03	51730-079		sheet	
sheet index	revision sheet							3 of 4	

cage code 22526

Pro/E

Tous droits strictement reserves. Reproduction ou communication a des tiers interdite sous quelque forme que ce soit sans autorisation écrite du propriétaire. Propriete de c FCI. Droits de reproduction FCI.



All rights strictly reserved. Reproduction or issue to third parties in any form whatever is not permitted without written authority from the proprietor. Property of FCI. Copyright FCI.

PRODUCT NUMBER
51730-079__
NOTE: 3

NOTES:

1. DIMENSIONS AND TOLERANCES ARE IN ACCORDANCE WITH ASME Y14.5M, 1994 UNLESS OTHERWISE SPECIFIED.

CONNECTOR NOTES:

- 2. HOUSING MATERIAL: UL 94 V-0 GLASS FILLED HIGH-TEMP THERMOPLASTIC
POWER CONTACT MATERIAL: COPPER ALLOY
SIGNAL PIN MATERIAL: COPPER ALLOY
 - 3. PLATING:
▲ SEE ITEM 1 & 2 IN PRINT 10064183 FOR PLATING SPEC OF 51730-079 AND 51730-079LF RESPECTIVELY
 - 4. MANUFACTURER'S NAME, P/N, AND DATE CODE TO APPEAR ON THIS SURFACE.
 - 5. PRODUCT SPECIFICATION GS-12-149.
APPLICATION SPECIFICATION BUS-20-067.
 - 6. PACKAGED IN TRAYS.
- PCB NOTES:
- 7. ALL HOLE DIAMETERS ARE FINISHED HOLE SIZE.
 - 8. MOUNTING HOLES, WHERE APPLICABLE, ARE UNPLATED.
 - 9. $\varnothing .0453 \pm .0010$ [1.151 \pm 0.025] DRILLED HOLES PLATED WITH .0003 [0.008] MIN SnPb OVER .001 [0.03] TO .003 [0.08] Cu PLATING TO ACHIEVE $\varnothing .040 \pm .003$ [1.02 \pm .07] HOLE.
 - 10. "DIM XXX" TO BE DETERMINED BY THE CUSTOMER.
 - 11. CONNECTOR KEEP-OUT ZONE.

12: ▲ SYMBOL WILL BE NEXT TO ANY DIMENSION, VIEW, OR NOTE WHICH HAS BEEN MODIFIED WITH CURRENT DRAWING VERSION.

mat'l code		SEE NOTE 2		tolerances unless otherwise specified		CUSTOMER		FCI		www.ficconnect.com	
ltr	ecn no.	dr	date	linear	.XX±.01/0.X±0.3	COPY					
D					.XXX±.005/0.XX±0.13	projection		title 3P + 12S + 3P			
				angles	.XXX±.0020/0.XXX±0.051			RIGHT ANGLE SOLDER HEADER			
				dr	0°±?	INCH/MM		product family PwrBlade		code 213	
				enrg	M. MOSTOLLER 6/18/03	scale		size dwg no		sheet 213	
				chr	M. MOSTOLLER 6/18/03	1:1		A 51730-079		4 of 4	
				appd	M. MOSTOLLER 6/18/03						
sheet index	revision sheet										

cage code 22526