

RECOMMENDED  
PANEL MOUNTING

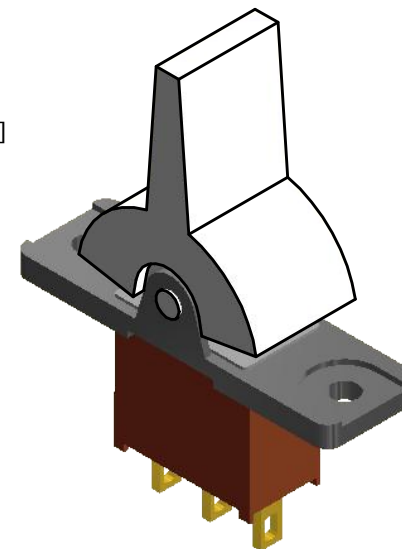

SWITCH FUNCTION		
POS. 1	POS. 2	POS. 3
(ON)	OFF	(ON)
2-3	OPEN	2-1

(ON) = MOMENTARY

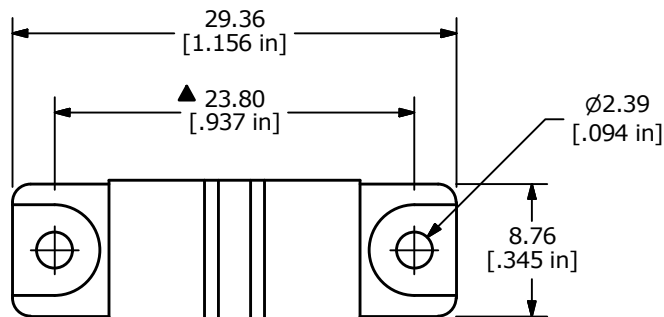
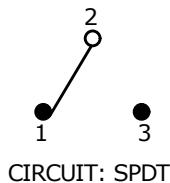

▲ ACTUATOR COLOR:  
WHITE

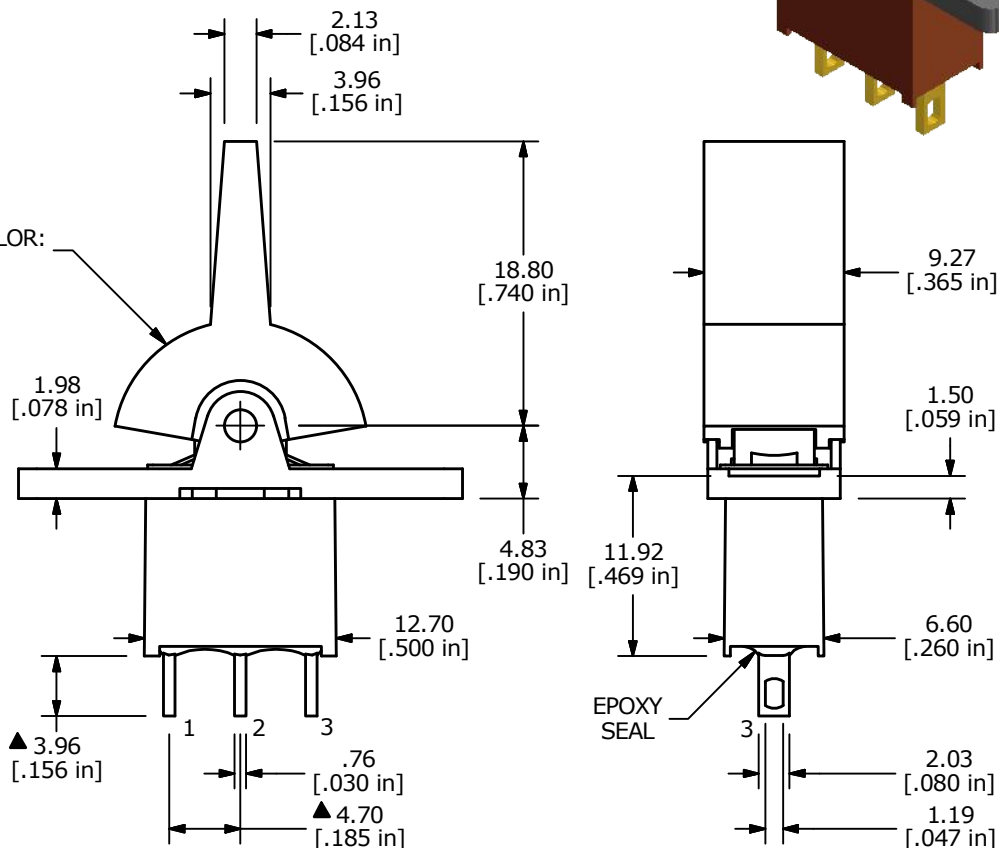

NOTE:

1. ALL DIMENSIONS IN MM [INCH]
2. GENERAL TOLERANCE: X.X=±0.4  
X.XX=±0.25
3. TERMINAL NUMBERS FOR REF ONLY
- ▲ 4. PLATING MATERIAL: SILVER
5. RATING: 5A @120VAC or 28VDC  
2A @250VAC
6. ELECTRIC LIFE: 30,000 MAKE-AND-BREAK CYCLES  
AT FULL LOAD.
7. INSULATION RESISTANCE: 1,000 MEGA-OHM MIN.
8. DIELECTRIC STRENGTH: 1,000 V RMS @SEA LEVEL.
9. OPERATING TEMP.: -30°C to 85°C
10. ▲ DENOTES CRITICAL PARAMETER.
11. 2011/65/EU (ROHS) COMPLIANT



C	22709	UPDATED SWITCH FUNCTION CHART	2/20/17	MJR
B	22704	UPDATED LAYOUT AND TERMINALS	2/8/17	MJR
REV	PCR NO	DESCRIPTION	DATE	BY

TITLE 300AWSP4R2WHTM1QE				
SCALE 2:1	DATE 8/11/2003	DR AR	DWG T301417	REV C

THE INFORMATION CONTAINED IN THIS DOCUMENT IS PROPRIETARY TO E-SWITCH AND IS NOT TO BE COPIED OR TRANSFERRED