

The SRM1's high-speed distributed I/O controller is a revolutionary design in PLC control. The SRM1 places all the processing power and control in the ultra compact master unit and allows you to distribute up to 256 points of I/O via a twisted pair network. You can create a distributed I/O network with up to 32 nodes at distances up to 500 meters away. This allows for reduced cabling costs, increased flexibility, lower system costs, and optimum efficiency when I/O has to be located away from the CPU.



- Distributed I/O system supports up to 256 I/O points
- SRM1 master communicates with up to 32 nodes at up to 500 meters away
- Twisted pair network allows easy addition of devices and reduces cabling costs
- High-speed communications at up to 750 kbps
- Multiple remote I/O options including discrete and analog I/O devices
- 4k Program memory; 2 k Data memory
- UL/CSA/CE approvals



### Basic Configuration

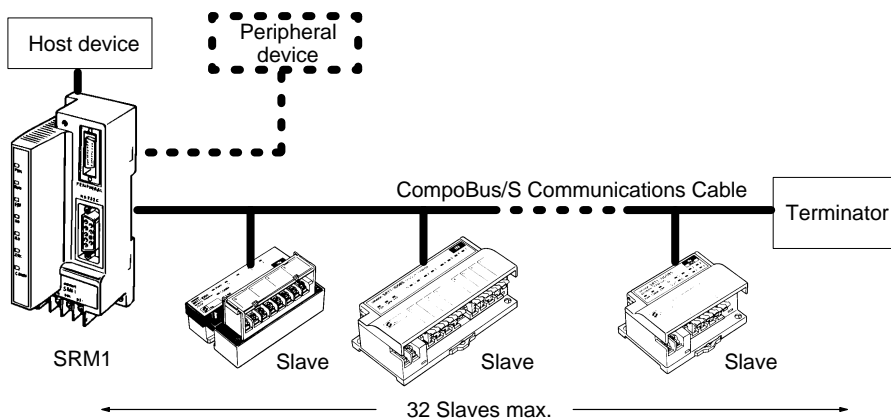

# Ordering Information

## ■ CPU/MASTER UNITS

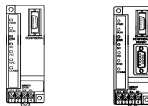
Product	Appearance	Power supply	Peripheral port	Serial port	Standards	Part number
CPU/Master Unit		DC	Yes	—	UL, CSA, CE (See Note 2.)	<b>SRM1-C01-V2</b>
		DC	Yes	RS-232C port		<b>SRM1-C02-V2</b>

## ■ COMPOBUS/S I/O SLAVE TERMINALS

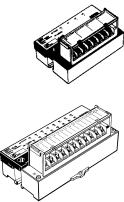
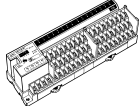
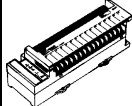
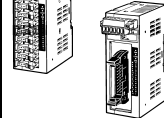
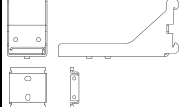
Product	Appearance	Specifications	Power supply (See Note 1.)	Standards (See Note 2.)	Part number
Transistor remote I/O terminal blocks  SRT2 models support long distance and high-speed communications		4 transistor input (NPN) 4 transistor inputs (PNP) 8 transistor inputs (NPN) 8 transistor inputs (PNP) 16 transistor inputs (NPN) 16 transistor inputs (PNP)	Multiple	UL, CSA, CE	<b>SRT2-ID04</b> <b>SRT2-ID04-1</b> <b>SRT2-ID08</b> <b>SRT2-ID08-1</b> <b>SRT2-ID16</b> <b>SRT2-ID16-1</b>
		4 transistor outputs (NPN) 4 transistor outputs (PNP) 8 transistor outputs (NPN) 8 transistor outputs (PNP) 16 transistor outputs (NPN) 16 transistor outputs (PNP)			<b>SRT2-OD04</b> <b>SRT2-OD04-1</b> <b>SRT2-OD08</b> <b>SRT2-OD08-1</b> <b>SRT2-OD16</b> <b>SRT2-OD16-1</b>
Transistor remote I/O terminal blocks with individual commons for each point		16 transistor inputs (NPN) 16 transistor inputs (PNP) 16 transistor I/O points (NPN) 16 transistor I/O points (PNP) 16 transistor outputs (NPN) 16 transistor outputs (PNP)	Multiple	UL, CSA, CE	<b>SRT2-ID16T</b> <b>SRT2-ID16T-1</b> <b>SRT2-MD16T</b> <b>SRT2-MD16T-1</b> <b>SRT2-OD16T</b> <b>SRT2-OD16T-1</b>
Plug-in relay output blocks		8 relay outputs 16 relay outputs 8 power MOSFET relay outputs 16 power MOSFET relay outputs	Local	UL, CSA, CE	<b>SRT2-ROC08</b> <b>SRT2-ROC16</b> <b>SRT2-ROF08</b> <b>SRT2-ROF16</b>
		Electromechanical relay Power MOSFET relay	—		<b>G6D-1A DC24</b> <b>G3DZ-2R6PL DC24</b>
Connector remote terminal blocks  (MIL connector on 16-pt models or sensor connector on 8-pt models)		8 transistor input (NPN) 8 transistor inputs (PNP) 8 transistor outputs (NPN) 8 transistor outputs (PNP)	Multiple	UL, CSA, CE	<b>SRT2-VID08S</b> <b>SRT2-VID08S-1</b> <b>SRT2-VOD08S</b> <b>SRT2-VOD08S-1</b>
		16 transistor inputs (NPN) 16 transistor inputs (PNP) 16 transistor outputs (NPN) 16 transistor outputs (PNP)			<b>SRT2-VID16ML</b> <b>SRT2-VID16ML-1</b> <b>SRT2-VOD16ML</b> <b>SRT2-VOD16ML-1</b>
Connector remote terminal blocks  (MIL connector on 16-pt models or sensor connector on 8-pt models)		Mounting bracket, side-mounting Mounting bracket, surface mount Input cable to G7TC block, 0.5 m Output cable to G7TC block, 0.5 m	—	UL, CSA, CE	<b>SRT2-ATT01</b> <b>SRT2-ATT02</b> <b>G79-I50C</b> <b>G79-O50C</b>







(This table continues on the next page.)

Note: 1. Information on EC Directives

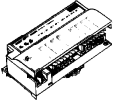
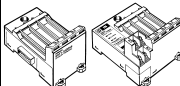
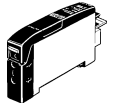
Individual OMRON products that comply with EC Directives conform to the common emission standards of EMC Directives. However, the emission characteristics of these products installed on customers' equipment may vary depending on the configuration, wiring, layout, and other conditions of the control panel used. For this reason, customers are requested to check whether the emission characteristics of the entire machine or equipment comply with the EMC Directives.

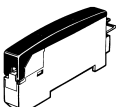
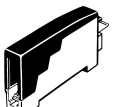
2. Network power supply: One power supply can be used for communications and I/O over flat cable SCA1-4F10.  
Multiple power supply: Use separate power supplies for communications and I/O. Flat cable cannot be used for I/O power.  
Local power supply: Power can only be provided from a single source using twisted-pair cable.

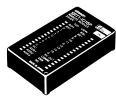
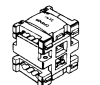
CompoBus/S I/O Slave Terminals Table – continued from previous page

Product	Appearance	Specifications	Power supply (See Note 1.)	Standards (See Note 2.)	Part number
Sensor remote terminal block		8 inputs (NPN) 8 outputs	Multiple	UL, CSA, CE	SRT1-ID08S SRT1-OD08S
Sensor connectors		4 automatic teaching points (NPN)	Network		SRT1-ND08S
Sensor amplifier remote terminal blocks for CompoBus/S		4 single-point fiber-optic amplifiers 1 four-point fiber-optic amplifier 4 single-point amp, expansion 1 four-point amp, expansion	Local	CE	SRT1-TID04S SRT1-TKD04S SRT1-XID04S SRT1-XKD04S
Fiber-optic sensor amplifiers for Omron's E32-series fiber-optic cables		High accuracy, long-distance, 1-ch General-purpose, 1 channel Multi-functional, 1 channel	—	—	E3X-NH16 E3X-NT16 E3X-NT26
		Multi-functional, 4 channels	—	—	E3X-NM16
Inductive proximity sensor amplifier		Sensor detects all metal targets, offer 1 teach function, 1 channel; use E2C sensing heads	—	—	E2C-T16
Terminal block		Connect any 2-wire or 3-wire DC photoelectric or proximity sensor, limit switch or basic switch; 1 channel	—	—	E39-JID01
Analog input terminal		1 to 4 inputs (set with DIP switch) Six ranges from -10 to +10 V and 0 to 20 mA	Network	CE	SRT2-AD04
Analog output terminal		1 to 2 outputs (set with DIP switch) Five ranges from -10 to +10 V and 4 to 20 mA	Network		SRT2-DA02
PC board remote I/O modules		16 point input, NPN 16 point output, NPN Standard DIP pitch	Local	CE	SRT1-ID16P SRT1-OD16P
Branch connector Extension connector Connector terminator		—	—	—	SCN1-TH4 SCN1-TH4E SCN1-TH4T
Flat cable		100 m	—	—	SCA1-4F10
Twisted pair cable		—			Belden #9409 cable (available commercially)
Terminal-block terminator		—	—	—	SRS1-T

## Note: 1. Information on EC Directives

Individual OMRON products that comply with EC Directives conform to the common emission standards of EMC Directives. However, the emission characteristics of these products installed on customers' equipment may vary depending on the configuration, wiring, layout, and other conditions of the control panel used. For this reason, customers are requested to check whether the emission characteristics of the entire machine or equipment comply with the EMC Directives.

2. Network power supply: One power supply can be used for communications and I/O over flat cable SCA1-4F10.  
Multiple power supply: Use separate power supplies for communications and I/O. Flat cable cannot be used for I/O power.  
Local power supply: Power can only be provided from a single source using twisted-pair cable.

## ■ I/O LINK UNITS

CPU	Description	Part number
CPM1A/CPM2A	Allows CPM1A/CPM2A to be used as a terminal on a CompoBus/S network (8 inputs/8 outputs)	CPM1A-SRT21
CPM2C	Allows CPM2C to be used as a terminal on a CompoBus/S network (8 inputs/8 outputs)	CPM2C-SRT21

## ■ ADAPTERS

Product	Description	Part number
RS-232C adapter	Converts peripheral port to RS-232C level; cable length 3.3 m	CQM1-CIF02
	Converts peripheral port to RS-232C level; DIN mount	CPM1-CIF01
RS-422/RS-485 adapter	Converts peripheral port to RS-422/RS-485; DIN mount	CPM1-CIF11

## ■ CONNECTING CABLES

Product	Description	Part number
RS-232C cable	RS-232C to RS-232C for PLC communication; cable length 2 m	C200H-CN320-EU
	RS-232C to RS-232C; PC connection for program download; cable length 2 m	C200HS-CN220-EU

## ■ PERIPHERAL DEVICES

Product	Description	Part number
Programming console	Hand-held programming console with cable attached, 2 m length	CQM1-PRO01-E
	Hand-held programming console with back light (cable not included)	C200H-PRO27-E
Connecting cable	Connects C200H programming console to peripheral port, 2 m length	C200H-CN222
	Connects C200H programming console to peripheral port, 4 m length	C200H-CN422

## ■ SUPPORT SOFTWARE

Product	Functions	Part number
CX-Programmer Jr.	Windows-based programming software; reduced instruction set and networking commands. OS: Windows 95/98/NT	WS02-CXPC1-EJR-V2.0
CX-Programmer	Full programming software package programs micro, small and larger controllers.	WS02-CXPC1-EV2.0

## ■ PROGRAM TRANSFER EQUIPMENT

Product	Description	Part number
Expansion Memory Unit	Uploads and downloads program and setup memory areas to and from the controller.	CPM1-EMU01-V1
EEPROM (256 kbits)	Used with the Expansion Memory Unit.	CPM1-EEPROM-EMU01

## ■ MANUALS

Product	Description	Part number
Operation manual	CompoBus/S SRM1 Master operation manual	W318
Operation manual	CompoBus/S SRT2-Series terminals operation manual	W266
Programming manual	SRM1/CPM1A/CPM2A/CPM2C programming manual	W353

# Nomenclature

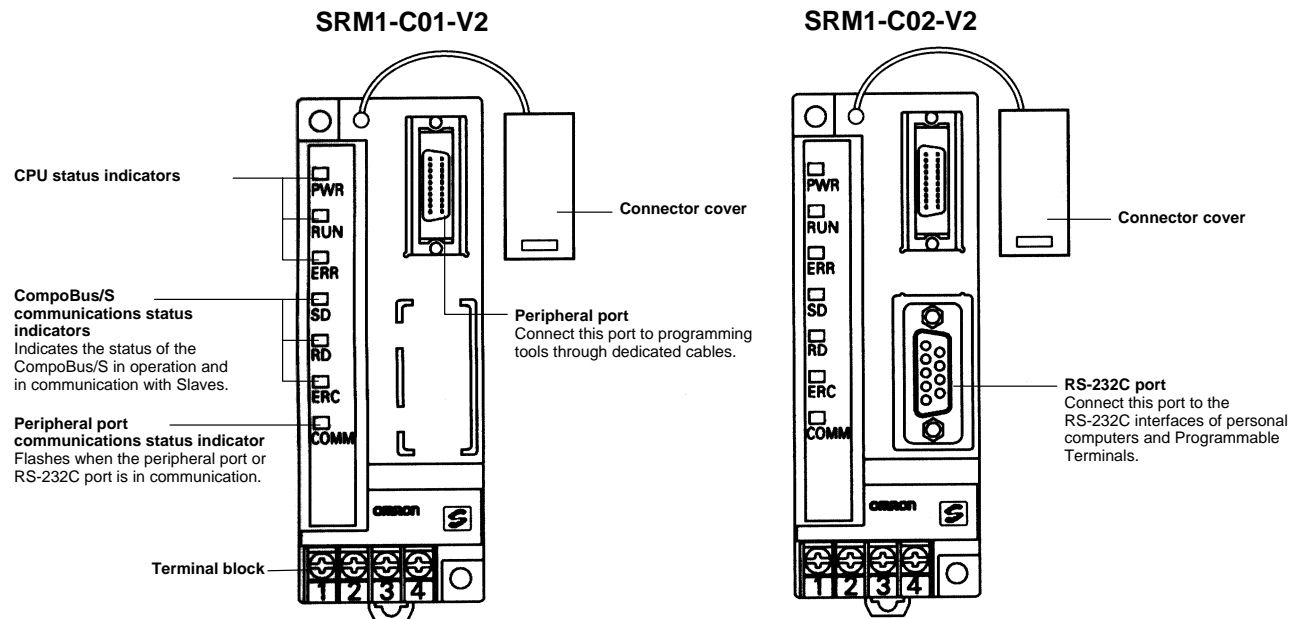

# Specifications

## ■ GENERAL SPECIFICATIONS

Supply voltage	24 VDC (20.4 to 26.4 VDC allowable)
Power consumption	3.5 W max.
Inrush current	5.0 A max. (pulse width: 15 ms max.)
Noise immunity	Conforms to IEC61000-4-4; 2 kV (power lines)
Vibration resistance	10 to 57 Hz, 0.075-mm amplitude, 57 to 150 Hz, acceleration: 9.8 m/s <sup>2</sup> in X, Y, and Z directions for 80 minutes each (Time coefficient; 8 minutes × coefficient factor 10 = total time 80 minutes)
Shock resistance	147 m/s <sup>2</sup> three times each in X, Y, and Z directions
Ambient temperature	Operating: 0°C to 55°C (32°F to 131°F) Storage: -20°C to 75°C (-4°F to 167°F)
Humidity	10% to 90% RH with no condensation
Atmosphere	Must be free from corrosive gas.
Power interrupt time	DC type: 2 ms min.
Weight	150 g max.

## ■ PERFORMANCE SPECIFICATIONS

Programming language	Ladder diagram
Instruction length	1 step per instruction, 1 to 5 words per instruction
Types of instructions	Basic instructions: 14 Special instructions: 81 instructions, 125 variations
Execution time	Basic instructions: 0.97 μs (LD instruction) Special instructions: 9.1 μs (MOV instruction)
Program capacity	4,096 words
User data memory capacity	2,022 words
Memory backup	Flash memory (no backup needed): User programs Battery: Data memory, 10 years at 25°C
Peripheral port	One port: Host Link, No Protocol
RS-232C port	One port (SRM1-C02-V2): Host Link, NT Link, 1:1 Link, No Protocol

## ■ I/O ALLOCATION

Maximum I/O points	256 points
Input bits	160 bits: 00000 to 00915 (Bits not used as input bits can be used as work bits.)
Output bits	160 bits: 01000 to 01915 (Bits not used as output bits can be used as work bits.)
Work bits	704 bits: 00800 to 00915 (Words IR 008 and IR 009) 01800 to 01915 (Words IR 018 and IR 019) 20000 to 23915 (Words IR 200 to IR239)
Special bits (SR area)	248 bits: 24000 to 25507 (Words IR 240 to IR 255)
Temporary bits (TR area)	8 bits (TR0 to TR7)
Holding bits (HR area)	320 bits: HR 0000 to HR 1915 (Words HR 00 to HR 19)
Auxiliary bits (AR area)	256 bits: AR 0000 to AR 1515 (Words AR 00 to AR 15)
Link bits (LR area)	256 bits: LR 0000 to LR 1515 (Words LR 00 to LR 15)
Timers/Counters	128 timers/counters (TIM/CNT 000 to TIM/CNT 127)  100-ms timers: TIM 000 to TIM 127 10-ms timers (high-speed counter): TIM 000 to TIM 003 Decrementing counters and reversible counters  (Note: A malfunction may occur if the cycle time is over 10 ms when TIM 004 to TIM 127 are used with the TIMH instruction.)
Data memory	Read/Write: 2,022 words (DM 0000 to DM 2022) Read-only: 512 words (DM 6144 to DM 6655)
Interval timer interrupts	One-shot mode / Scheduled interrupt mode, one bit (0.5 to 319.968 ms)

The input bits of SRM1 words 000 to 007, and the output bits of words 010 to 017, are allocated to the CompoBus/S Slave. These allocations are shown in the following table:

IN0 to IN15 are Input Slave node numbers, and OUT0 to OUT15 are Output Slave node numbers.

If the maximum number of CompoBus/S devices is set to 16, then IN8 to IN15 and OUT8 to OUT15 can be used as work bits.

For CompoBus/S Slaves with fewer than eight points, the bit addresses from either bit 0 or bit 8 are allocated as reserved.

I/O	Word address	Slave node	
		Bits 15 to 8	Bits 7 to 0
Inputs	000	IN1	IN0
	001	IN3	IN2
	002	IN5	IN4
	003	IN7	IN6
	004	IN9	IN8
	005	IN11	IN10
	006	IN13	IN12
	007	IN15	IN14

I/O	Word address	Slave node	
		Bits 15 to 8	Bits 7 to 0
Outputs	010	OUT1	OUT0
	011	OUT3	OUT2
	012	OUT5	OUT4
	013	OUT7	OUT6
	014	OUT9	OUT8
	015	OUT11	OUT10
	016	OUT13	OUT12
	017	OUT15	OUT14

## ■ COMPOBUS/S COMMUNICATIONS SPECIFICATIONS

Communications method		CompoBus/S protocol
Coding method		Manchester coding method
Connection method		Multi-drop method and T-branch method (See Note 1.)
Communications baud rate (See Note 2.)	High-speed mode	750 kbps
	Long-distance mode	93.75 kbps
Communications cycle time	High-speed mode	0.8 ms, when maximum number of connectible terminals is 32
		0.5 ms, when maximum number of connectible terminals is 16
	Long-distance mode	6.0 ms, when maximum number of connectible terminals is 32
		4.0 ms, when maximum number of connectible terminals is 16
Maximum number of connectible terminals		32: 16 IN and 16 OUT 16: 8 IN and 8 OUT
Communications distance	High-speed mode	Belden #9409 or VCTF cable: Main line length: 100 m max. Branch-line length: 3 m max. Total length of branches: 50 m max.  Flat cable (SCA1-4F10): Main line length: 30 m max. Branch-line length: 3 m max. Total length of branches: 30 m max. (When flat cable is used to connect fewer than 16 Slaves, the main line can be up to 100 m long and total branch line length can be up to 50 m.)
	Long-distance mode	Belden #9409 or VCTF cable: Main line length: 500 m max. Branch-line length: 6 m max. Total length of branches: 120 m max.
Cable	Vinyl-clad VCTF JIS C3306	Two 0.75 mm <sup>2</sup> conductors (2 signal wires)
	Flat cable	Four 0.75 mm <sup>2</sup> conductors (2 signal wires and 2 power supply wires)
Number of points per CPU		256 (128 IN and 128 OUT), when maximum number of connectible terminals is 32. 128 (64 IN and 64 OUT), when maximum number of connectible terminals is 16.
Error control checks		Manchester code check, frame length check, parity check, two-transfer comparison

- Note: 1. A terminator must be connected to the point in the system farthest from the Master.  
2. The communications baud rate is switched using DM settings (default setting is 750 kbps).

## ■ TERMINATORS

### Ratings/Characteristics

Rated current	4 A
Contact resistance	20 mΩ max.
Insulation resistance	1,000 MΩ min. at 500 VDC
Withstand voltage	1,000 VAC for 1 min, leakage current: 1 mA max.
Cable pulling strength	50 N (5.1 kgf) min.
Operating temperature	-20°C to 70°C (-4°F to 158°F)

### Materials

Housing	PA66 resin (UL94V-2)
Cover	Branching and extension: Gray Terminator: Black
Contact	Phosphor bronze and nickel base, tin plated

# Dimensions

Unit: mm (inch)

## ■ CPU/MASTER UNITS

SRM1-C01-V2, SRM1-C02-V2

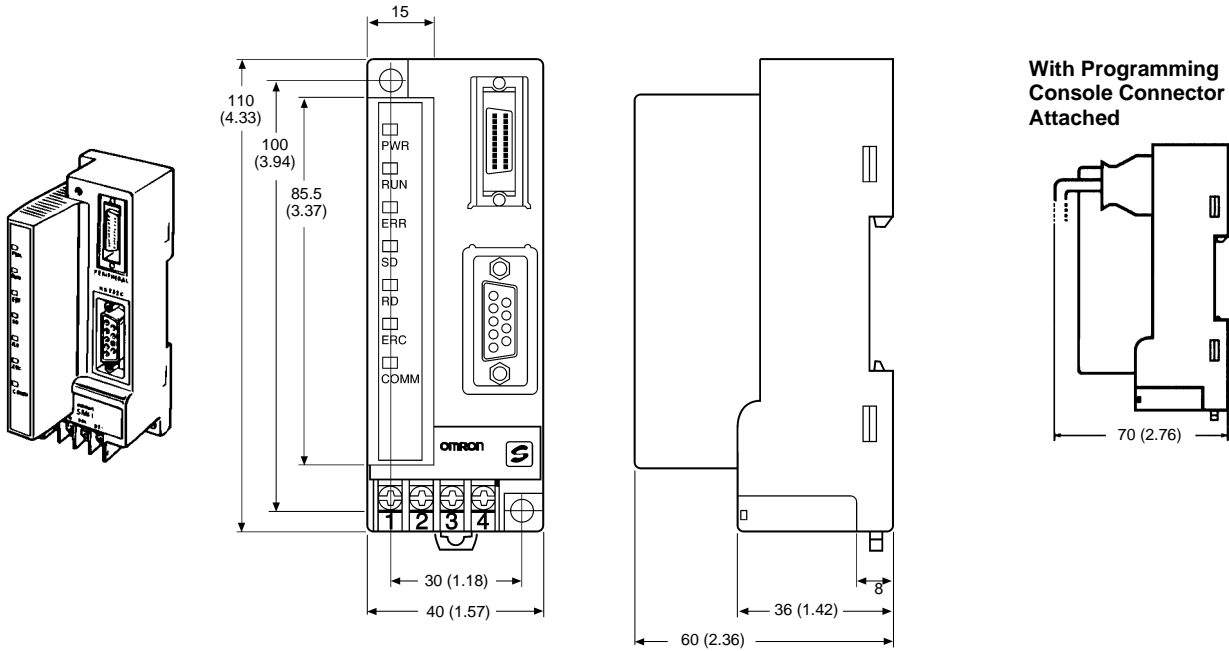

The above dimensions apply to the SRM1-C02-V2. The SRM1-C01-V2 has no RS-232C port.

## ■ COMPOBUS/S SLAVE INPUT AND OUTPUT TERMINALS

SRT1-ID04 (-1), SRT1-OD04 (-1)  
 SRT2-ID04 (-1), SRT2-OD04 (-1)  
 SRT1-ID08 (-1), SRT1-OD08 (-1)  
 SRT2-ID08 (-1), SRT2-OD08 (-1)

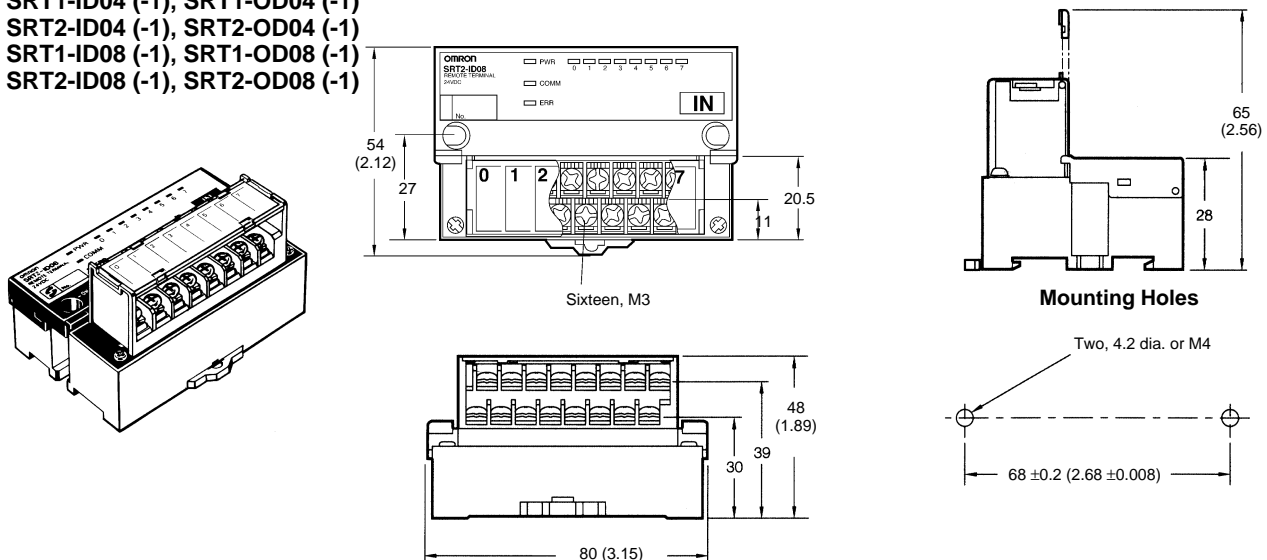



RT1-ID16 (-1), SRT1-OD16 (-1)  
RT2-ID16 (-1), SRT2-OD16 (-1)

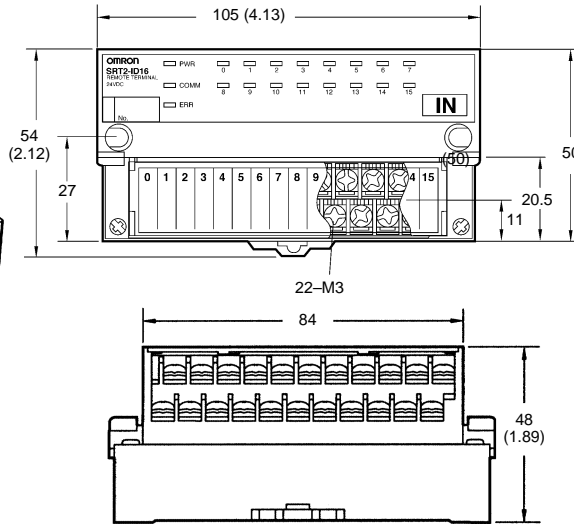
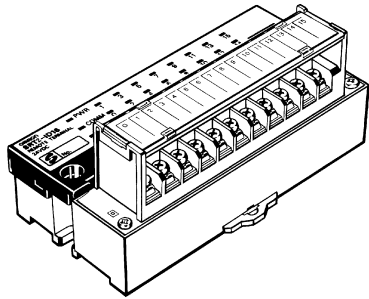

Mounting Holes

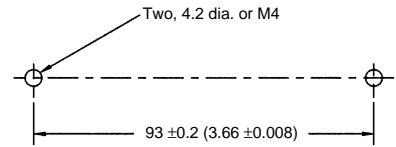

SRT2-ID16T (-1)  
SRT2-MD16T (-1)  
SRT2-OD16T (-1)

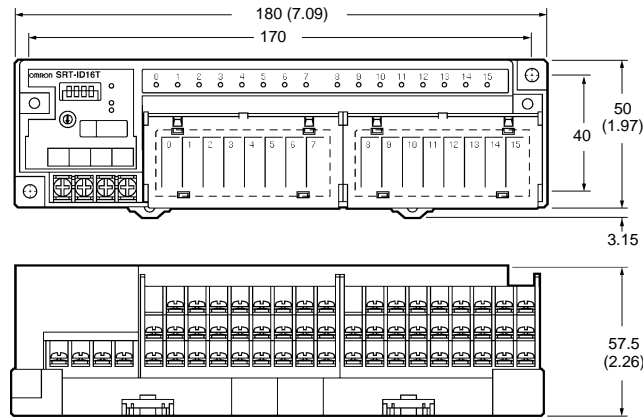
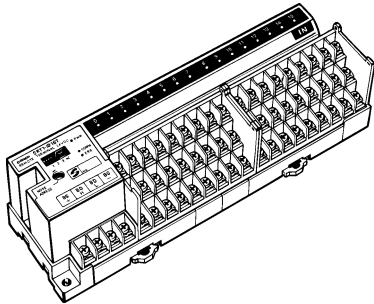

Mounting Holes

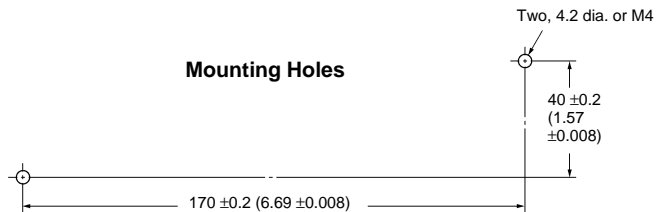

Unit: mm (inch)

**SRT1-ROC08, SRT1-ROF08**  
**SRT2-ROC08, SRT2-ROF08**

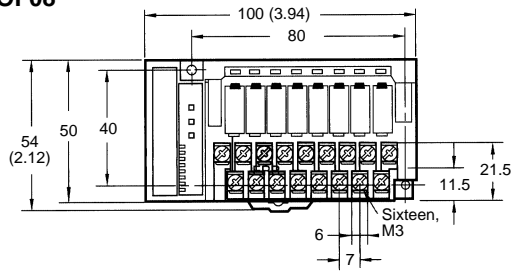
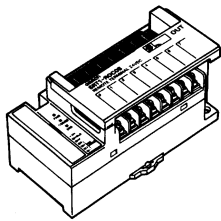

**Mounting Holes**

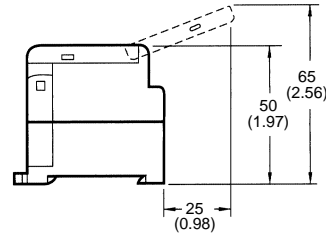
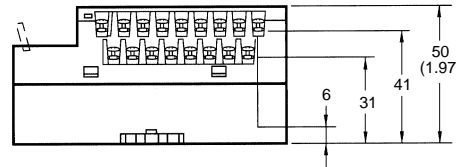
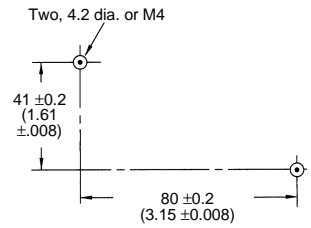

**SRT1-ROC16, SRT1-ROF16**  
**SRT2-ROC16, SRT2-ROF16**

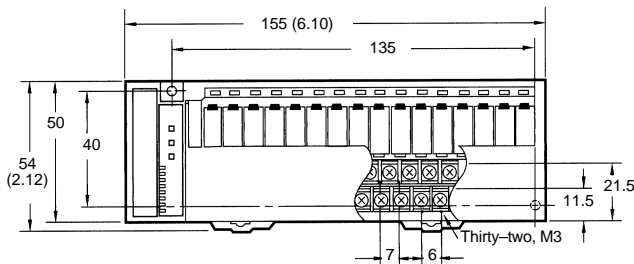
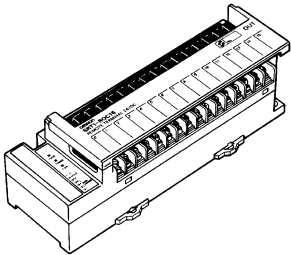

**Mounting Holes**

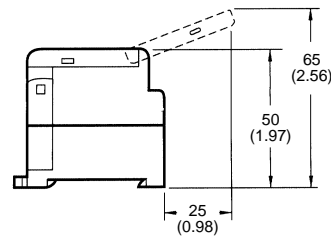
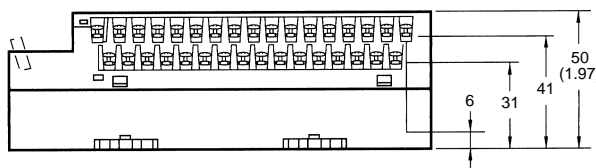
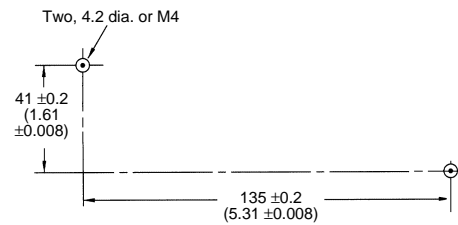

SRT2-VID08S  
 SRT2-VID08S-1  
 SRT2-VOD08S  
 SRT2-VOD08S-1

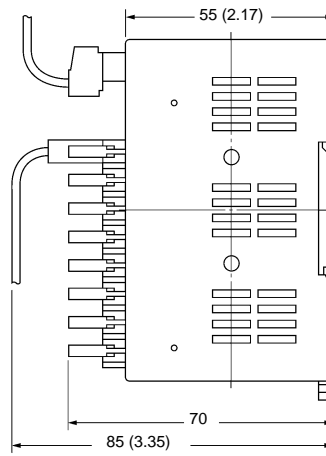
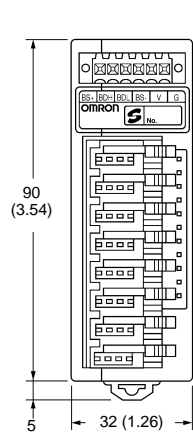
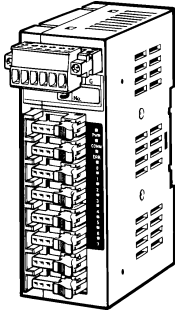

SRT2-VID16ML  
 SRT2-VID16ML-1  
 SRT2-VOD16ML  
 SRT2-VOD16ML-1

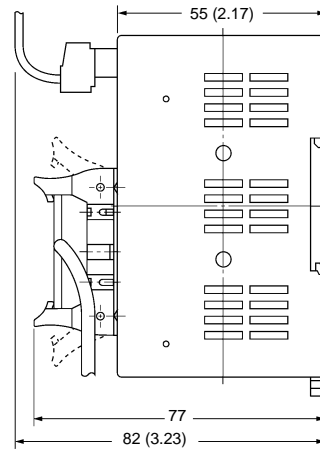
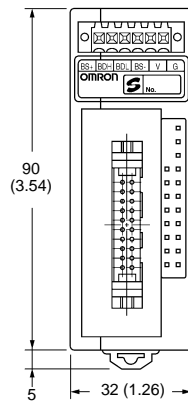
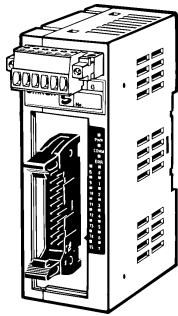

**Mounting Brackets**

SRT2-ATT01

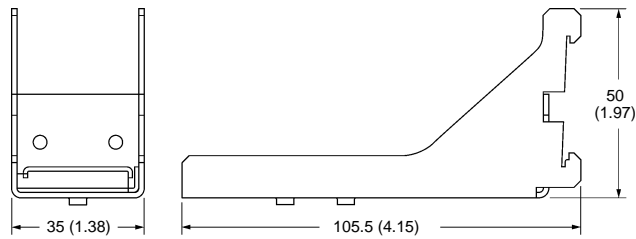

Dimensions when Unit is mounted.

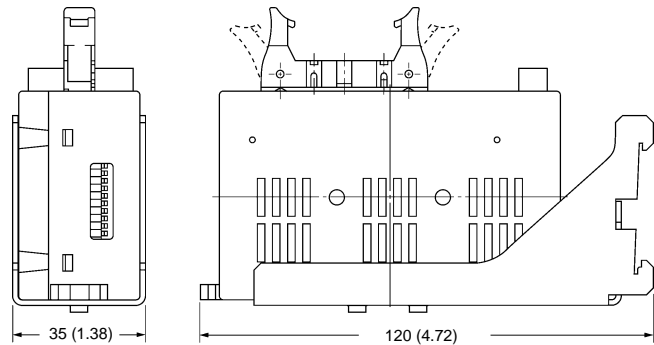

SRT2-ATT02

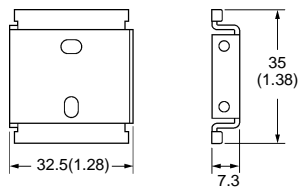

Unit: mm (inch)

RT1-ID08S

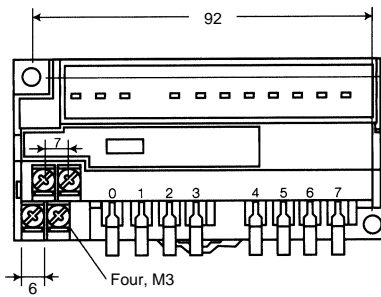
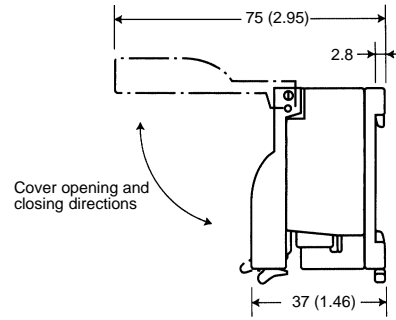
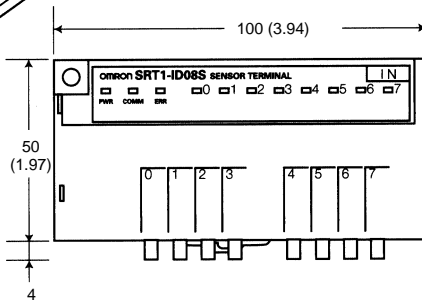
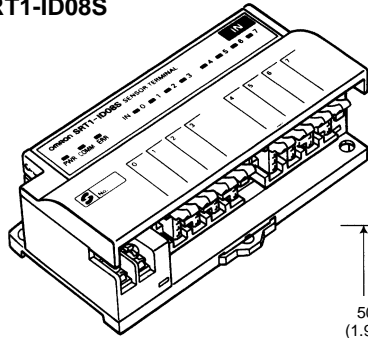

Mounting Holes

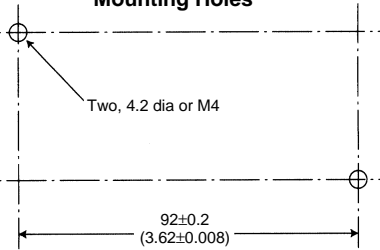

SRT1-ND08S

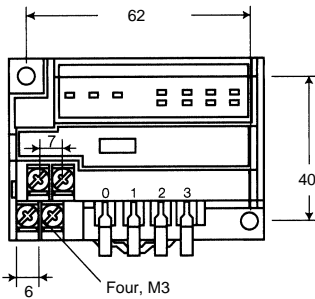
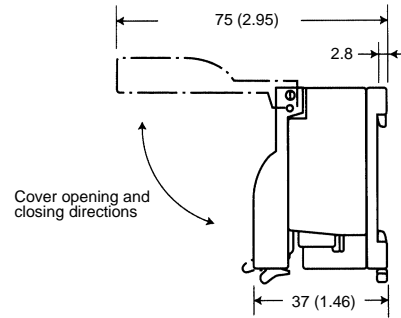
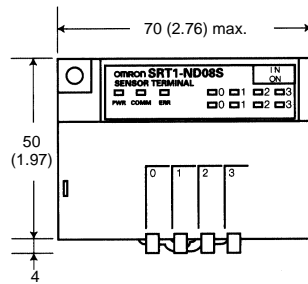
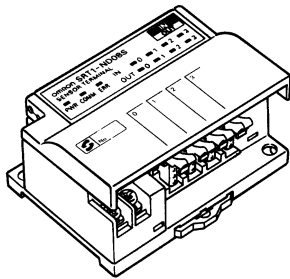

Mounting Holes

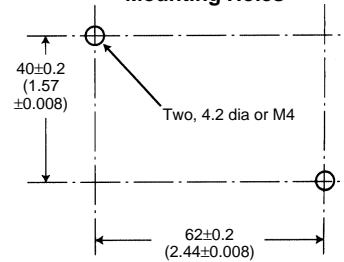

SRT1-OD08S

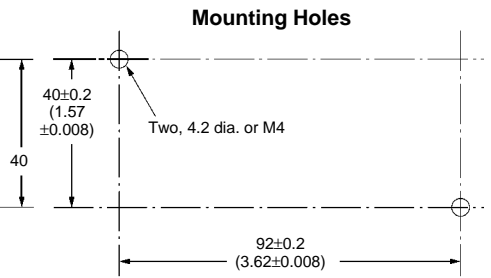
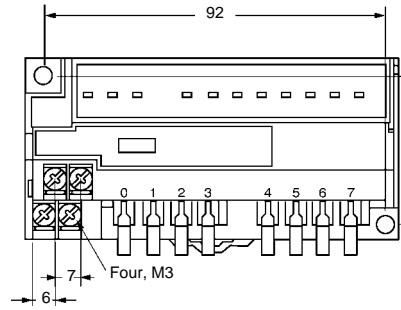
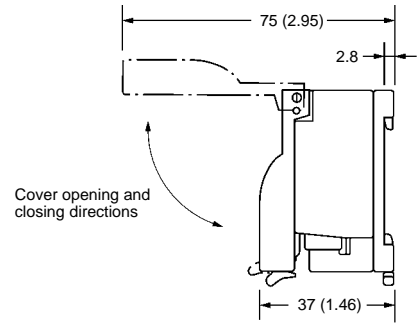
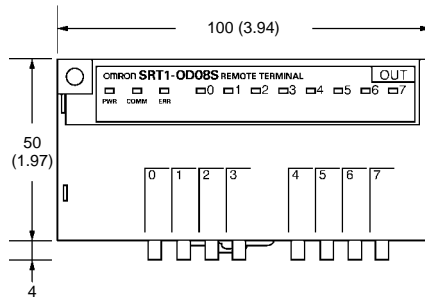
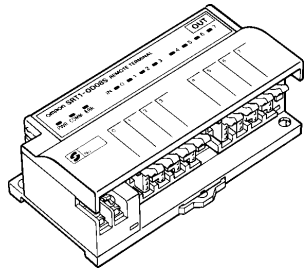

SRT1-TID04

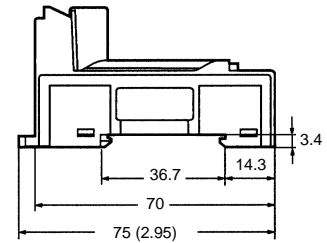
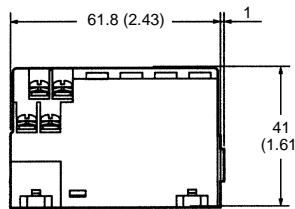
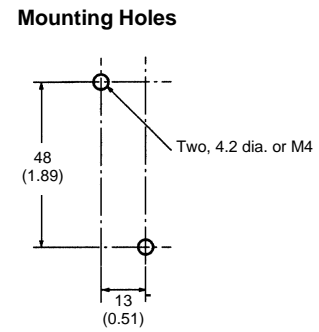
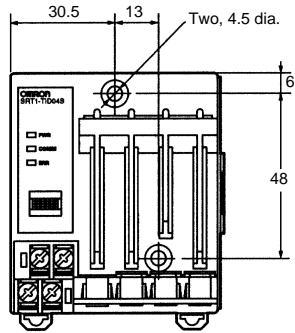
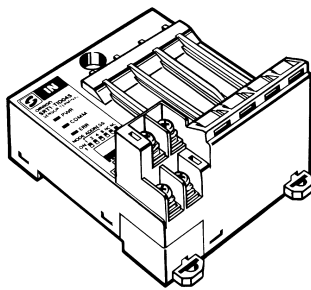

Unit: mm (inch)

**SRT1-XID04S**

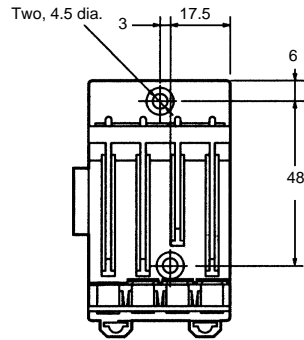
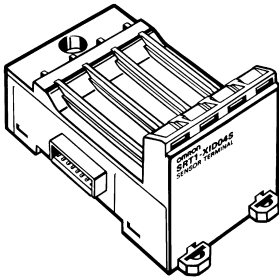

**Mounting Holes**

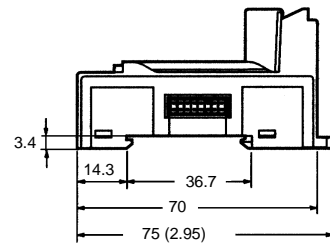
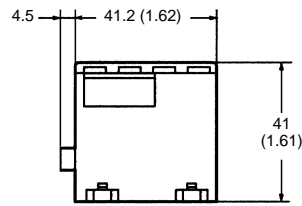
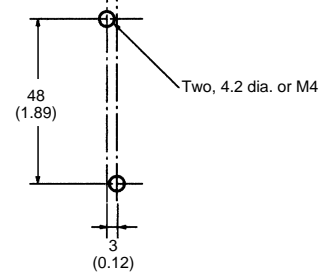

**SRT1-TKD04S**

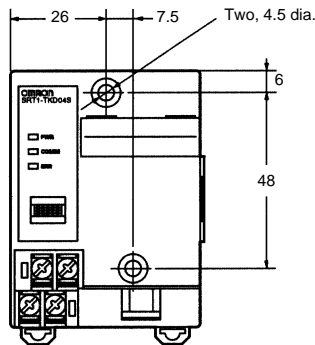
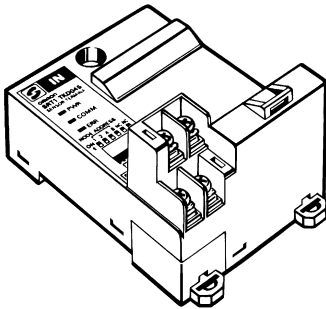

**Mounting Holes**

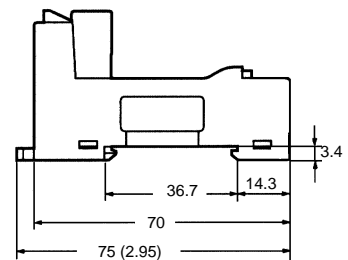
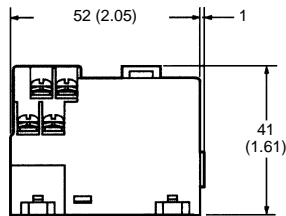
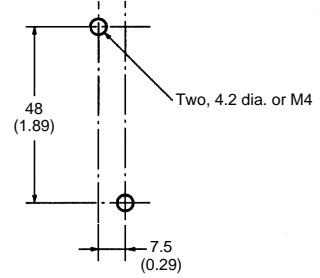

SRT1-XKD04S

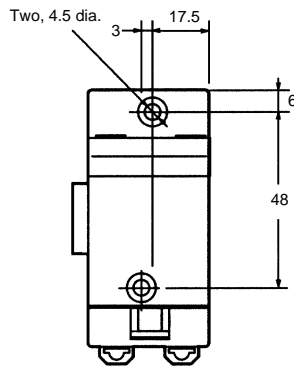
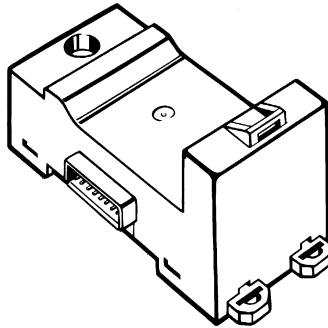

Mounting Holes

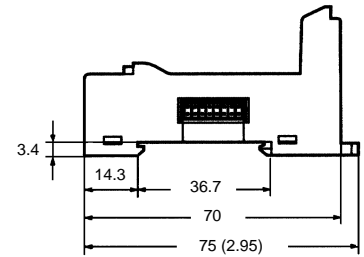
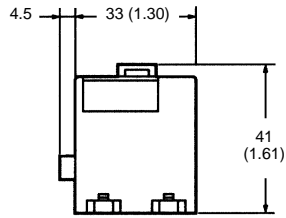
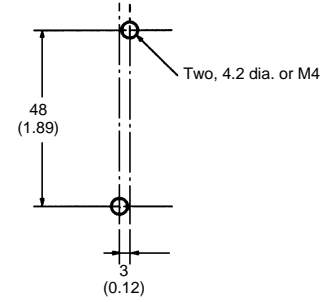

E3X-NM16

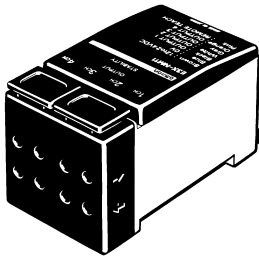

Output indicator      Stability indicator

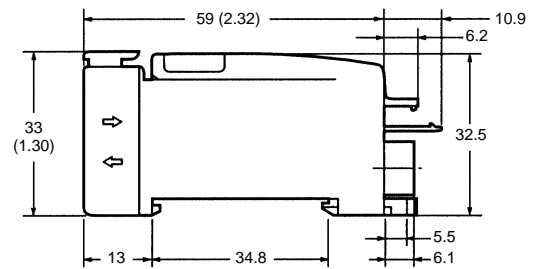
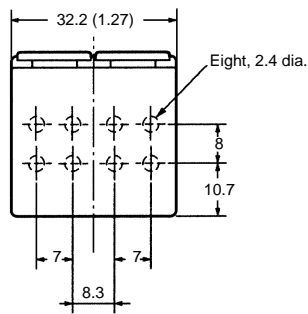
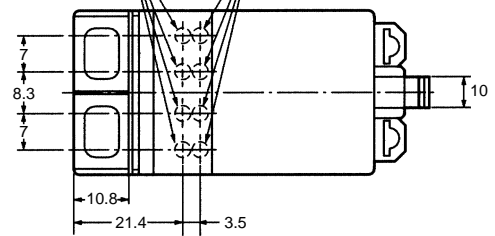

Unit: mm (inch)

E3X-NT□6

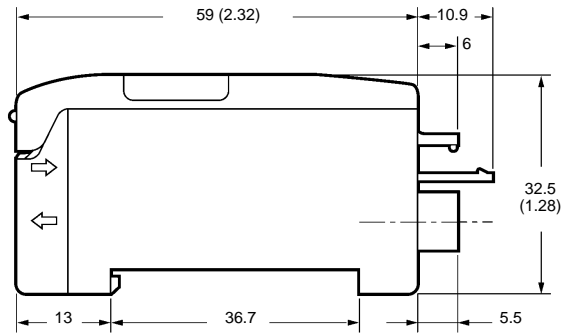
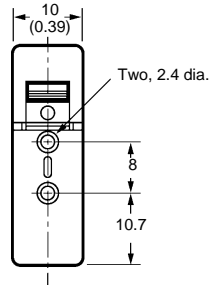
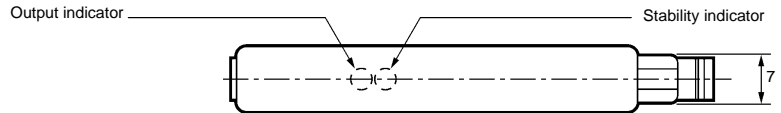
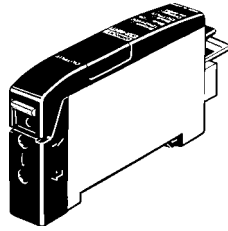

E2C-T16

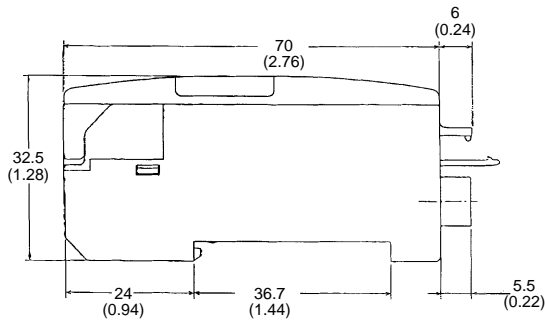
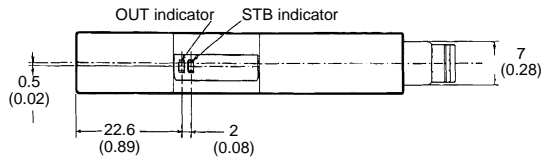
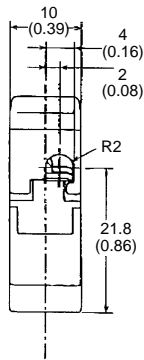
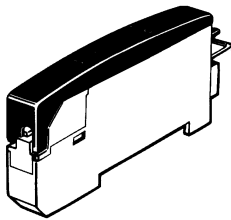

E39-JID01

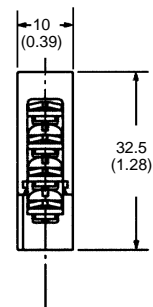
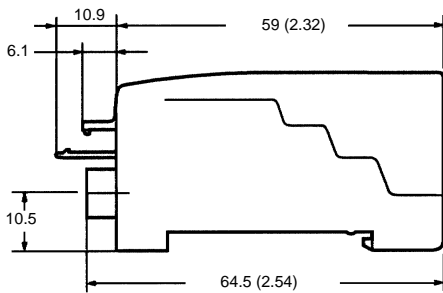
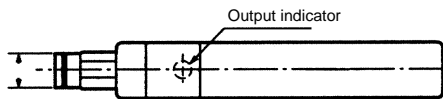
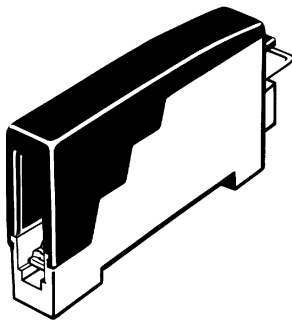



**SRT1-ID16P**  
**SRT1-OD16P**

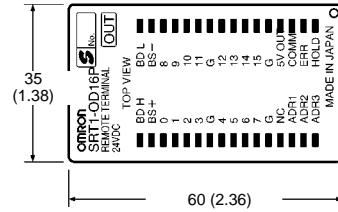
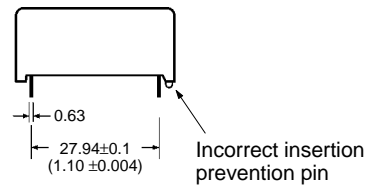
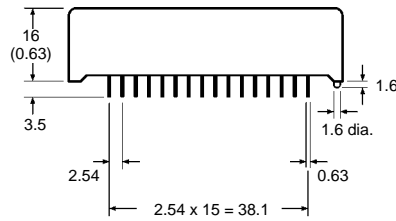
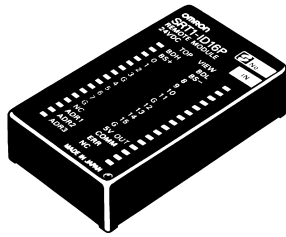

PCB dimensions (top view)

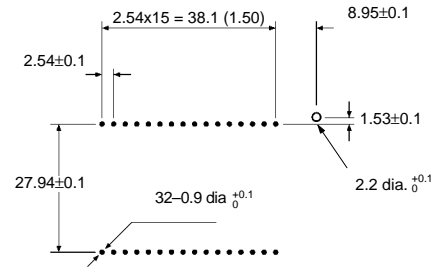

No cumulative tolerance allowed

**SRT2-AD04**

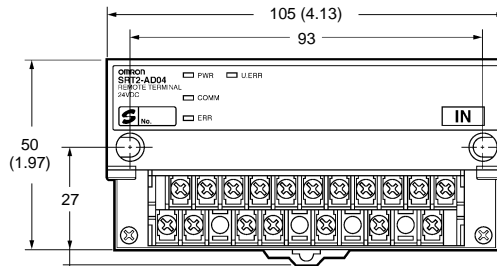
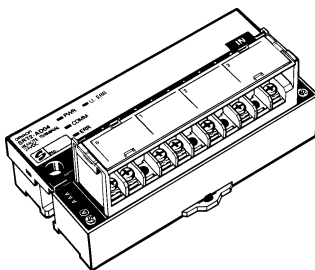

Mounting Holes

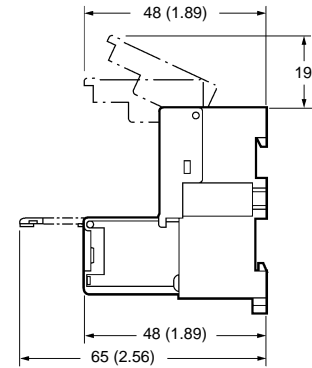
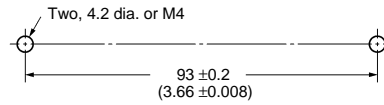

**SRT2-DA02**

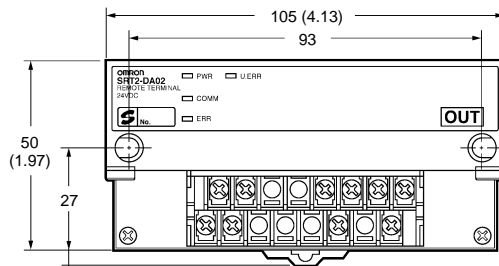
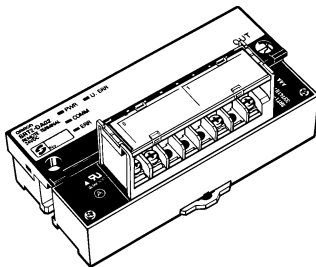

Mounting Holes

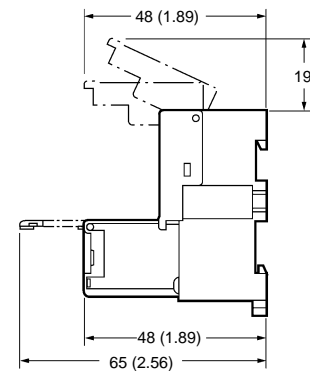
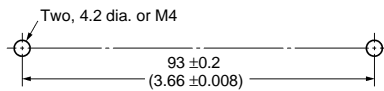

Unit: mm (inch)

■ CONNECTORS, CABLE, TERMINATORS

SCN1-TH4 Branch Connector  
SCN1-TH4E Extension Connector

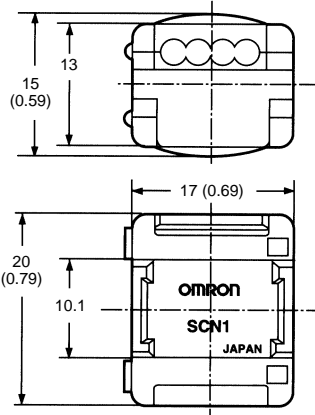
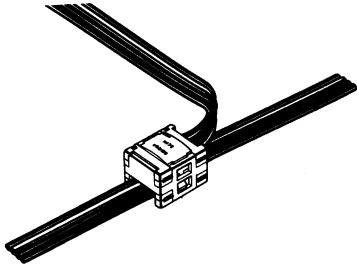

SCN1-TH4T Connector Terminator

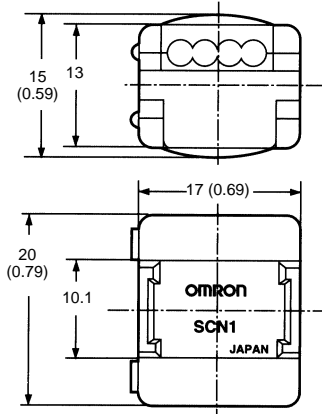
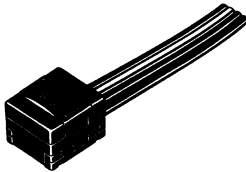

SRS1-T Terminal-block Terminator

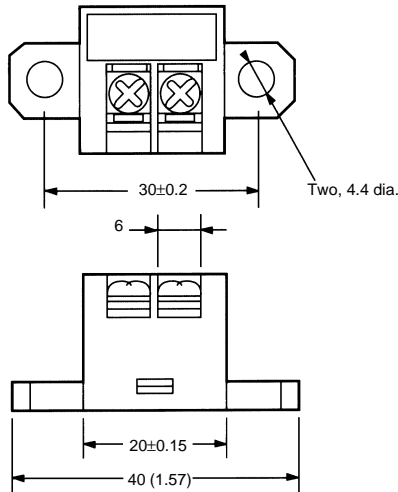
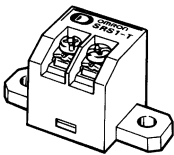

Mounting Holes

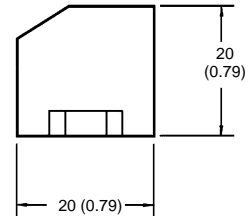
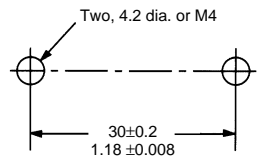

# Communications

## ■ NT LINK FOR PROGRAMMABLE TERMINALS

### 1:1 NT Link

High-speed communications can be achieved by providing a direct access through the use of the 1:1 NT Link between the SRM1 and Omron's NT-Series Programmable Terminals. The RS-232C port can be used for NT Link. The peripheral port can be converted to RS-232C port using the CPM1-CIF01 serial communication adapter.

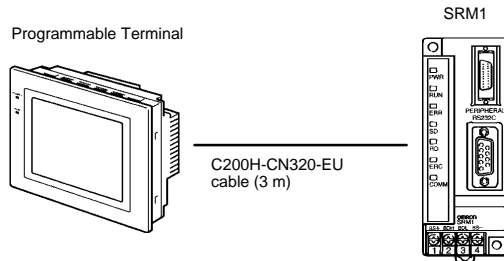

### 1:N NT Link

Connect the SRM1 to several NT-Series Programmable Terminals via the peripheral port using the CPM1-CIF11 serial communication adapter, as shown in the illustration at below. OMRON PTs that support the 1:N NT Link must be used.

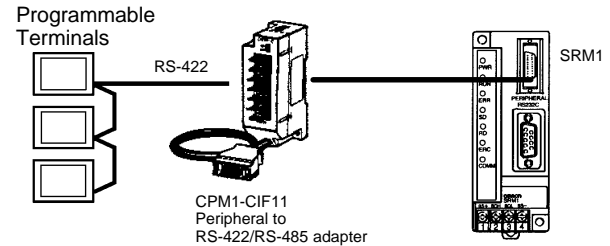

## ■ HOST LINK COMMUNICATIONS

Host Link is a command/response communications system in which commands are transmitted from the host computer and corresponding responses are returned from the destination SRM1. Host Link commands can be used to read/write data in SRM1 data areas and read/write settings. Either the peripheral port or RS-232C port can be used.

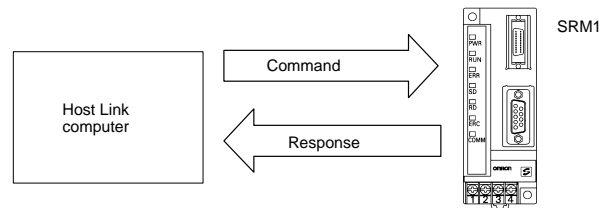

### 1:1 Host Link Connection

The SRM1 can be connected to an IBM PC/AT or compatible computer or a Programmable Terminal, as shown in the following diagram.

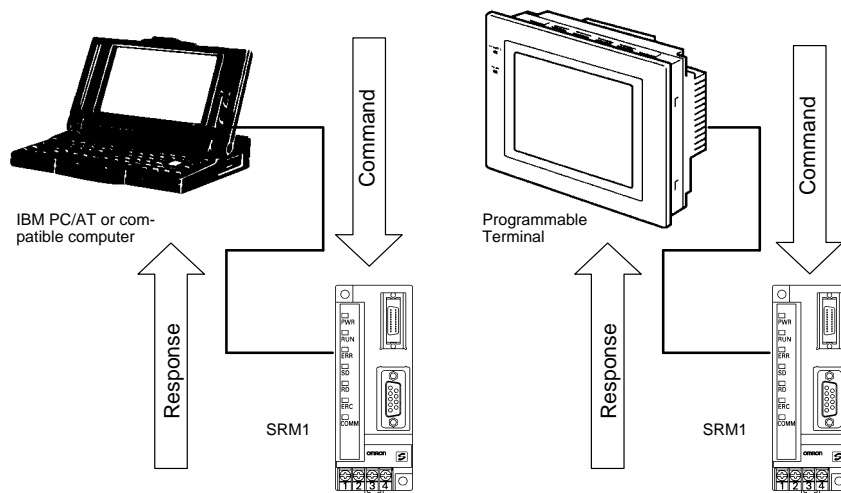

Peripheral Port Connection

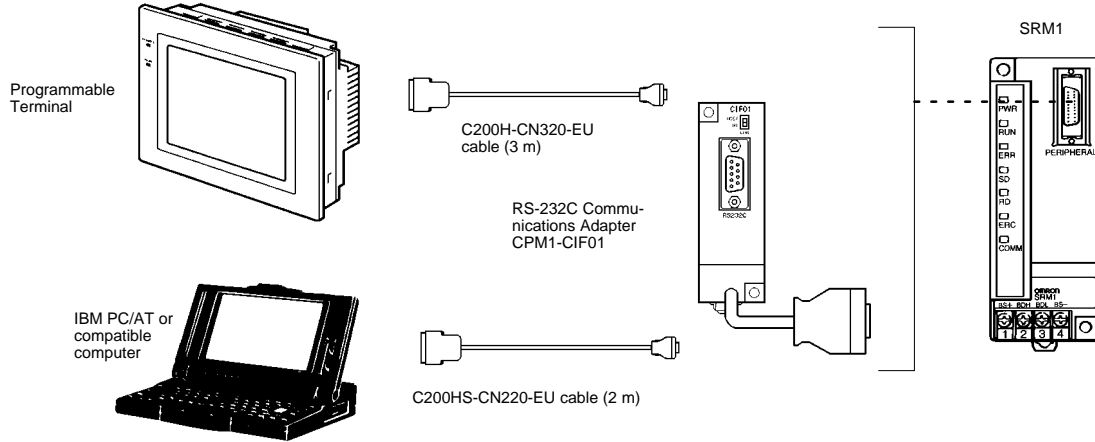

1:N Host Link Connection

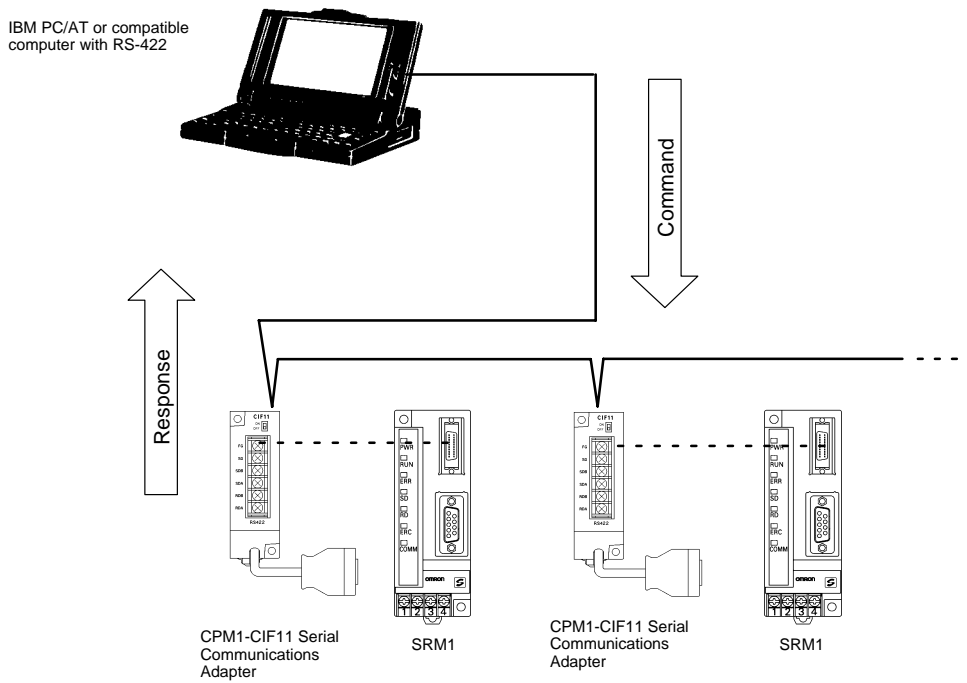

**1:1 LINK CONNECTIONS FOR DATA EXCHANGE**

An SRM1 can share a common data memory area with another SRM1, CQM1, CPM1, CPM1A, CPM2A, CPM2C, C200HS, or C200HX/HE/HG Programmable Controller. One controller acts as the Master and the other as the Slave to link up to 256 bits in the LR area. In the following example, an SRM1 is linked one-to-one to another SRM1. An alternate configuration uses the CPM1-CIF01 serial communication adapter to the peripheral port.

**Restrictions**

The only SRM1 words that can be used for link relay are the words from LR00 to LR15. These words must also be used in the linked programmable controller (CQM1, C200HX/HE/HG/HS or CS1). It is not possible for words LR16 to LR63 to be linked one-to-one with an SRM1.

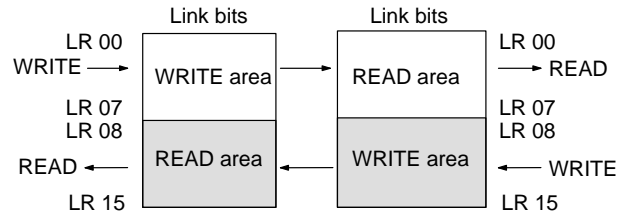
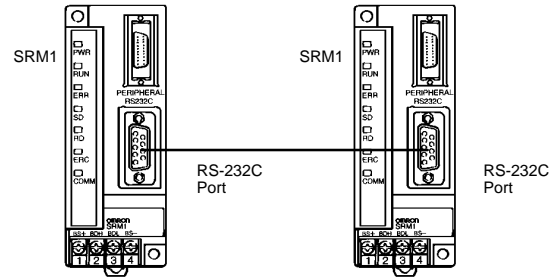

**PROGRAM TRANSFER UNIT**

Use Omron's EEPROM program transfer unit to update programs in machines or program multiple controllers with the same program. The CPM1-EMU01-V1 Expansion Memory Unit connects to the peripheral port of micro and small PLCs.

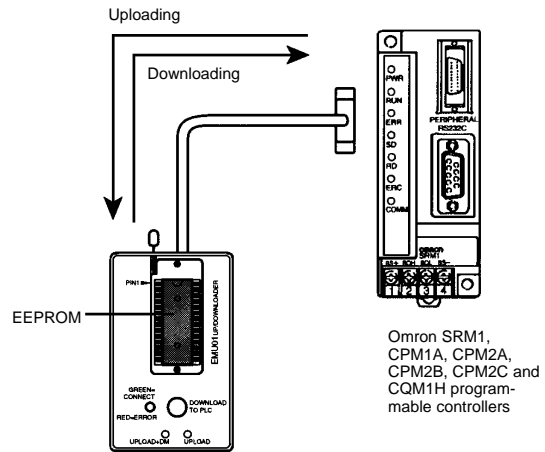

# Instruction Set

## ■ SEQUENCE INSTRUCTIONS

### Sequence Input Instructions

Instruction	Mnemonic	Code
LOAD	LD	○
LOAD NOT	LD NOT	○
AND	AND	○
AND NOT	AND NOT	○
OR	OR	○
OR NOT	OR NOT	○
AND LOAD	AND LD	○
OR LOAD	OR LD	○

### Sequence Output Instructions

Instruction	Mnemonic	Code
OUTPUT	OUT	○
OUT NOT	OUT NOT	○
SET	SET	○
RESET	RSET	○
KEEP	KEEP	11
DIFFERENTIATE UP	DIFU	13
DIFFERENTIATE DOWN	DIFD	14

### Sequence Control Instructions

Instruction	Mnemonic	Code
NO OPERATION	NOP	00
END	END	01
INTERLOCK	IL	02
INTERLOCK CLEAR	ILC	03
JUMP	JMP	04
JUMP END	JME	05

## ■ TIMER/COUNTER INSTRUCTIONS

Instruction	Mnemonic	Code
TIMER	TIM	○
COUNTER	CNT	○
REVERSIBLE COUNTER	CNTR	12
HIGH-SPEED TIMER	TIMH	15

## ■ STEP INSTRUCTIONS

Instruction	Mnemonic	Code
STEP DEFINE	STEP	08
STEP START	SNXT	09

## ■ INCREMENT/DECREMENT

Instruction	Mnemonic	Code
INCREMENT	INC(@)	38
DECREMENT	DEC(@)	39

## ■ BCD/BINARY CALCULATION

Instruction	Mnemonic	Code
BCD ADD	ADD(@)	30
BCD SUBTRACT	SUB(@)	31
BCD MULTIPLY	MUL(@)	32
BCD DIVIDE	DIV(@)	33
BINARY ADD	ADB(@)	50
BINARY SUBTRACT	SBB(@)	51
BINARY MULTIPLY	MLB(@)	52
BINARY DIVIDE	DVB(@)	53
DOUBLE BCD ADD	ADDL(@)	54
DOUBLE BCD SUBTRACT	SUBL(@)	55
DOUBLE BCD MULTIPLY	MULL(@)	56
DOUBLE BCD DIVIDE	DIVL(@)	57

## ■ DATA CONVERSION INSTRUCTIONS

Instruction	Mnemonic	Code
BCD TO BINARY	BIN(@)	23
BINARY TO BCD	BCD(@)	24
4 TO 16 DECODER	MLPX(@)	76
16 TO 4 DECODER	DMPX(@)	77
ASCII CODE CONVERT	ASC(@)	86
2'S COMPLEMENT (-V2 models only)	NEG(@)	—

### Data Comparison Instructions

Instruction	Mnemonic	Code
COMPARE	CMP	20
DOUBLE COMPARE	CMPL†	60
BLOCK COMPARE	BCMP(@)†	68
TABLE COMPARE	TCMP(@)	85
AREA RANGE COMPARE (-V2 models only)	ZCP	—

## ■ DATA MOVEMENT INSTRUCTIONS

Instruction	Mnemonic	Code
MOVE	MOV(@)	21
MOVE NOT	MVN(@)	22
BLOCK TRANSFER	XFER(@)	70
BLOCK SET	BSET(@)	71
DATA EXCHANGE	XCHG(@)	73
SINGLE WORD DISTRIBUTE	DIST(@)	80
DATA COLLECT	COLL(@)	81
MOVE BIT	MOVB(@)	82
MOVE DIGIT	MOVD(@)	83

Note: ○: Instruction keys allocated to the Programming Console.

(@): Instruction can be differentiated using input rise time to execute the instruction in just one cycle.

—: Identifies an expansion instruction.

†: Identifies an expansion instruction assigned a default code.

## ■ LOGIC INSTRUCTIONS

Instruction	Mnemonic	Code
COMPLEMENT	COM(@)	29
LOGICAL AND	ANDW(@)	34
LOGICAL OR	ORW(@)	35
EXCLUSIVE OR	XORW(@)	36
EXCLUSIVE NOR	XNRW(@)	37

## ■ SHIFT INSTRUCTIONS

Instruction	Mnemonic	Code
SHIFT REGISTER	SFT	○/10
WORD SHIFT	WSFT(@)	16
ASYNCHRONOUS SHIFT REGISTER	ASFT(@)†	17
ARITHMETIC SHIFT LEFT	ASL(@)	25
ARITHMETIC SHIFT RIGHT	ASR(@)	26
ROTATE LEFT	ROL(@)	27
ROTATE RIGHT	ROR(@)	28
ONE DIGIT SHIFT LEFT	SLD(@)	74
ONE DIGIT SHIFT RIGHT	SRD(@)	75
REVERSIBLE SHIFT REGISTER	SFTR(@)	84

## ■ SPECIAL CALCULATION INSTRUCTION

Instruction	Mnemonic	Code
BIT COUNTER	BCNT(@)†	67

## ■ SUBROUTINE INSTRUCTIONS

Instruction	Mnemonic	Code
SUBROUTINE ENTER	SBS(@)	91
SUBROUTINE ENTRY	SBN	92
SUBROUTINE RETURN	RET	93
MACRO	MCRO	99

## ■ INTERRUPT CONTROL INSTRUCTIONS

Instruction	Mnemonic	Code
INTERVAL TIMER	STIM(@)†	69
INTERRUPT CONTROL	INT(@)†	89

## ■ PERIPHERAL DEVICE CONTROL

### I/O Unit Instructions

Instruction	Mnemonic	Code
7-SEGMENT DECODER	SDEC(@)	78
I/O REFRESH	IORF(@)	97

### Display Instruction

Instruction	Mnemonic	Code
MESSAGE	MSG(@)	46

### High-speed Counter Control Instructions

Instruction	Mnemonic	Code
MODE CONTROL	INI(@)†	61
PV READ	PRV(@)†	62
COMPARE TABLE LOAD	CTBL(@)†	63

## ■ DAMAGE DIAGNOSIS INSTRUCTIONS

Instruction	Mnemonic	Code
FAILURE ALARM	FAL(@)	06
SEVERE FAILURE ALARM	FALS	07

## ■ SPECIAL SYSTEM INSTRUCTIONS

Instruction	Mnemonic	Code
SET CARRY	STC(@)	40
CLEAR CARRY	CLC(@)	41

## ■ RS-232C INSTRUCTIONS

Instruction	Mnemonic	Code
RECEIVE	RXD(@)†	47
TRANSMIT	TXD(@)†	48
FCS CALCULATE	FCS(@)	—
ASCII-TO-HEXADECIMAL	HEX(@)	—
CHANGE RS-232C SETUP	STUP(@)	—

## ■ DATA CONTROL INSTRUCTIONS

Instruction	Mnemonic	Code
SCALE (-V2 models only)	SCL(@)†	66
PID CONTROL (-V2 models only)	PID	—

Note: ○: Instruction keys allocated to the Programming Console.

(@): Instruction can be differentiated using input rise time to execute the instruction in just one cycle.

—: Identifies an expansion instruction.

†: Identifies an expansion instruction assigned a default code.

## INSTRUCTION SET SUMMARY

The following table lists the SRM1(-V2) instructions that have fixed function codes. Each instruction is listed by mnemonic and by instruction name. Use the numbers in the leftmost column as the left digit and the number in the column heading as the right digit of the function code.

The shaded areas are function codes to which expansion instructions are allocated by default or to which the user can allocate expansion instructions. The expansion instructions shown at the bottom of the page can be substituted for the ones with default function codes.

Left digit	Right digit									
	0	1	2	3	4	5	6	7	8	9
0	<b>NOP</b> No operation	<b>END</b> End	<b>IL</b> Interlock	<b>ILC</b> Interlock clear	<b>JMP</b> Jump	<b>JME</b> Jump end	<b>FAL(@)</b> Failure alarm and reset	<b>FALS</b> Severe failure alarm	<b>STEP</b> Step define	<b>SNXT</b> Step start
1	<b>SFT</b> Shift register	<b>KEEP</b> Keep	<b>CNTR</b> Reversible counter	<b>DIFU</b> Differentiate up	<b>DIFD</b> Differentiate down	<b>TIMH</b> High-speed timer	<b>WSFT(@)</b> Word shift	<b>ASFT(@)</b> Asynchronous shift register	---	---
2	<b>CMP</b> Compare	<b>MOV(@)</b> Move	<b>MVN(@)</b> Move not	<b>BIN(@)</b> BCD to binary	<b>BCD(@)</b> Binary to BCD	<b>ASL(@)</b> Shift left	<b>ASR(@)</b> Shift right	<b>ROL(@)</b> Rotate left	<b>ROR(@)</b> Rotate right	<b>COM(@)</b> Complement
3	<b>ADD(@)</b> BCD add	<b>SUB(@)</b> BCD subtract	<b>MUL(@)</b> BCD multiply	<b>DIV(@)</b> BCD divide	<b>ANDW(@)</b> Logical AND	<b>ORW(@)</b> Logical OR	<b>XORW(@)</b> Exclusive OR	<b>XNRW(@)</b> Exclusive NOR	<b>INC(@)</b> Increment	<b>DEC(@)</b> Decrement
4	<b>STC(@)</b> Set carry	<b>CLC(@)</b> Clear carry	---	---	---	---	<b>MSG(@)</b> Message display	<b>RXD(@)</b> Receive	<b>TXD(@)</b> Transmit	---
5	<b>ADB(@)</b> Binary add	<b>SBB(@)</b> Binary subtract	<b>MLB(@)</b> Binary multiply	<b>DVB(@)</b> Binary divide	<b>ADDL(@)</b> Double BCD add	<b>SUBL(@)</b> Double BCD subtract	<b>MULL(@)</b> Double BCD multiply	<b>DIVL(@)</b> Double BCD divide	---	---
6	<b>CMPL</b> Double compare	<b>INI(@)</b> Mode control	<b>PRV(@)</b> PV read	<b>CTBL(@)</b> Compare table load	---	---	<b>SCL(@)</b> Scaling (See Note)	<b>BCNT(@)</b> Bit counter	<b>BCMP(@)</b> Block compare	<b>STIM(@)</b> Interval timer
7	<b>XFER(@)</b> Block transfer	<b>BSET(@)</b> Block set	---	<b>XCHG(@)</b> Data exchange	<b>SLD(@)</b> One digit shift left	<b>SRD(@)</b> One digit shift right	<b>MLPX(@)</b> 4-to-16 decoder	<b>DMPX(@)</b> 16-to-4 encoder	<b>SDEC(@)</b> 7-segment decoder	---
8	<b>DIST(@)</b> Single word distribute	<b>COLL(@)</b> Data collect	<b>MOVB(@)</b> Move bit	<b>MOVD(@)</b> Move digit	<b>SFTR(@)</b> Reversible shift register	<b>TCMP(@)</b> Table compare	<b>ASC(@)</b> ASCII convert	---	---	<b>INT(@)</b> Interrupt control
9	---	<b>SBS(@)</b> Subroutine entry	<b>SBN</b> Subroutine define	<b>RET</b> Subroutine return	---	---	---	---	---	<b>MCRO(@)</b> Macro

## EXPANSION INSTRUCTIONS WITHOUT DEFAULT FUNCTION CODES

Mnemonic	Name
<b>FCS(@)</b>	FCS CALCULATE
<b>HEX(@)</b>	ASCII-TO-HEXADECIMAL
<b>NEG(@)*</b>	2'S COMPLEMENT
<b>PID*</b>	PID CONTROL
<b>STUP(@)</b>	CHANGE RS-232C SETUP
<b>ZCP*</b>	AREA RANGE COMPARE

Note: \*SCL(66), NEG(—), PID(—), and ZCP (—) are supported by the SRM1-C0□-V2 CPUs only.



**NOTE: DIMENSIONS SHOWN ARE IN MILLIMETERS. To convert millimeters to inches divide by 25.4.**

---

**OMRON**<sup>®</sup>  
**OMRON ELECTRONICS LLC**  
One East Commerce Drive  
Schaumburg, IL 60173  
**1-800-55-OMRON**

**OMRON CANADA, INC.**  
885 Milner Avenue  
Scarborough, Ontario M1B 5V8  
**416-286-6465**