

## P-Channel 20 V (D-S) MOSFET with Schottky Diode

MOSFET PRODUCT SUMMARY			
V <sub>DS</sub> (V)	R <sub>DS(on)</sub> (Ω)	I <sub>D</sub> (A)	Q <sub>g</sub> (Typ.)
- 20	0.105 at V <sub>GS</sub> = - 4.5 V	- 4 <sup>a</sup>	4.7 nC
	0.143 at V <sub>GS</sub> = - 2.5 V	- 3.8	
	0.188 at V <sub>GS</sub> = - 1.8 V	- 3	

SCHOTTKY PRODUCT SUMMARY		
V <sub>KA</sub> (V)	V <sub>f</sub> (V) Diode Forward Voltage	I <sub>F</sub> (A)
20	0.46 at 0.5 A	1

### FEATURES

- Halogen-free According to IEC 61249-2-21 Definition
- LITTLE FOOT® Plus Schottky Power MOSFET
- Compliant to RoHS Directive 2002/95/EC



**RoHS**  
COMPLIANT  
HALOGEN  
**FREE**  
Available

### APPLICATIONS

- Charging Switch for Portable Devices  
- With Integrated Low V<sub>f</sub> Trench Schottky Diode

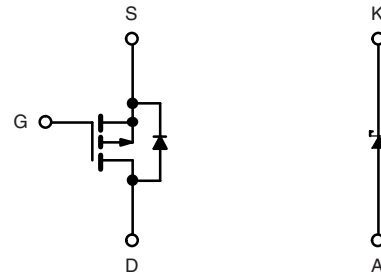
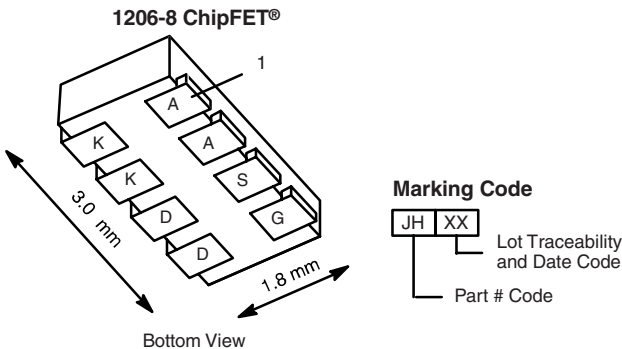

Ordering Information: Si5853DDC-T1-E3 (Lead (Pb)-free)  
Si5853DDC-T1-GE3 (Lead (Pb)-free and Halogen-free)

P-Channel MOSFET

ABSOLUTE MAXIMUM RATINGS T <sub>A</sub> = 25 °C, unless otherwise noted					
Parameter	Symbol	Limit	Unit		
Drain-Source Voltage (MOSFET)	V <sub>DS</sub>	- 20	V		
Reverse Voltage (Schottky)	V <sub>KA</sub>	20			
Gate-Source Voltage (MOSFET)	V <sub>GS</sub>	± 8			
Continuous Drain Current (T <sub>J</sub> = 150 °C) (MOSFET)	I <sub>D</sub>	T <sub>C</sub> = 25 °C	- 4 <sup>a</sup>	A	
		T <sub>C</sub> = 70 °C	- 3.5		
		T <sub>A</sub> = 25 °C	- 2.9 <sup>b, c</sup>		
		T <sub>A</sub> = 70 °C	- 2.3 <sup>b, c</sup>		
Pulsed Drain Current (MOSFET)	I <sub>DM</sub>	- 10			
Continuous Source Current (MOSFET Diode Conduction)	I <sub>S</sub>	T <sub>C</sub> = 25 °C	- 2.6		
		T <sub>A</sub> = 25 °C	- 1.1 <sup>b, c</sup>		
Average Forward Current (Schottky)	I <sub>F</sub>	1			
Pulsed Forward Current (Schottky)	I <sub>FM</sub>	3			
Maximum Power Dissipation (MOSFET)	P <sub>D</sub>	T <sub>C</sub> = 25 °C	3.1	W	
		T <sub>C</sub> = 70 °C	2		
		T <sub>A</sub> = 25 °C	1.3 <sup>b, c</sup>		
		T <sub>A</sub> = 70 °C	0.8 <sup>b, c</sup>		
Maximum Power Dissipation (Schottky)	P <sub>D</sub>	T <sub>C</sub> = 25 °C	2.5		
		T <sub>C</sub> = 70 °C	1.6		
		T <sub>A</sub> = 25 °C	1.2		
		T <sub>A</sub> = 70 °C	0.76		
Operating Junction and Storage Temperature Range	T <sub>J</sub> , T <sub>stg</sub>	- 55 to 150	°C		
Soldering Recommendation (Peak Temperature) <sup>d, e</sup>		260			

**THERMAL RESISTANCE RATINGS**

Parameter	Symbol	Typical	Maximum	Unit
Maximum Junction-to-Ambient (MOSFET) <sup>b, c, f</sup>	$R_{thJA}$	77	95	°C/W
Maximum Junction-to-Foot (Drain) (MOSFET)	$R_{thJF}$	33	40	
Maximum Junction-to-Ambient (Schottky) <sup>b, c, g</sup>	$R_{thJA}$	85	105	
Maximum Junction-to-Foot (Drain) (Schottky)	$R_{thJF}$	40	50	

Notes:

- Package limited.
- Surface mounted on FR4 board.
- $t \leq 5$  s.
- See Solder Profile ([www.vishay.com/doc?73257](http://www.vishay.com/doc?73257)). The ChipFET is a leadless package. The end of the lead terminal is exposed copper (not plated) as a result of the singulation process in manufacturing. A solder fillet at the exposed copper tip cannot be guaranteed and is not required to ensure adequate bottom side solder interconnection.
- Rework conditions: manual soldering with a soldering iron is not recommended for leadless components.
- Maximum under steady state conditions for MOSFETs is 130 °C/W.
- Maximum under steady state conditions for Schottky is 125 °C/W.

**SPECIFICATIONS**  $T_J = 25$  °C, unless otherwise noted

Parameter	Symbol	Test Conditions	Min.	Typ.	Max.	Unit
<b>Static</b>						
Drain-Source Breakdown Voltage	$V_{DS}$	$V_{GS} = 0$ V, $I_D = -250$ $\mu$ A	-20			V
$V_{DS}$ Temperature Coefficient	$\Delta V_{DS/TJ}$	$I_D = -250$ $\mu$ A		-13		mV/°C
$V_{GS(th)}$ Temperature Coefficient	$\Delta V_{GS(th)/TJ}$		2.4			
Gate-Source Threshold Voltage	$V_{GS(th)}$	$V_{DS} = V_{GS}$ , $I_D = -250$ $\mu$ A	-0.4		-1	V
Gate-Body Leakage	$I_{GSS}$	$V_{DS} = 0$ V, $V_{GS} = \pm 8$ V			$\pm 100$	nA
Zero Gate Voltage Drain Current	$I_{DSS}$	$V_{DS} = -20$ V, $V_{GS} = 0$ V			-1	$\mu$ A
		$V_{DS} = -20$ V, $V_{GS} = 0$ V, $T_J = 85$ °C			-10	
On-State Drain Current <sup>a</sup>	$I_{D(on)}$	$V_{DS} \leq -5$ V, $V_{GS} = -4.5$ V	-10			A
Drain-Source On-State Resistance <sup>a</sup>	$R_{DS(on)}$	$V_{GS} = -4.5$ V, $I_D = -2.9$ A		0.085	0.105	$\Omega$
		$V_{GS} = -2.5$ V, $I_D = -2.5$ A		0.117	0.143	
		$V_{GS} = -1.8$ V, $I_D = -1.5$ A		0.155	0.188	
Forward Transconductance <sup>a</sup>	$g_{fs}$	$V_{DS} = -10$ V, $I_D = -2.9$ A		7		S
<b>Dynamic<sup>b</sup></b>						
Input Capacitance	$C_{iss}$	$V_{DS} = -10$ V, $V_{GS} = 0$ V, $f = 1$ MHz		320		pF
Output Capacitance	$C_{oss}$		60			
Reverse Transfer Capacitance	$C_{rss}$		47			
Total Gate Charge	$Q_g$	$V_{DS} = -10$ V, $V_{GS} = -8$ V, $I_D = -2.9$ A		7.9	12	nC
		$V_{DS} = -10$ V, $V_{GS} = -4.5$ V, $I_D = -2.9$ A		4.7	7.1	
Gate-Source Charge	$Q_{gs}$			0.65		
Gate-Drain Charge	$Q_{gd}$		1.35			
Gate Resistance	$R_g$	$f = 1$ MHz		6.5		$\Omega$
Turn-On Delay Time	$t_{d(on)}$	$V_{DD} = -10$ V, $R_L = 4.4$ $\Omega$ $I_D \cong -2.3$ A, $V_{GEN} = -4.5$ V, $R_g = 1$ $\Omega$		15	25	ns
Rise Time	$t_r$			17	30	
Turn-Off Delay Time	$t_{d(off)}$			21	30	
Fall Time	$t_f$			10	15	
Turn-On Delay Time	$t_{d(on)}$	$V_{DD} = -10$ V, $R_L = 4.4$ $\Omega$ $I_D \cong -2.3$ A, $V_{GEN} = -8$ V, $R_g = 1$ $\Omega$		5	10	
Rise Time	$t_r$			10	15	
Turn-Off Delay Time	$t_{d(off)}$			20	30	
Fall Time	$t_f$			10	15	

<b>SPECIFICATIONS</b> $T_J = 25\text{ }^\circ\text{C}$ , unless otherwise noted						
Parameter	Symbol	Test Conditions	Min.	Typ.	Max.	Unit
<b>Drain-Source Body Diode Characteristics</b>						
Continuous Source-Drain Diode Current	$I_S$	$T_C = 25\text{ }^\circ\text{C}$			- 2.6	A
Pulse Diode Forward Current	$I_{SM}$				- 10	
Body Diode Voltage	$V_{SD}$	$I_S = - 2.3\text{ A}$ , $V_{GS} = 0\text{ V}$		- 0.85	- 1.2	V
Body Diode Reverse Recovery Time	$t_{rr}$	$I_F = - 2.3\text{ A}$ $di/dt = 100\text{ A}/\mu\text{s}$ $T_J = 25\text{ }^\circ\text{C}$		15	30	ns
Body Diode Reverse Recovery Charge	$Q_{rr}$			9	20	nC
Reverse Recovery Fall Time	$t_a$			10		ns
Reverse Recovery Rise Time	$t_b$			5		

Notes:

- Pulse test; pulse width  $\leq 300\text{ }\mu\text{s}$ , duty cycle  $\leq 2\%$ .
- Guaranteed by design, not subject to production testing.

<b>SCHOTTKY SPECIFICATIONS</b> $T_J = 25\text{ }^\circ\text{C}$ , unless otherwise noted						
Parameter	Symbol	Test Conditions	Min.	Typ.	Max.	Unit
Forward Voltage Drop	$V_F$	$I_F = 0.5\text{ A}$		0.381	0.46	V
		$I_F = 1\text{ A}$		0.468	0.560	
		$I_F = 1\text{ A}$ , $T_J = 125\text{ }^\circ\text{C}$		0.44	0.53	
Maximum Reverse Leakage Current	$I_{rm}$	$V_r = 5\text{ V}$		0.0081	0.080	mA
		$V_r = 5\text{ V}$ , $T_J = 85\text{ }^\circ\text{C}$		0.4	4	
		$V_r = 5\text{ V}$ , $T_J = 125\text{ }^\circ\text{C}$		2.8	28	
		$V_r = 20\text{ V}$		0.0093	0.09	
		$V_r = 20\text{ V}$ , $T_J = 85\text{ }^\circ\text{C}$		0.45	4.5	
		$V_r = 20\text{ V}$ , $T_J = 125\text{ }^\circ\text{C}$		3.2	32	
Junction Capacitance	$C_T$	$V_r = 10\text{ V}$		30		pF

Stresses beyond those listed under "Absolute Maximum Ratings" may cause permanent damage to the device. These are stress ratings only, and functional operation of the device at these or any other conditions beyond those indicated in the operational sections of the specifications is not implied. Exposure to absolute maximum rating conditions for extended periods may affect device reliability.

## MOSFET TYPICAL CHARACTERISTICS 25 °C, unless otherwise noted

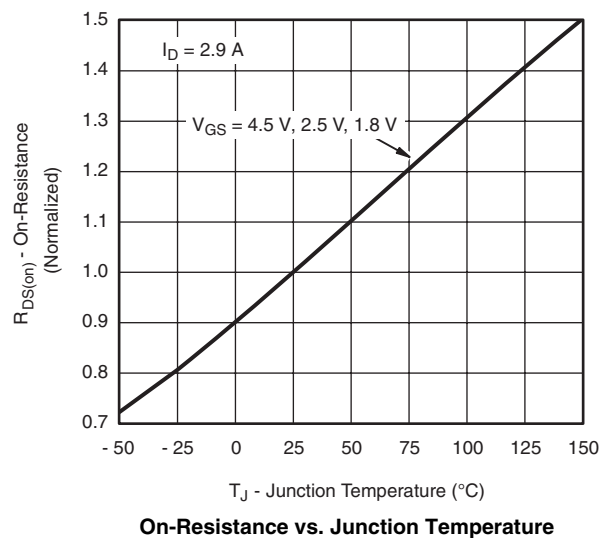
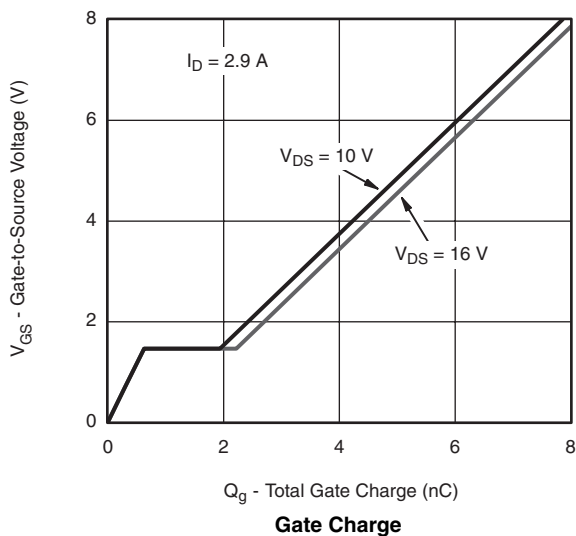
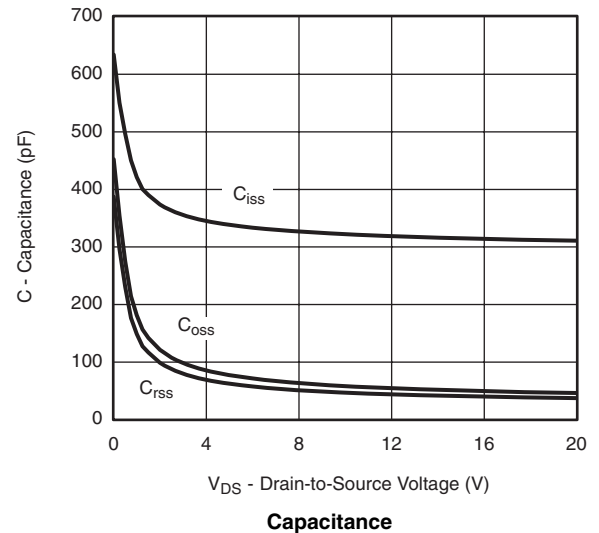
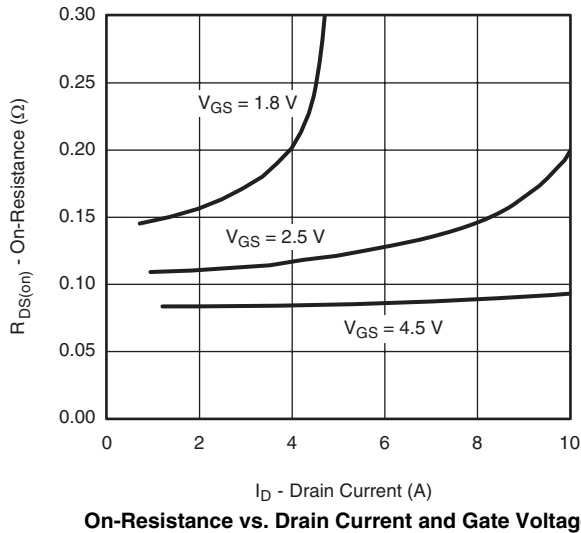
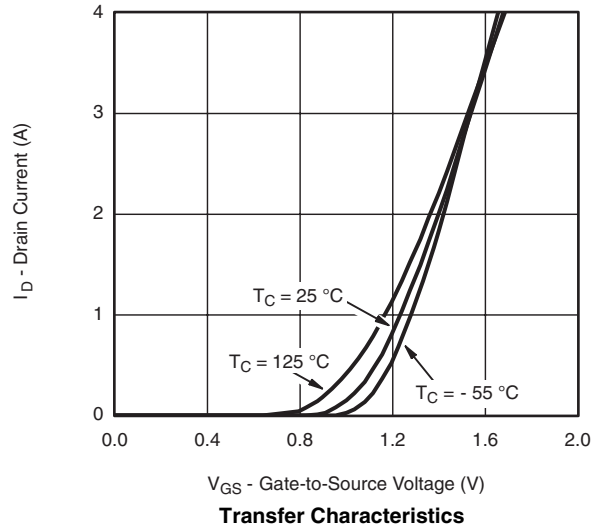
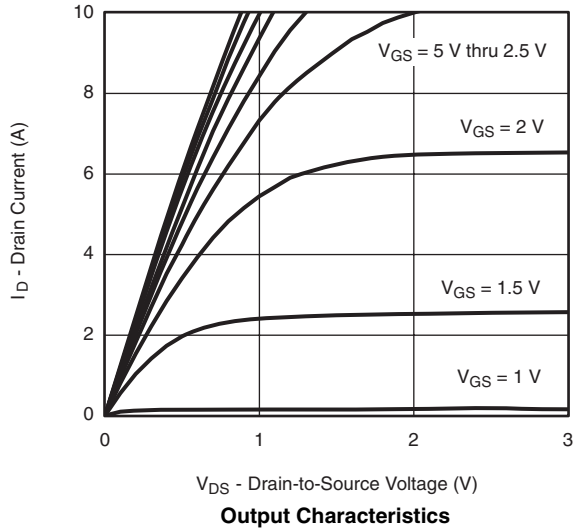

## MOSFET TYPICAL CHARACTERISTICS 25 °C, unless otherwise noted

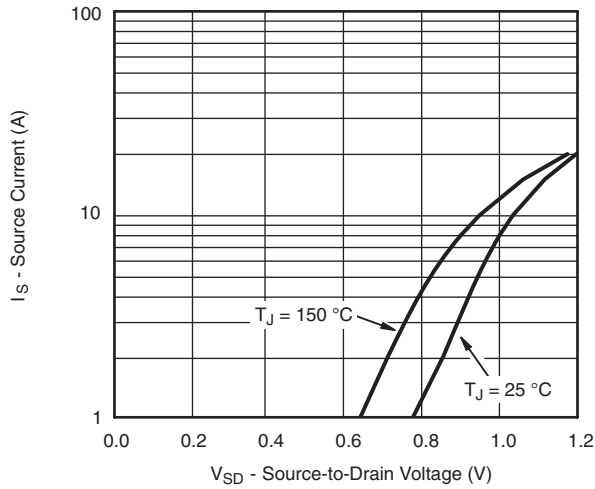

Source-Drain Diode Forward Voltage

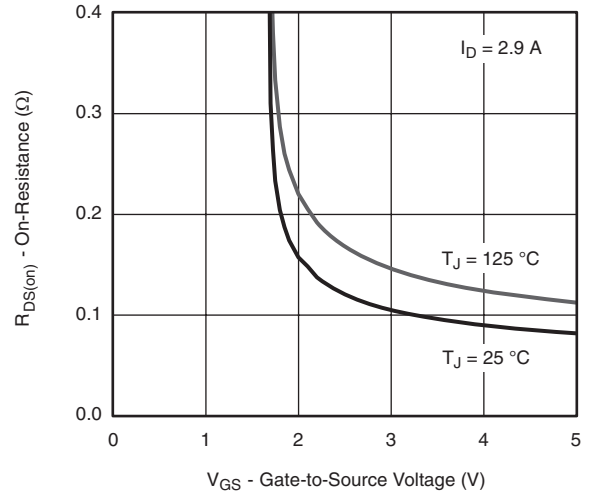

On-Resistance vs. Gate-to-Source Voltage

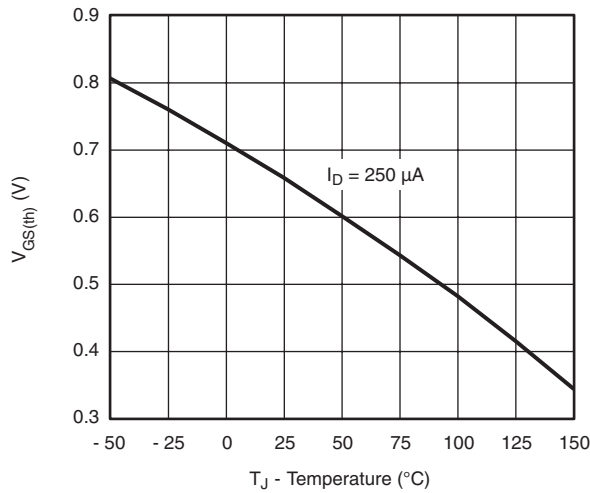

Threshold Voltage

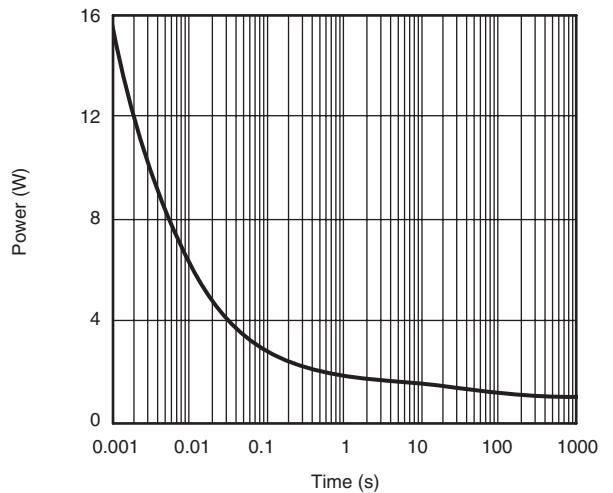

Single Pulse Power, Junction-to-Ambient

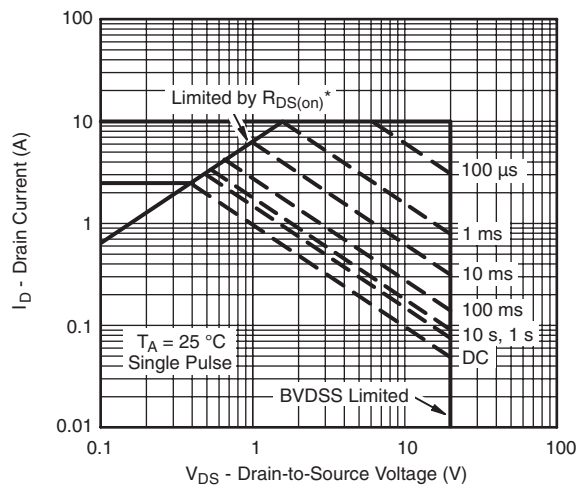

\*  $V_{GS} >$  minimum  $V_{GS}$  at which  $R_{DS(on)}$  is specified

Safe Operating Area, Junction-to-Ambient

**MOSFET TYPICAL CHARACTERISTICS** 25 °C, unless otherwise noted

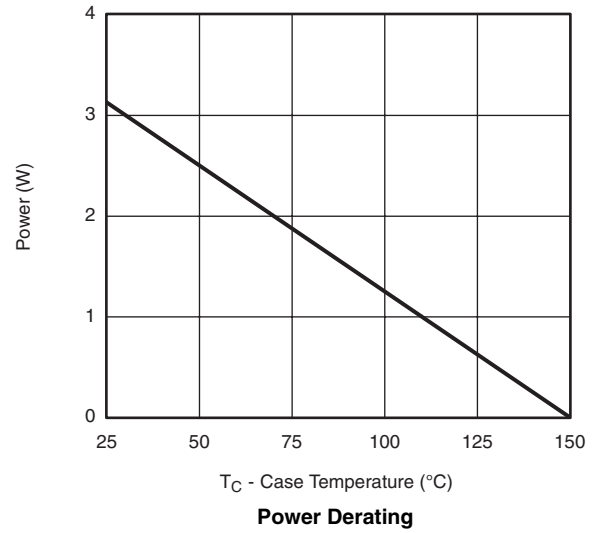
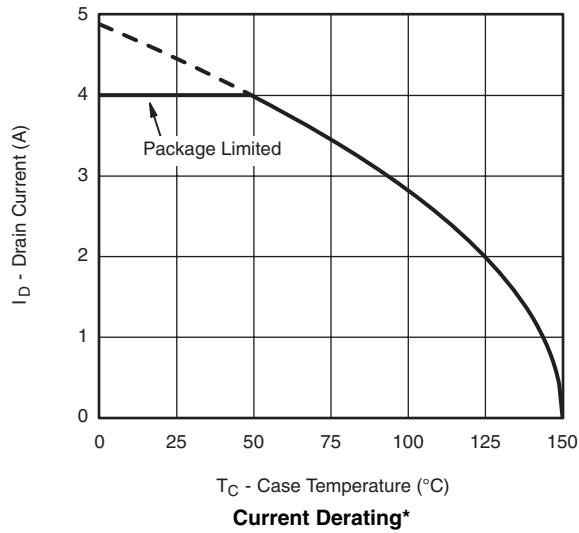

\* The power dissipation  $P_D$  is based on  $T_{J(max)} = 150$  °C, using junction-to-case thermal resistance, and is more useful in settling the upper dissipation limit for cases where additional heatsinking is used. It is used to determine the current rating, when this rating falls below the package limit.

**MOSFET TYPICAL CHARACTERISTICS** 25 °C, unless otherwise noted

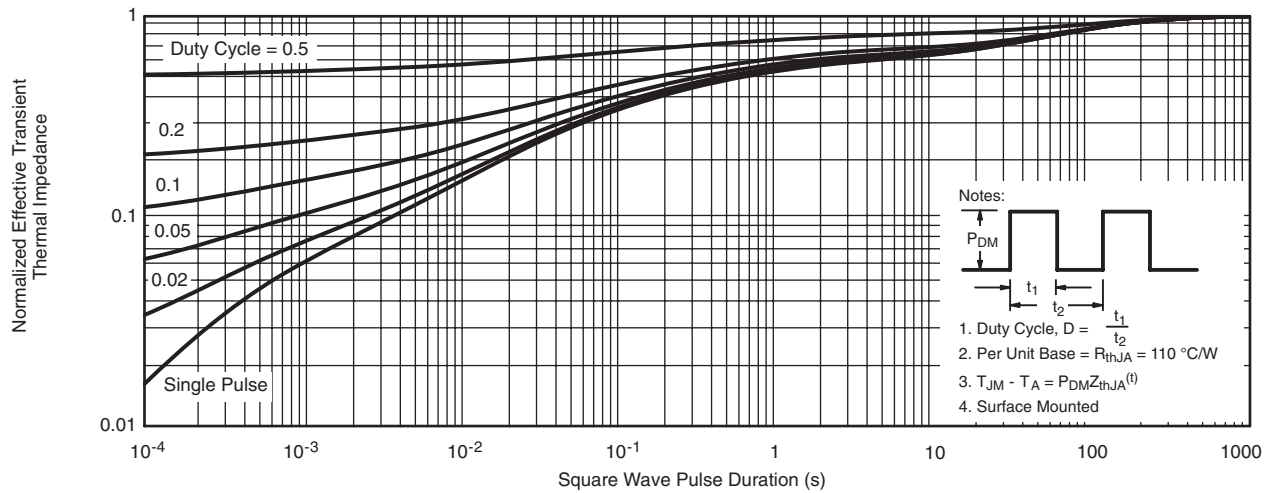

**Normalized Thermal Transient Impedance, Junction-to-Ambient**

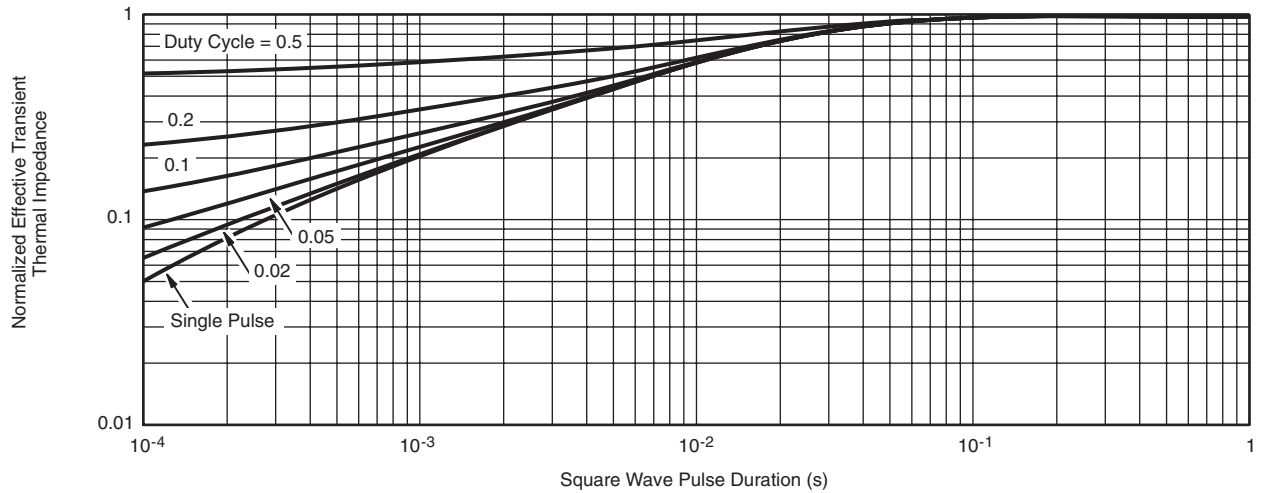

**Normalized Thermal Transient Impedance, Junction-to-Foot**

**SCHOTTKY TYPICAL CHARACTERISTICS** 25 °C, unless otherwise noted

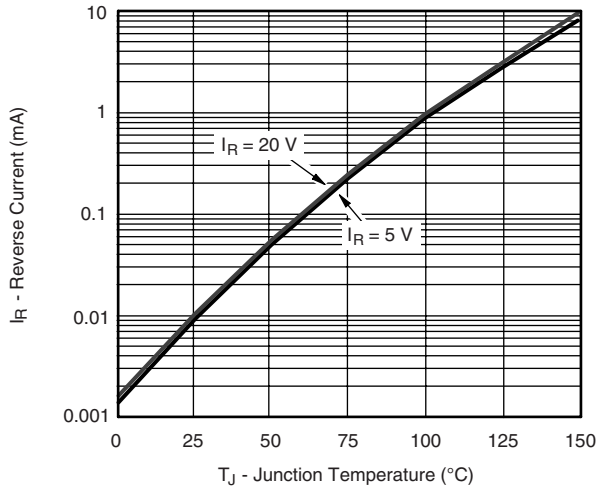

**Reverse Current vs. Junction Temperature**

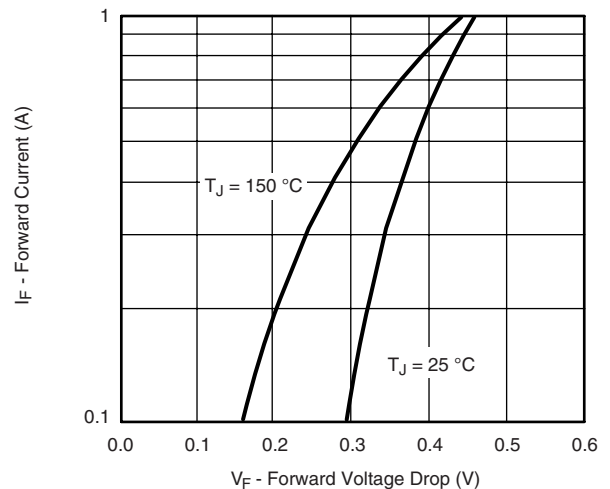

**Forward Voltage Drop**

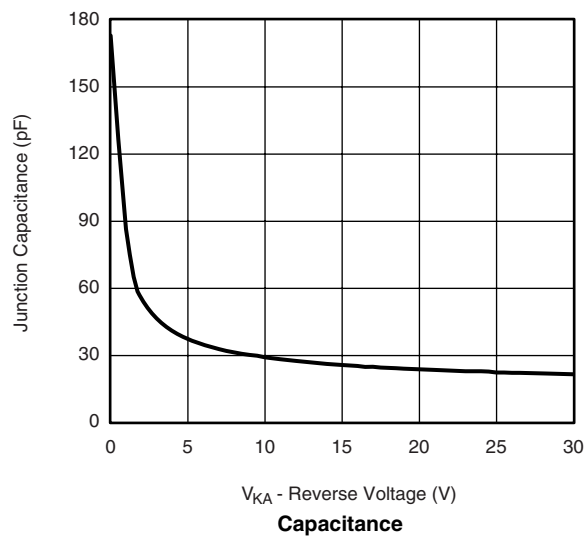

**Capacitance**



**SCHOTTKY TYPICAL CHARACTERISTICS** 25 °C, unless otherwise noted

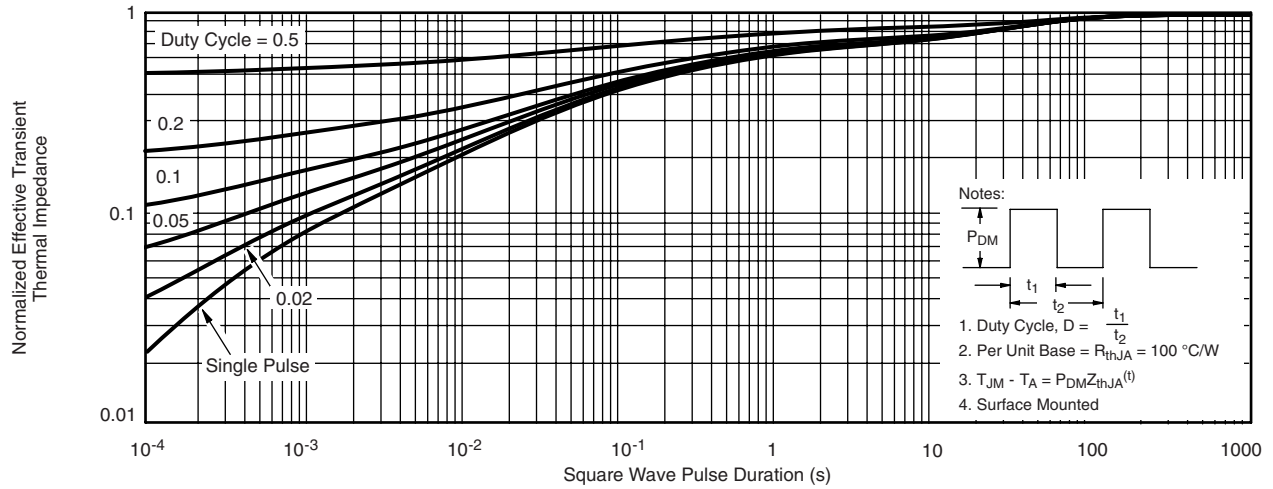

**Normalized Thermal Transient Impedance, Junction-to-Ambient**

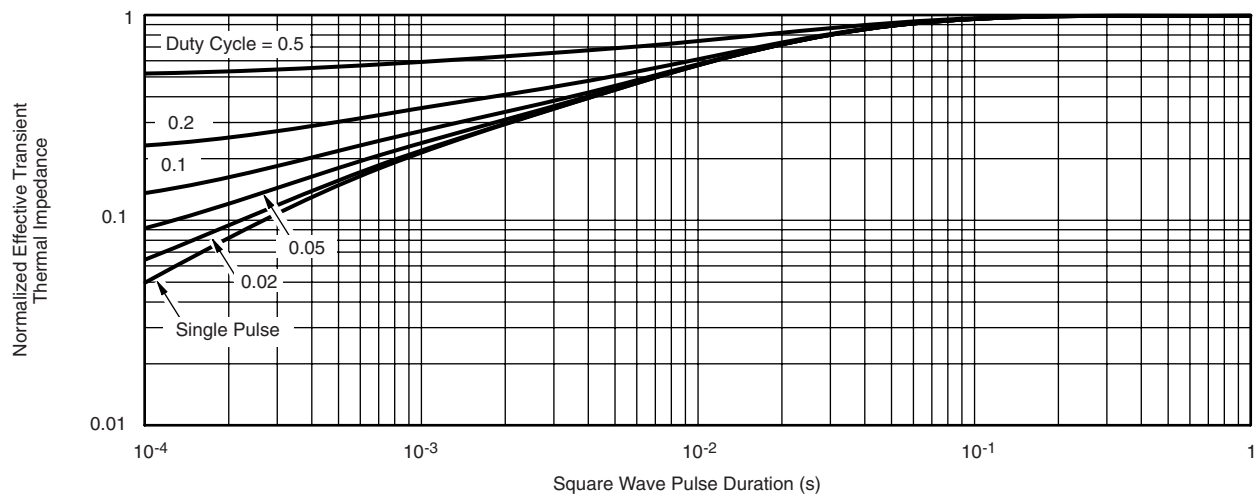

**Normalized Thermal Transient Impedance, Junction-to-Foot**

Vishay Siliconix maintains worldwide manufacturing capability. Products may be manufactured at one of several qualified locations. Reliability data for Silicon Technology and Package Reliability represent a composite of all qualified locations. For related documents such as package/tape drawings, part marking, and reliability data, see [www.vishay.com/ppg?68979](http://www.vishay.com/ppg?68979).

### 1206-8 ChipFET®

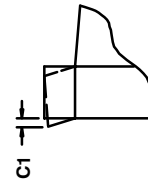
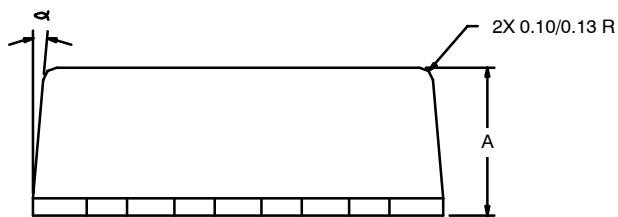
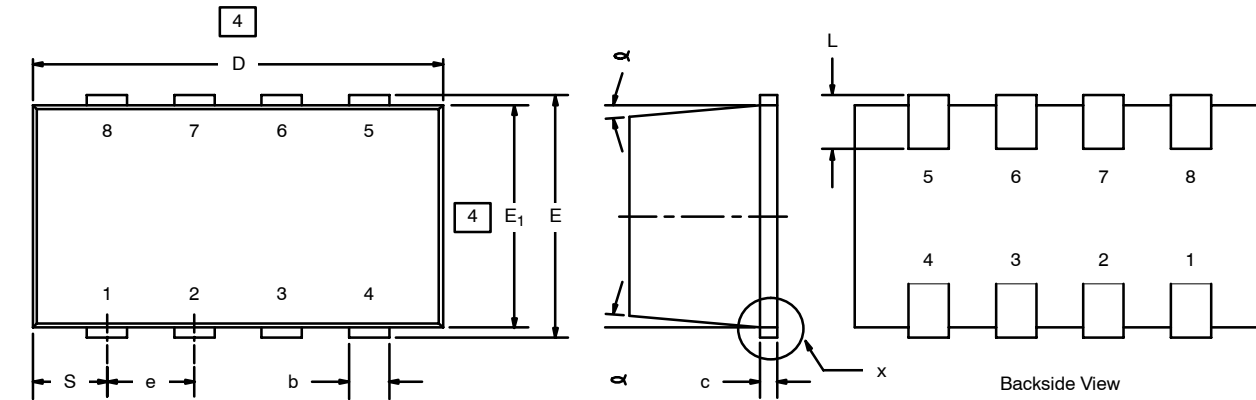

DETAIL X

**NOTES:**

1. All dimensions are in millimeters.
2. Mold gate burrs shall not exceed 0.13 mm per side.
3. Leadframe to molded body offset is horizontal and vertical shall not exceed 0.08 mm.

**4.** Dimensions exclusive of mold gate burrs.

5. No mold flash allowed on the top and bottom lead surface.

Dim	MILLIMETERS			INCHES		
	Min	Nom	Max	Min	Nom	Max
<b>A</b>	1.00	—	1.10	0.039	—	0.043
<b>b</b>	0.25	0.30	0.35	0.010	0.012	0.014
<b>c</b>	0.1	0.15	0.20	0.004	0.006	0.008
<b>c1</b>	0	—	0.038	0	—	0.0015
<b>D</b>	2.95	3.05	3.10	0.116	0.120	0.122
<b>E</b>	1.825	1.90	1.975	0.072	0.075	0.078
<b>E<sub>1</sub></b>	1.55	1.65	1.70	0.061	0.065	0.067
<b>e</b>	0.65 BSC			0.0256 BSC		
<b>L</b>	0.28	—	0.42	0.011	—	0.017
<b>S</b>	0.55 BSC			0.022 BSC		
<b>α</b>	5°Nom			5°Nom		
ECN: C-03528—Rev. F, 19-Jan-04 DWG: 5547						

## RECOMMENDED MINIMUM PADS FOR 1206-8 ChipFET®

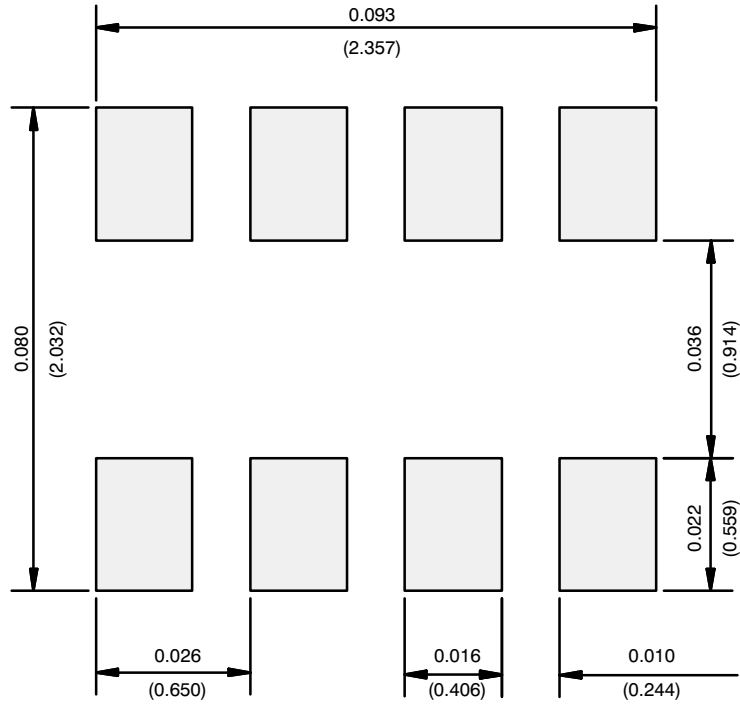

Recommended Minimum Pads  
Dimensions in Inches/(mm)

[Return to Index](#)



## **Disclaimer**

ALL PRODUCT, PRODUCT SPECIFICATIONS AND DATA ARE SUBJECT TO CHANGE WITHOUT NOTICE TO IMPROVE RELIABILITY, FUNCTION OR DESIGN OR OTHERWISE.

Vishay Intertechnology, Inc., its affiliates, agents, and employees, and all persons acting on its or their behalf (collectively, "Vishay"), disclaim any and all liability for any errors, inaccuracies or incompleteness contained in any datasheet or in any other disclosure relating to any product.

Vishay makes no warranty, representation or guarantee regarding the suitability of the products for any particular purpose or the continuing production of any product. To the maximum extent permitted by applicable law, Vishay disclaims (i) any and all liability arising out of the application or use of any product, (ii) any and all liability, including without limitation special, consequential or incidental damages, and (iii) any and all implied warranties, including warranties of fitness for particular purpose, non-infringement and merchantability.

Statements regarding the suitability of products for certain types of applications are based on Vishay's knowledge of typical requirements that are often placed on Vishay products in generic applications. Such statements are not binding statements about the suitability of products for a particular application. It is the customer's responsibility to validate that a particular product with the properties described in the product specification is suitable for use in a particular application. Parameters provided in datasheets and / or specifications may vary in different applications and performance may vary over time. All operating parameters, including typical parameters, must be validated for each customer application by the customer's technical experts. Product specifications do not expand or otherwise modify Vishay's terms and conditions of purchase, including but not limited to the warranty expressed therein.

Except as expressly indicated in writing, Vishay products are not designed for use in medical, life-saving, or life-sustaining applications or for any other application in which the failure of the Vishay product could result in personal injury or death. Customers using or selling Vishay products not expressly indicated for use in such applications do so at their own risk. Please contact authorized Vishay personnel to obtain written terms and conditions regarding products designed for such applications.

No license, express or implied, by estoppel or otherwise, to any intellectual property rights is granted by this document or by any conduct of Vishay. Product names and markings noted herein may be trademarks of their respective owners.